



ADA-X4YZ External 3 in 1 Combination Antenna

Feature:

- GNSS / LTE/5G /WiFi / 3 in 1 Combination Antenna
- GPS/GLONASS/Beidou/Galileo/QZSS Supporting
- LTE MIMO or Dual Band WiFi MIMO + Full Band GNSS
- Versatile Combination with up to 3 Cables
- IP69K fully waterproof and ESD Protection
- Magnetic / Adhesive / Screw Mounted Options
- Cable & Connector are customizable
- **E-mark & ECE R118-03 certified**

Application:

- Vehicle Tracking and Telematics
- Machine to Machine Communication and IoT
- Asset and Remote Monitoring
- Public Transport Systems

RoHS/Reach

Specifications:

Category	GNSS		
Passive Antenna Performance			
Application Band	BeiDou	GPS	GLONASS
Frequency (MHz)	1561	1575.42	1602
Efficiency (%)	49.89	42.76	58.61
Average Gain (dBi)	-3.02	-3.69	-2.32
Peak Gain (dBi)	1.21	1.21	1.44
V.S.W.R	< 2		
Return loss (dB)	< -10		
Impedance (Ω)	50		
Polarization	R.H.C.P. (Right Handed Circular Polarization)		
Active Antenna Performance			
Application band	BeiDou	GPS	GLONASS
Frequency (MHz)	1561 \pm 2.046	1575.42 \pm 1.023	1602 \pm 5
Gain (dB)	27	27	27
Noise (dB)	0.98	0.98	0.92
Current Consumption	9.0mA (typical)		
Output Impedance (Ω)	50		
GNSS _Out of Band Rejection			
Frequency (MHz)	600 ~ 1300	1300 ~ 1530	1650 ~ 3000
Gain (dB)	55	30	30
ESD Protection	+/- 8 KV (direct discharge) +/- 15KV (air discharge)		
Cable/Connector	H-100 / SMA(Male)		

Category		LTE MIMO1						
Application Band	LTE 700	GSM 850/900	DCS	PCS	UMTS1	LTE2600	5G NR Band	
Frequency (MHz)	698 ~ 824	824 ~ 960	1710 ~ 1880	1850 ~ 1990	1920 ~ 2170	2300 ~ 2690	3300 ~ 3800	
Efficiency (%)								
Free Space	30cm	27.06	17.96	50.82	51.25	50.65	45.58	48.04
	1m	26.33	17.42	48.75	49.13	48.40	43.13	45.15
	2m	24.01	15.73	42.46	42.68	41.59	35.87	36.70
	3m	21.90	14.21	36.98	37.08	35.74	29.84	29.83
	5m	18.21	11.60	28.05	27.98	26.39	20.64	19.71
With 30*30cm Ground Plane	30cm	47.56	20.00	47.84	57.06	46.93	39.46	51.79
	1m	46.27	19.40	45.90	54.70	44.84	37.34	48.67
	2m	42.20	17.52	39.97	47.52	38.53	31.05	39.56
	3m	38.48	15.83	34.82	41.28	33.11	25.83	32.16
	5m	32.01	12.91	26.41	31.16	24.45	17.87	21.24
Average Gain (dBi)								
Free Space	30cm	-5.68	-7.46	-2.94	-2.90	-2.95	-3.41	-3.18
	1m	-5.80	-7.59	-3.12	-3.09	-3.15	-3.65	-3.45
	2m	-6.20	-8.03	-3.72	-3.70	-3.81	-4.45	-4.35
	3m	-6.60	-8.47	-4.32	-4.31	-4.47	-5.25	-5.25
	5m	-7.40	-9.36	-5.52	-5.53	-5.79	-6.85	-7.05
With 30*30cm Ground Plane	30cm	-3.23	-6.99	-3.20	-2.44	-3.29	-4.04	-2.86
	1m	-3.35	-7.12	-3.38	-2.62	-3.48	-4.28	-3.13
	2m	-3.75	-7.56	-3.98	-3.23	-4.14	-5.08	-4.03
	3m	-4.15	-8.01	-4.58	-3.84	-4.80	-5.88	-4.93
	5m	-4.95	-8.89	-5.78	-5.06	-6.12	-7.48	-6.73

Peak Gain (dBi)								
Free Space	30cm	0.92	-1.60	3.08	3.37	3.37	3.80	1.96
	1m	0.80	-1.72	2.90	3.19	3.19	3.56	1.69
	2m	0.40	-2.12	2.30	2.59	2.59	2.76	0.79
	3m	0.00	-2.52	1.70	1.99	1.99	1.96	-0.11
	5m	-0.80	-3.32	0.50	0.79	0.79	0.36	-1.91
With 30*30cm Ground Plane	30cm	4.40	3.03	4.21	4.85	4.85	5.58	5.75
	1m	4.28	2.91	4.03	4.67	4.67	5.34	5.48
	2m	3.88	2.51	3.43	4.07	4.07	4.54	4.58
	3m	3.48	2.11	2.83	3.47	3.47	3.74	3.68
	5m	2.68	1.31	1.63	2.27	2.27	2.14	1.88
V.S.W.R								
Free Space	< 5.85			< 3				
With 30*30cm Ground Plane	< 5.85			< 3				
Return Loss (dB)								
Free Space	< -3			< -6				
With 30*30cm Ground Plane	< -3			< -6				
Impedance (Ω)	50							
Polarization	Linear							
Cable	H100							
Connector	SMA (Male)							

Category		LTE MIMO2						
Application Band	LTE 700	GSM 850/900	DCS	PCS	UMTS1	LTE2600	5G NR Band	
Frequency (MHz)	698 ~ 824	824 ~ 960	1710 ~ 1880	1850 ~ 1990	1920 ~ 2170	2300 ~ 2690	3300 ~ 3800	
Efficiency (%)								
Free Space	30cm	31.15	37.08	43.66	51.52	55.45	52.73	49.15
	1m	30.30	35.96	41.89	49.39	52.99	49.90	46.18
	2m	27.64	32.48	36.48	42.91	45.53	41.50	37.54
	3m	25.21	29.34	31.78	37.28	39.13	34.52	30.51
	5m	20.97	23.94	24.11	28.13	28.90	23.88	20.16
With 30*30cm Ground Plane	30cm	36.02	43.29	42.79	63.47	59.98	40.42	49.15
	1m	35.03	41.99	41.05	60.84	57.31	38.25	46.18
	2m	31.95	37.93	35.75	52.86	49.25	31.81	37.54
	3m	29.14	34.26	31.14	45.92	42.32	26.46	30.51
	5m	24.24	27.96	23.62	34.66	31.25	18.31	20.16
Average Gain (dBi)								
Free Space	30cm	-5.07	-4.31	-3.60	-2.88	-2.56	-2.78	-3.09
	1m	-5.19	-4.44	-3.78	-3.06	-2.76	-3.02	-3.36
	2m	-5.59	-4.88	-4.38	-3.67	-3.42	-3.82	-4.26
	3m	-5.99	-5.33	-4.98	-4.29	-4.08	-4.62	-5.16
	5m	-6.79	-6.21	-6.18	-5.51	-5.39	-6.22	-6.96
With 30*30cm Ground Plane	30cm	-4.44	-3.64	-3.69	-1.97	-2.22	-3.93	-3.09
	1m	-4.56	-3.77	-3.87	-2.16	-2.42	-4.17	-3.36
	2m	-4.96	-4.21	-4.47	-2.77	-3.08	-4.97	-4.26
	3m	-5.36	-4.65	-5.07	-3.38	-3.73	-5.77	-5.16
	5m	-6.16	-5.54	-6.27	-4.60	-5.05	-7.37	-6.96

Peak Gain (dBi)								
Free Space	30cm	1.59	2.63	2.24	2.63	3.34	3.23	4.96
	1m	1.47	2.51	2.06	2.45	3.13	2.99	4.69
	2m	1.07	2.11	1.46	1.85	2.43	2.19	3.79
	3m	0.67	1.71	0.86	1.25	1.73	1.39	2.89
	5m	-0.13	0.91	-0.34	0.05	0.33	-0.21	1.09
With 30*30cm Ground Plane	30cm	4.09	4.19	3.17	4.52	4.52	4.73	7.55
	1m	3.97	4.07	2.99	4.34	4.34	4.49	7.28
	2m	3.57	3.67	2.39	3.74	3.74	3.69	6.38
	3m	3.17	3.27	1.79	3.14	3.14	2.89	5.48
	5m	2.37	2.47	0.59	1.94	1.94	1.29	3.68
V.S.W.R								
Free Space	< 5.85			< 3				
With 30*30cm Ground Plane	< 5.85			< 3				
Return Loss (dB)								
Free Space	< -3			< -6				
With 30*30cm Ground Plane	< -3			< -6				
Impedance (Ω)	50							
Polarization	Linear							
Cable	H100							
Connector	SMA (Male)							
Dimension (mm)	ϕ 65(D) x 20(H)							
Environmental Conditions								
Operation Temperature	-40 ~ +85 °C							
Storage Temperature	-40 ~ +85 °C							

I. Antenna Technical Parameters:

S11 (dB) - GNSS

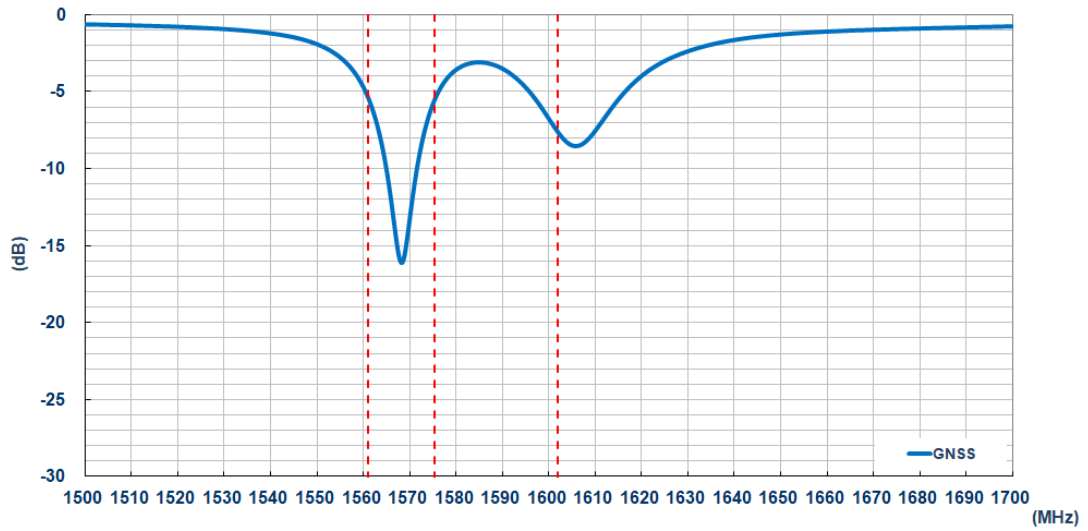

Efficiency (%) - GNSS

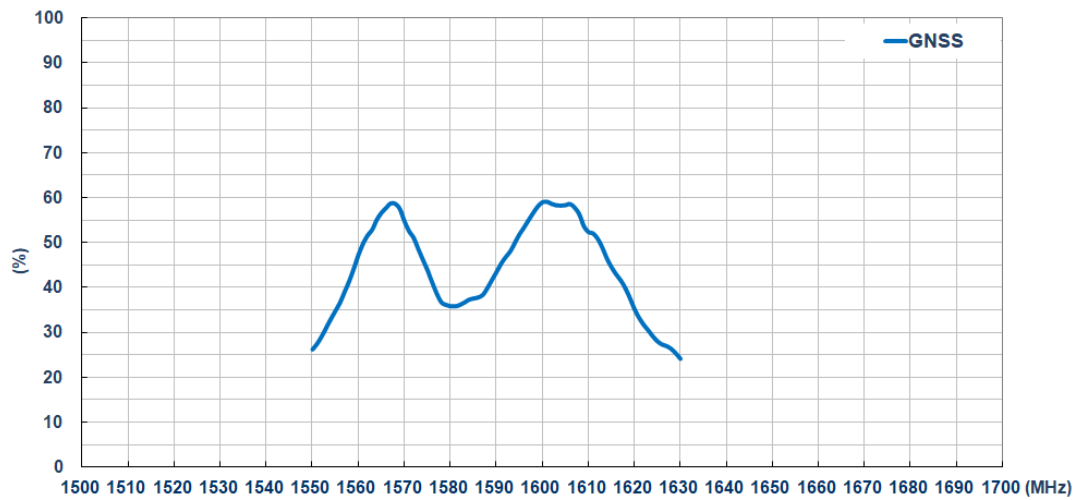

Average Gain (dBi) - GNSS

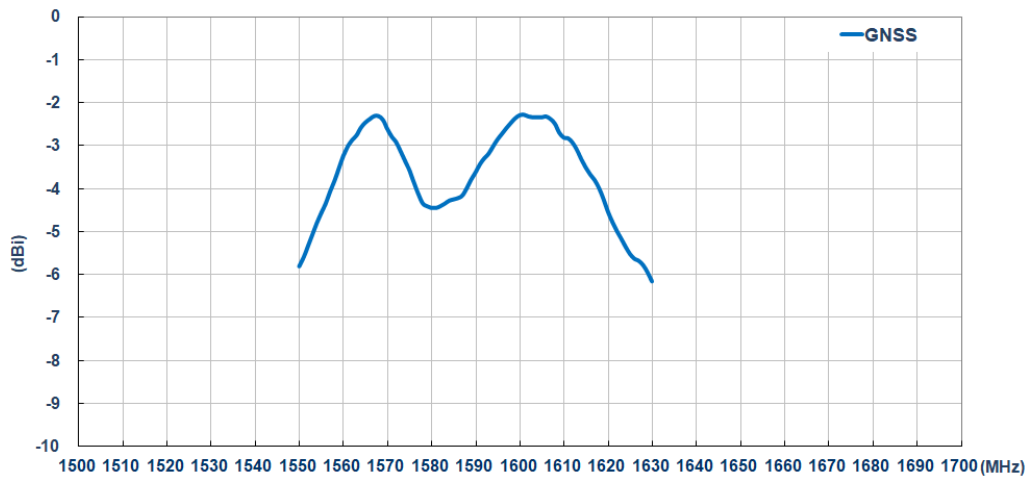

Peak Gain (dBi) – GNSS

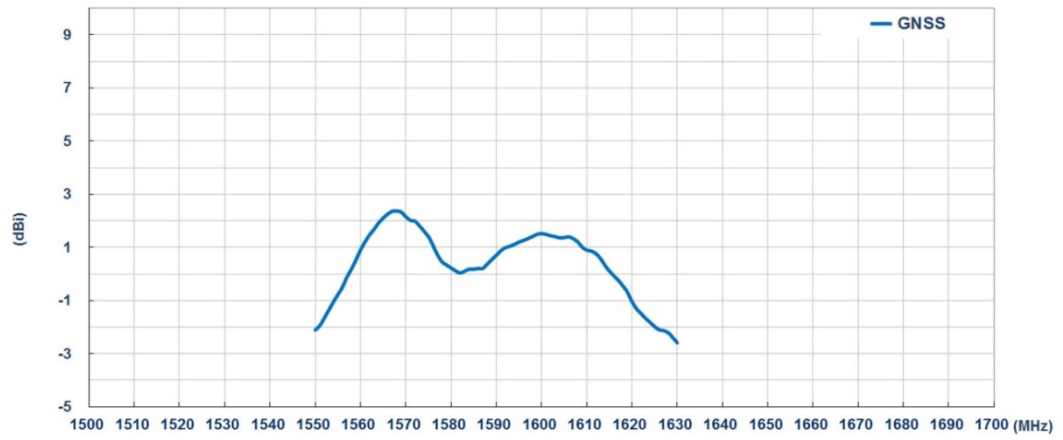

Noise & Gain (dB) - GNSS

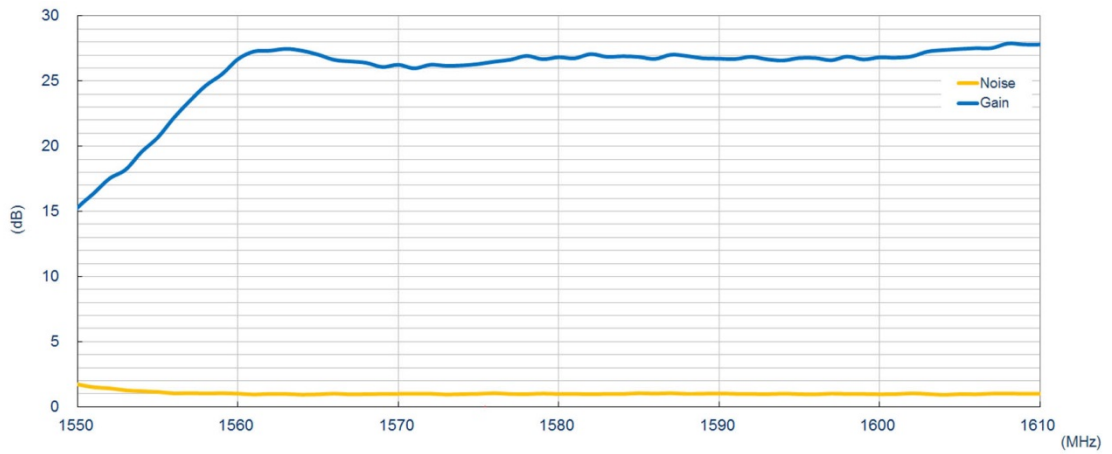

Out of Band Rejection (dB) - GNSS

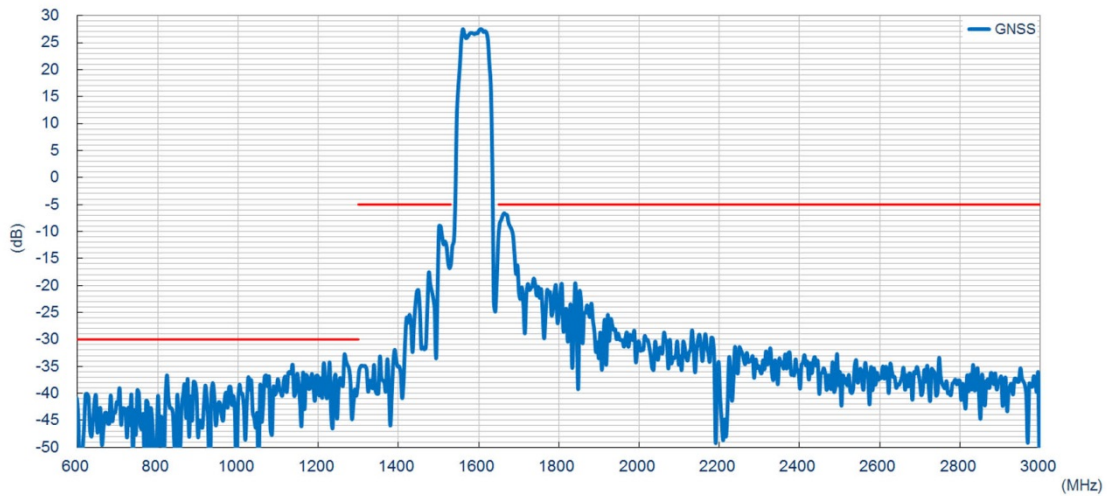

Free Space

S11 (dB) – LTE MIMO1 / LTE MIMO2

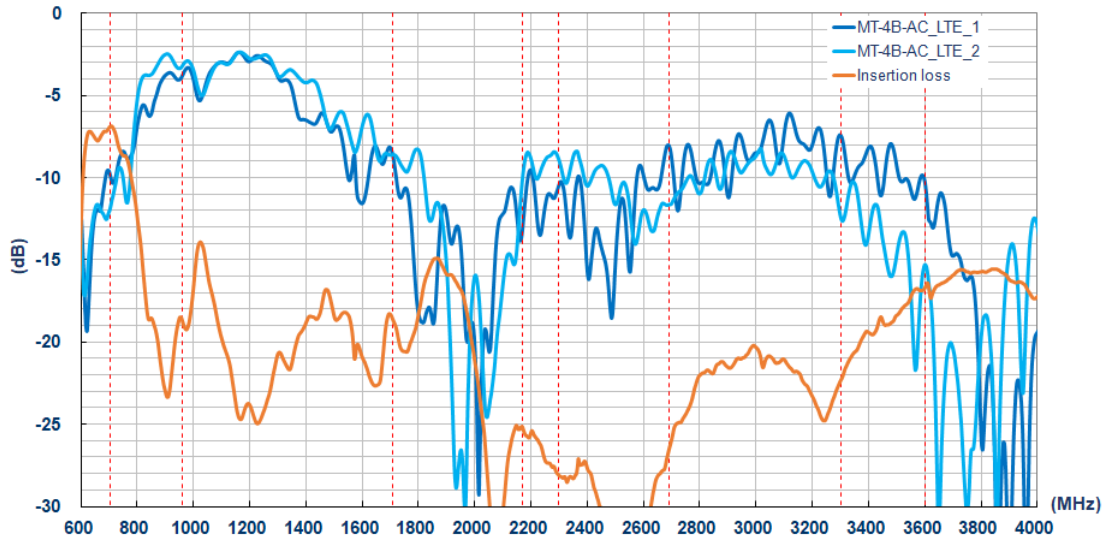

Free Space

Efficiency (%) – LTE MIMO1

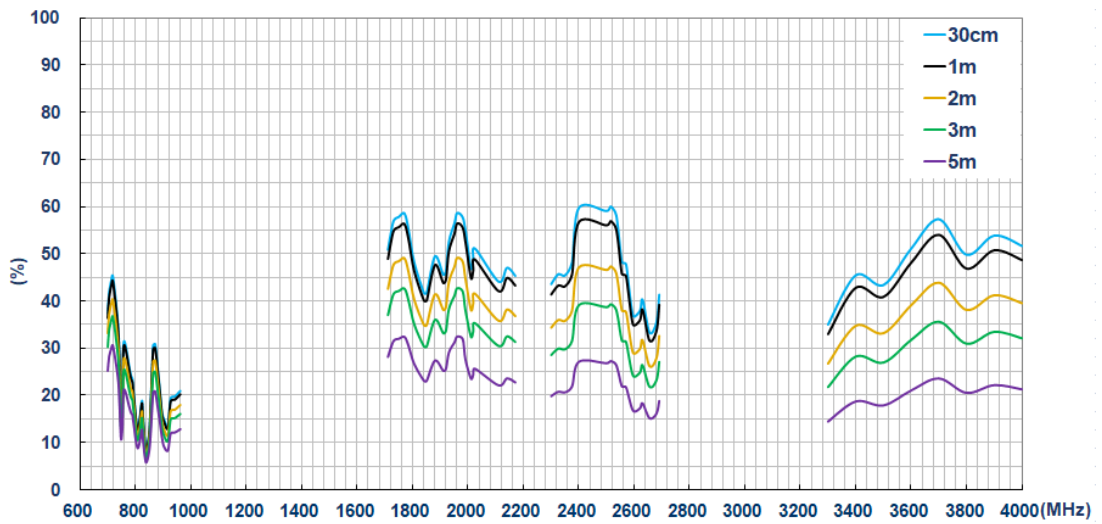

Average Gain (dBi) - LTE MIMO1

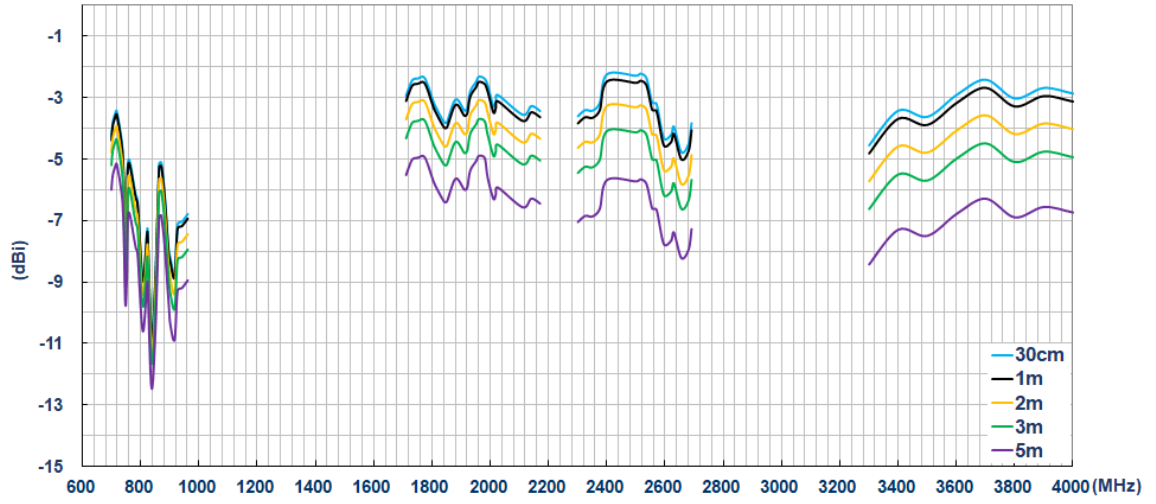

Peak Gain (dBi) - LTE MIMO1

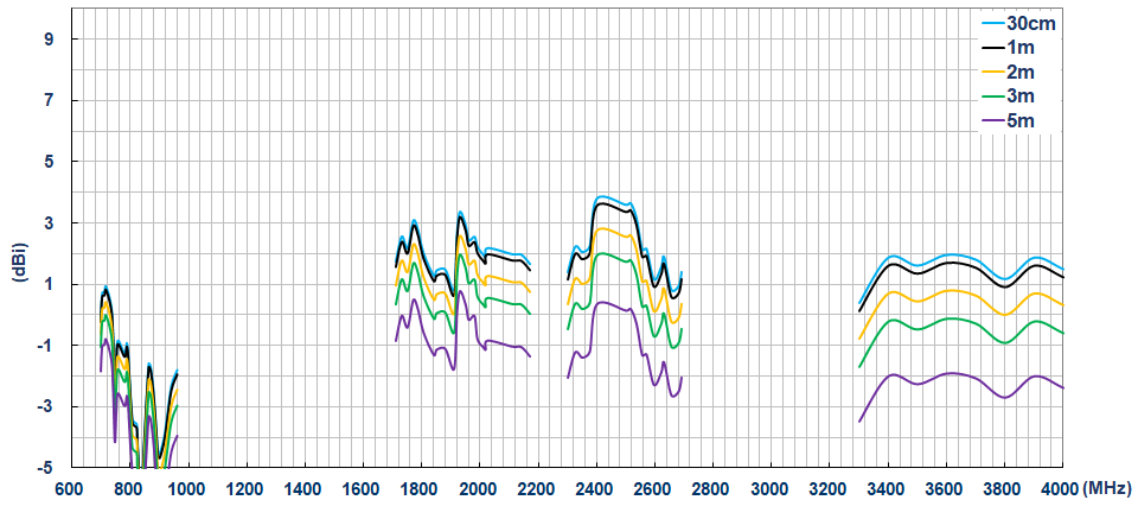

Free Space

Efficiency (%) - LTE MIMO2

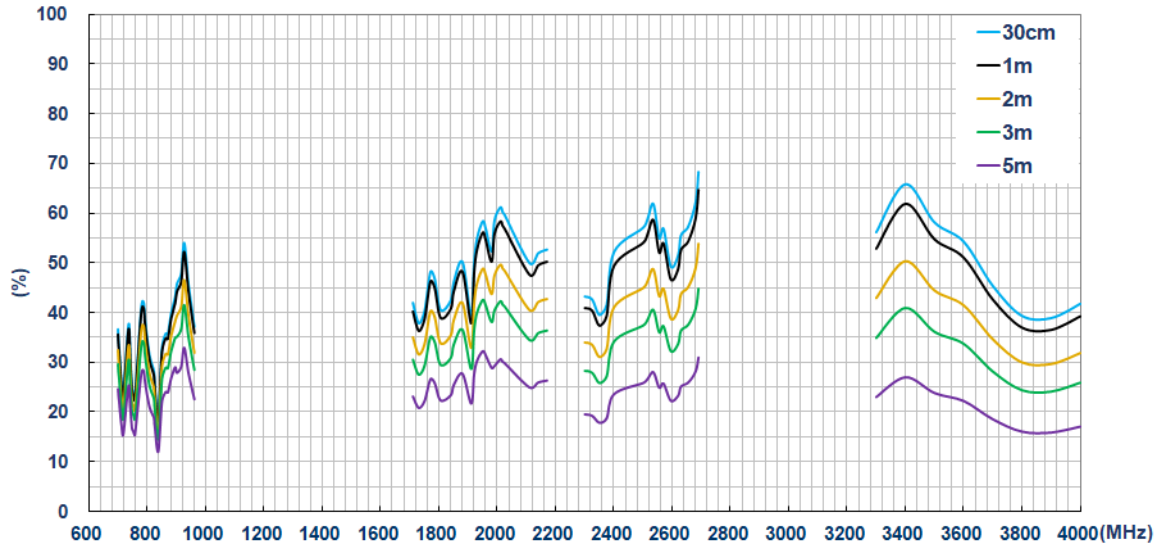

Average Gain (dBi) - LTE MIMO2

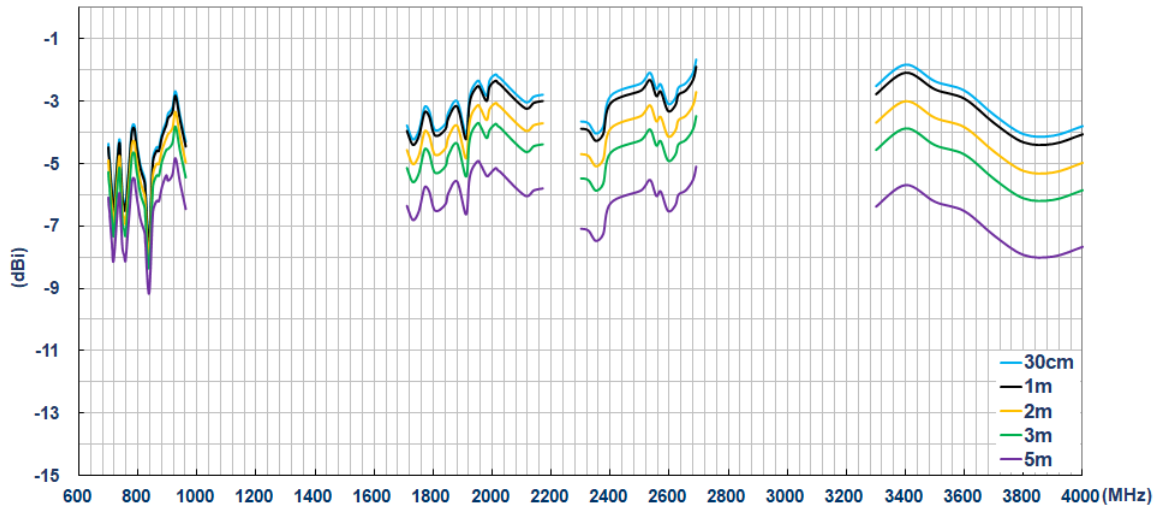

Peak Gain (dBi) -LTE MIMO2

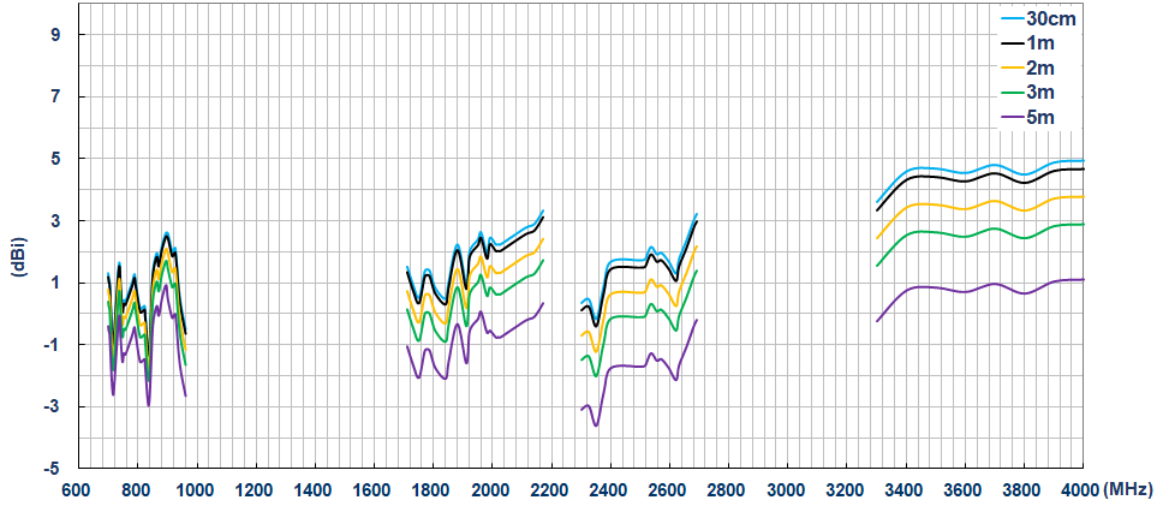

With 30*30cm Ground Plane

S11 (dB) - LTE MIMO1 / LTE MIMO2

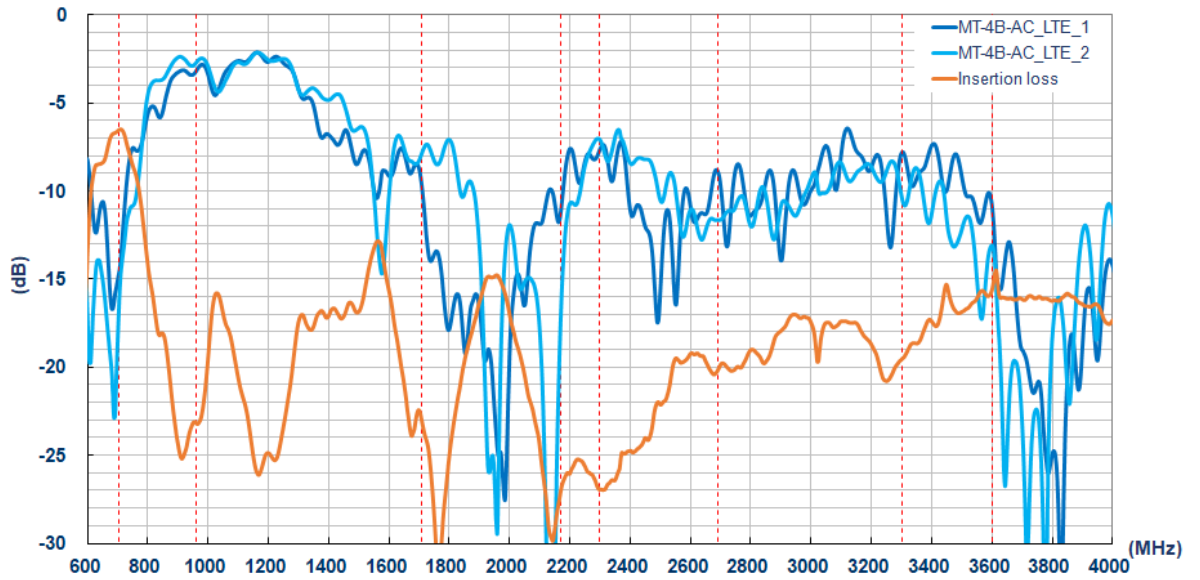

With 30*30cm Ground Plane

Efficiency (%) -LTE MIMO1

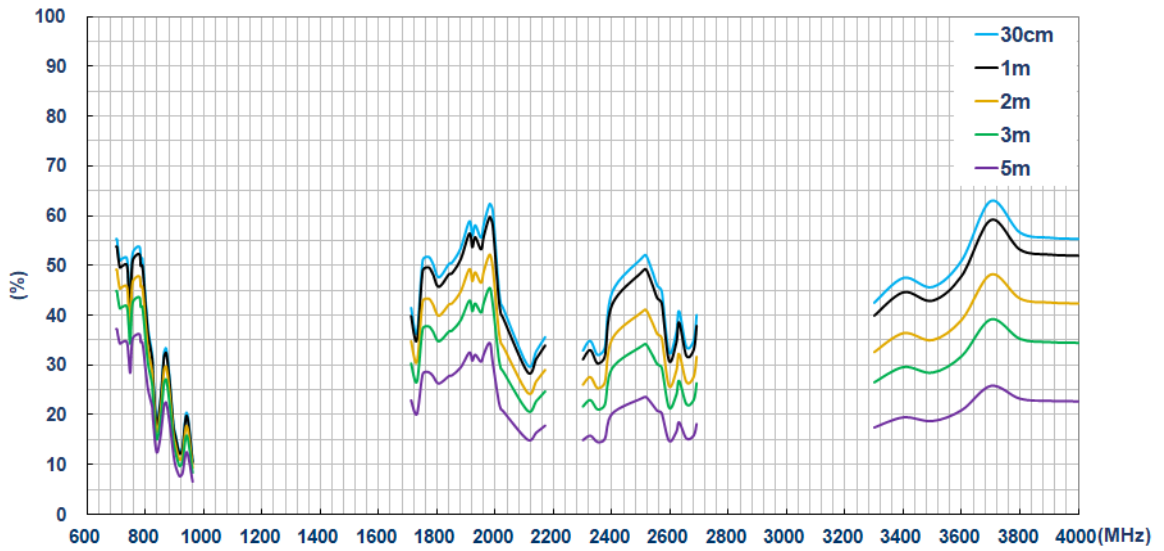

Average Gain (dBi) - LTE MIMO1

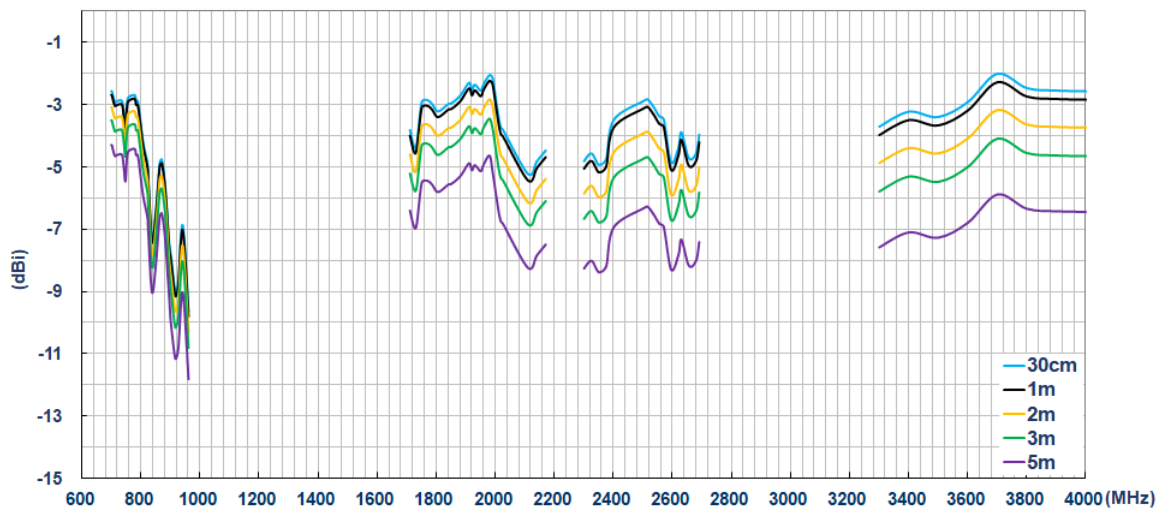

Peak Gain (dBi) –LTE MIMO1

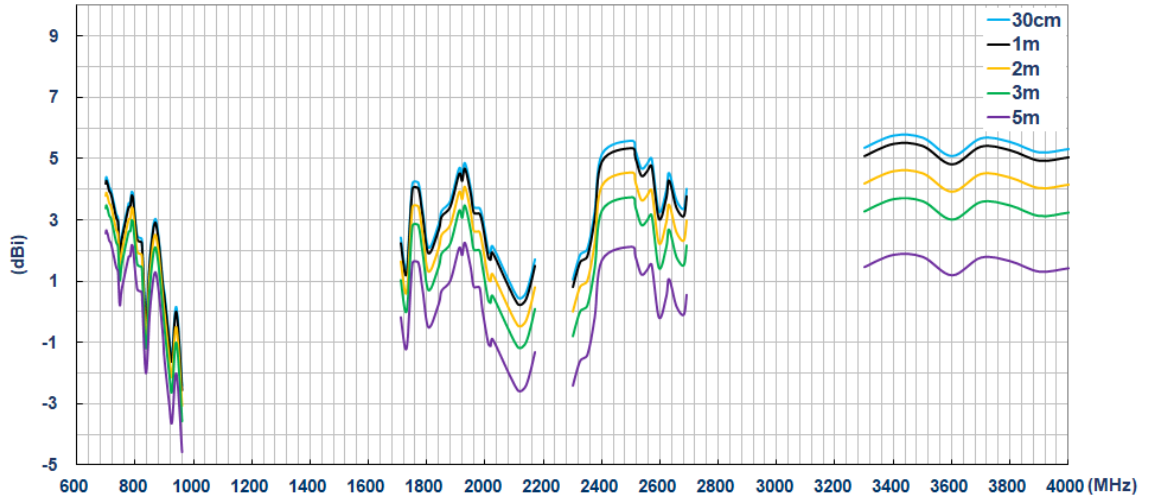

With 30*30cm Ground Plane
Efficiency (%) –LTE MIMO2

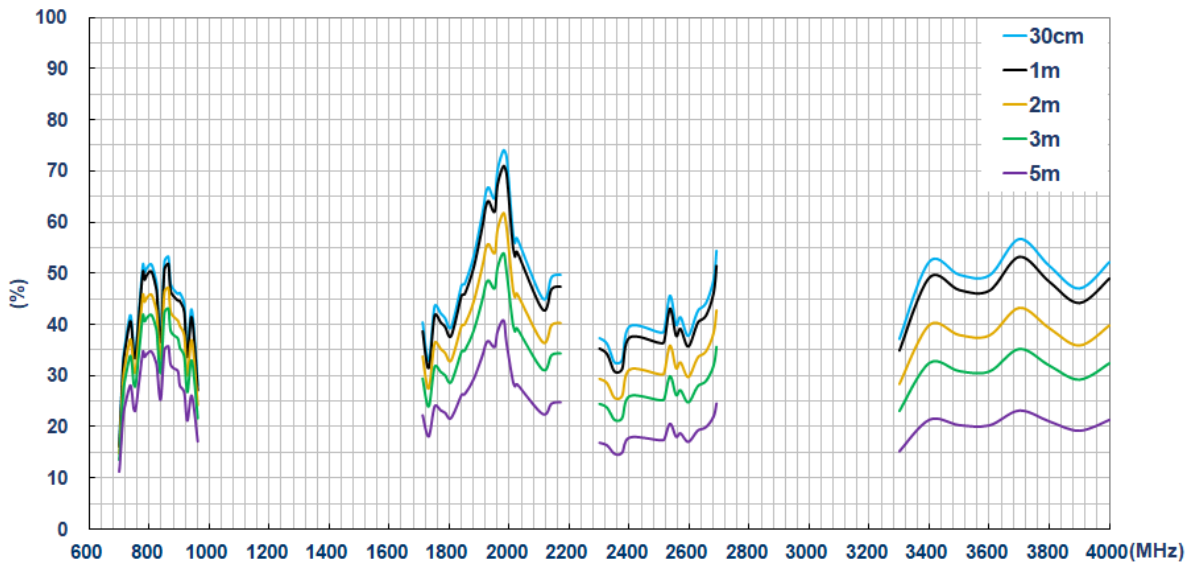

Average Gain (dBi) - LTE MIMO2

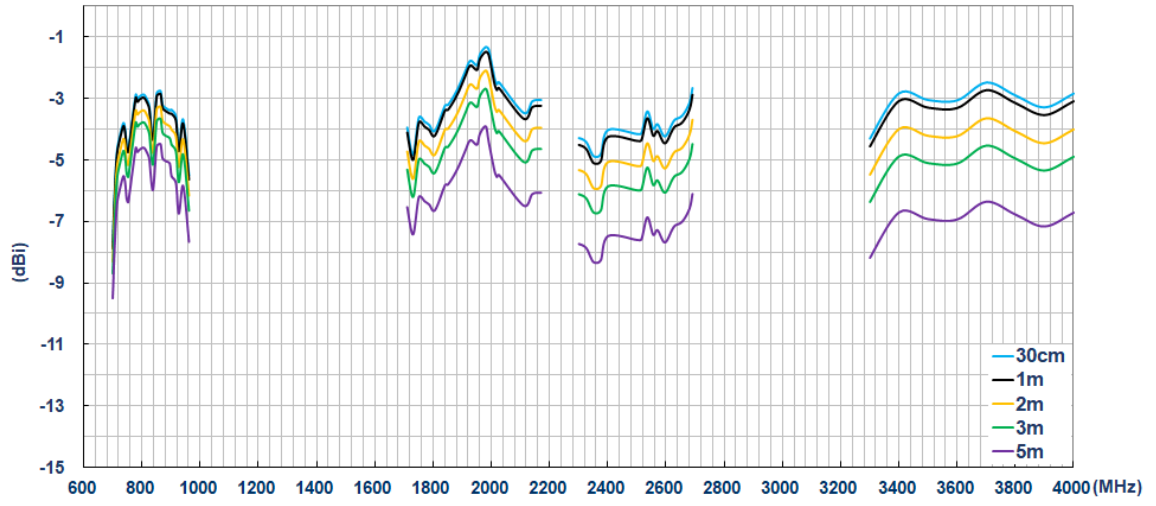

Peak Gain (dBi) - LTE MIMO2

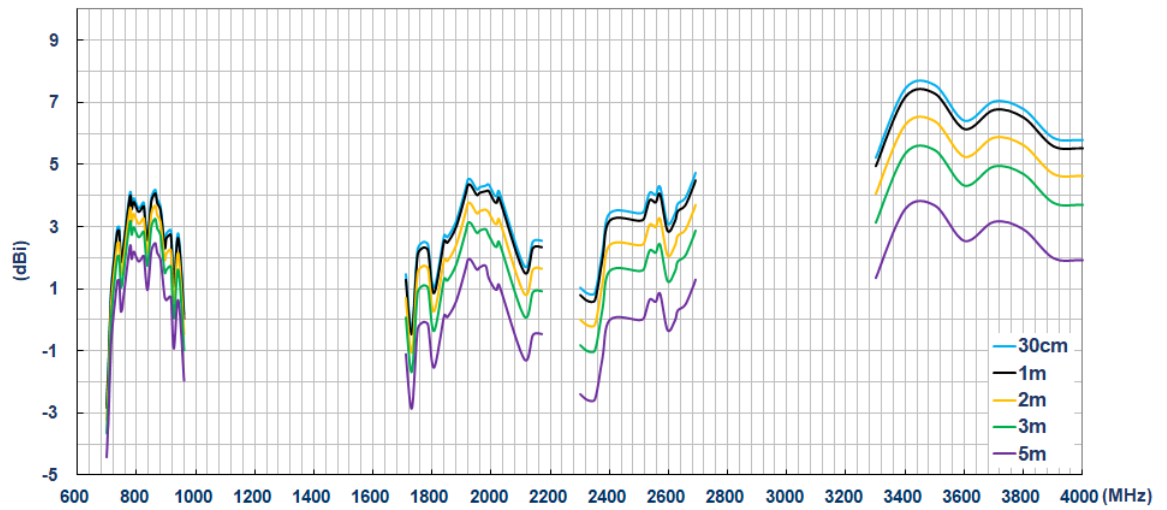

II. Antenna Radiation Pattern Measurement:

The antenna radiation patterns were measured in Anechoic Chamber. The measurement setup as below,

Free Space

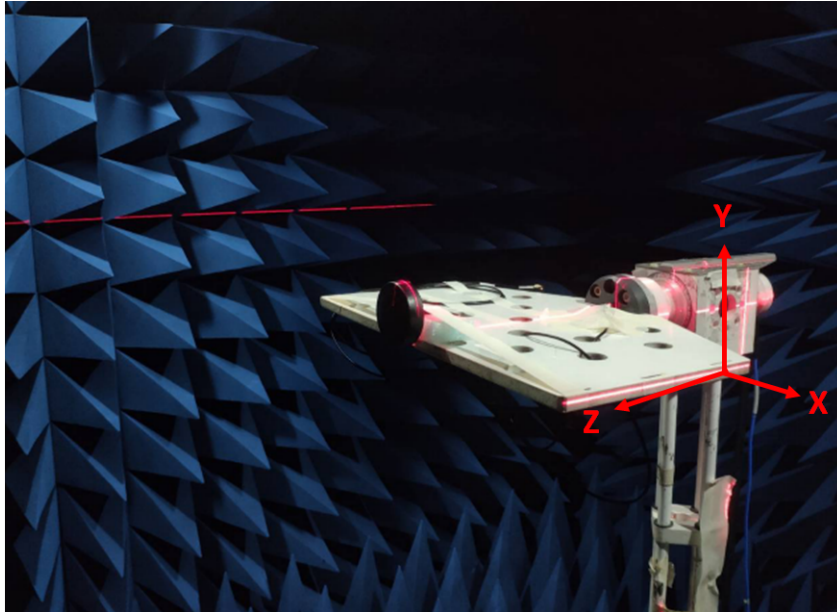

On the 30*30cm Ground Plane

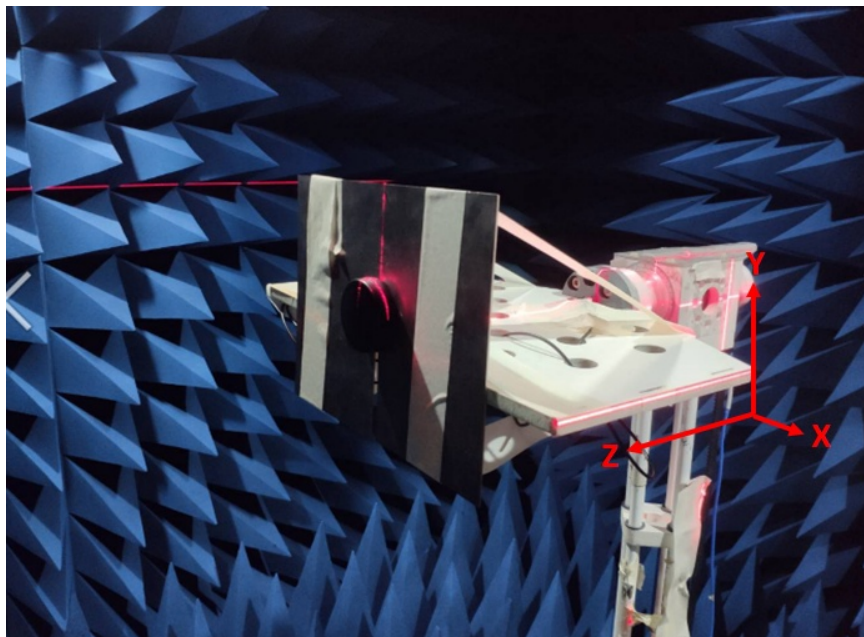

III. 2D Radiation Pattern:

GNSS X-Y Plane

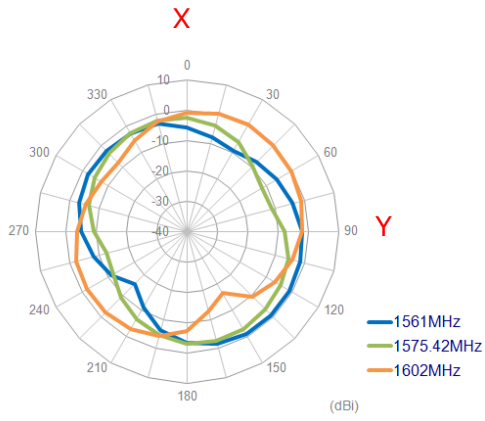

GNSS X-Z Plane

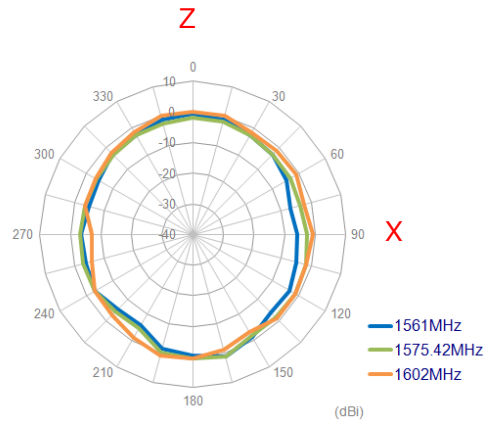

GNSS Y-Z Plane

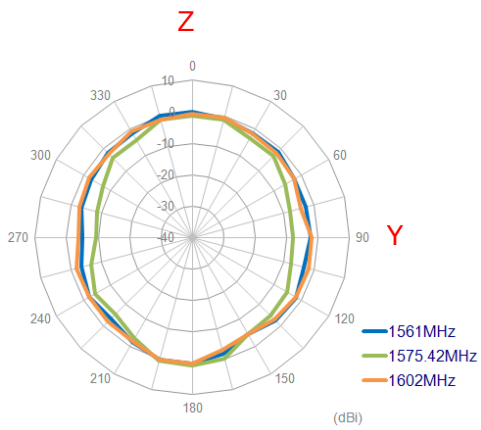

Free Space – LTE MIMO1

X-Y Plane

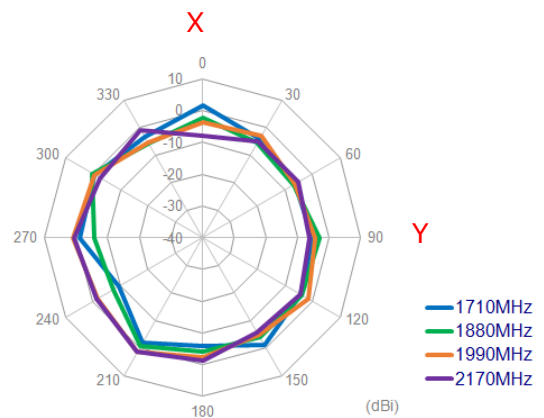
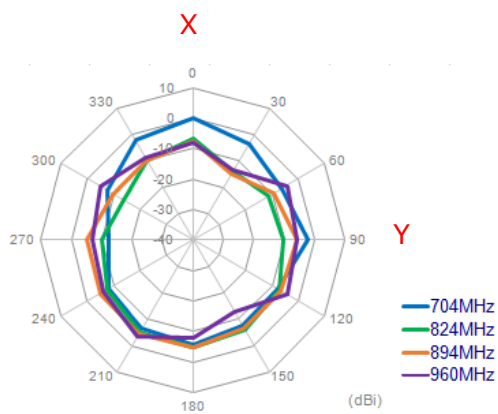

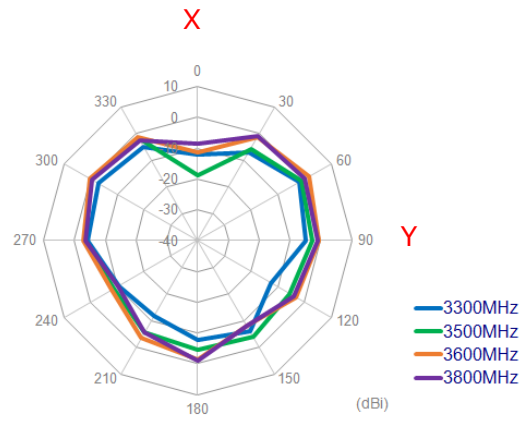
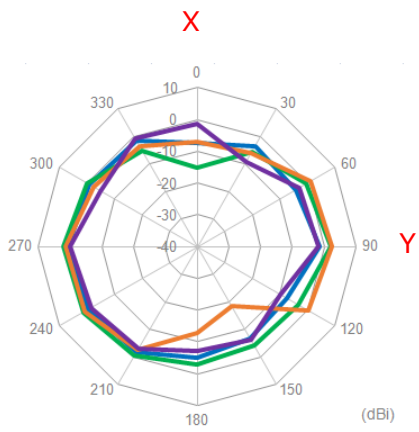

X-Z Plane

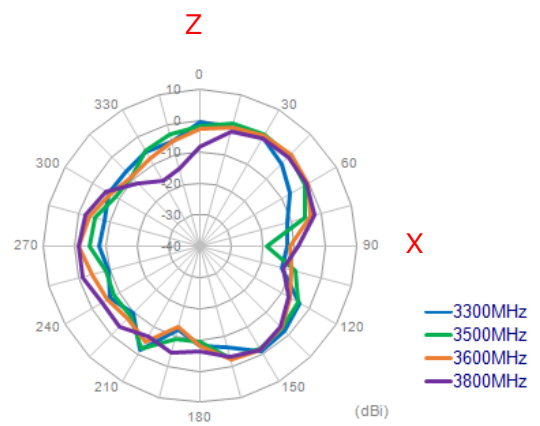
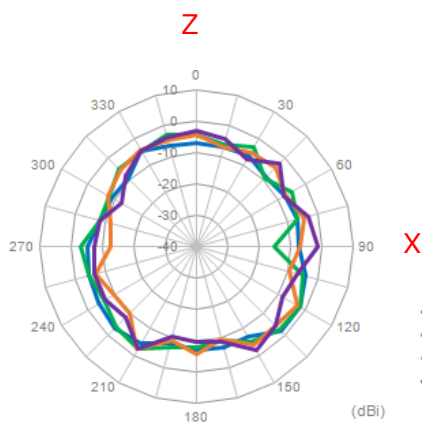
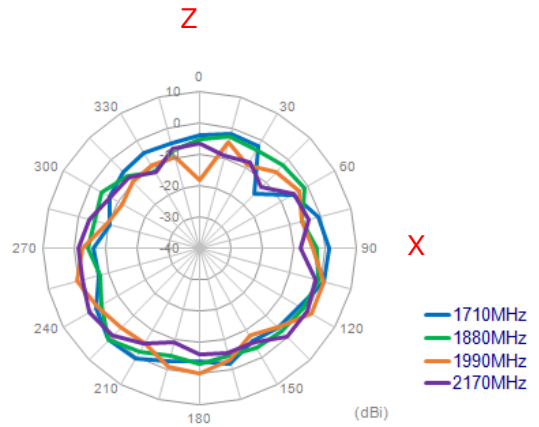
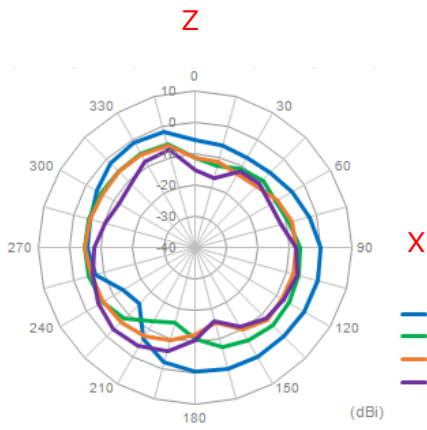

Y-Z Plane

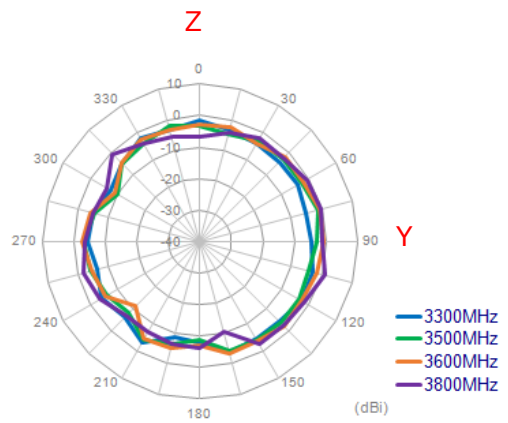
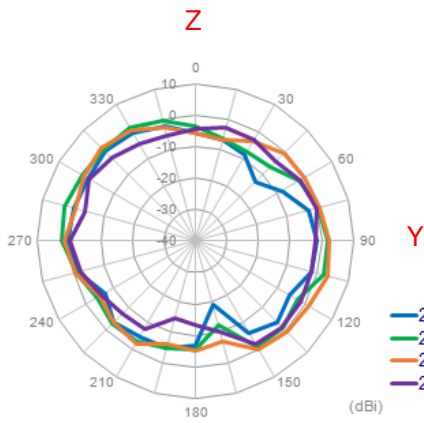
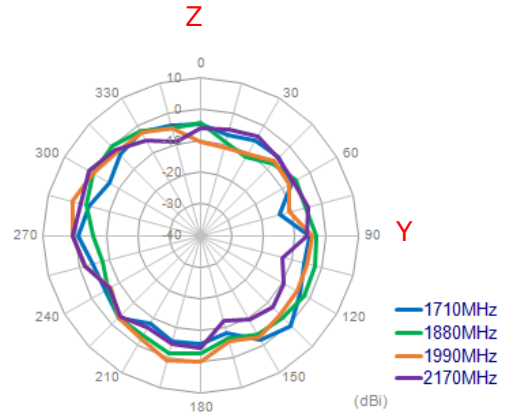
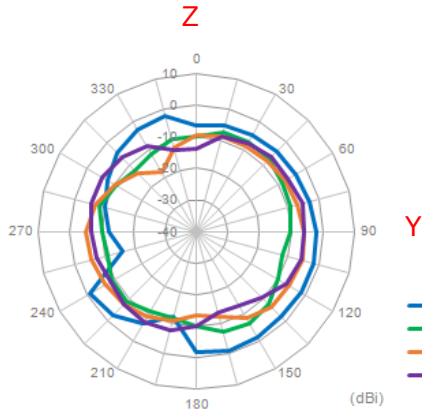

Free Space – LTE MIMO2

X-Y Plane

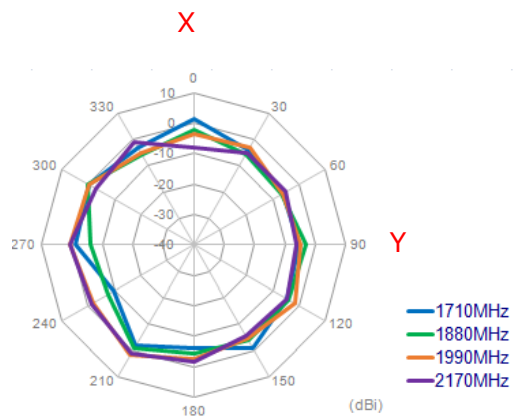
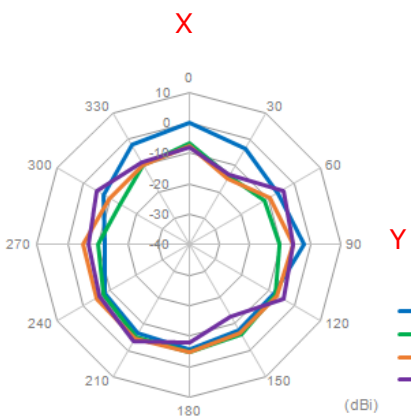

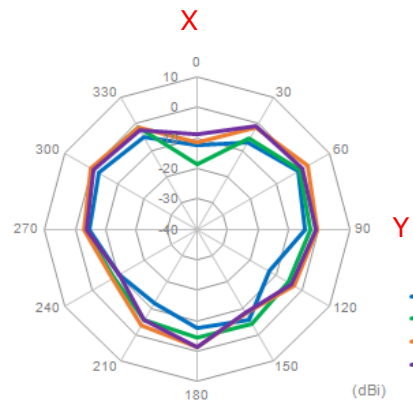
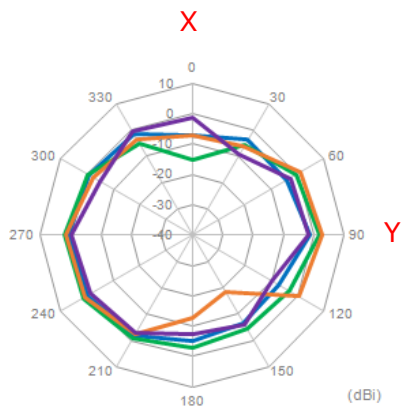

X-Z Plane

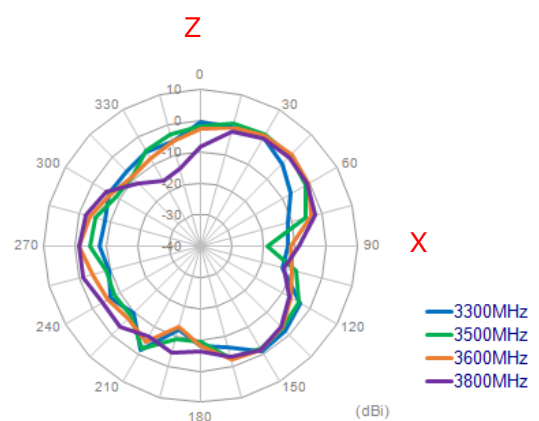
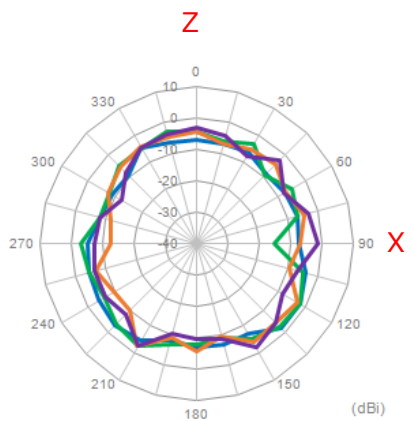
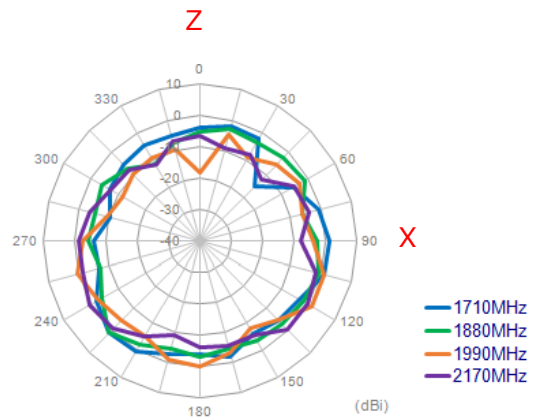
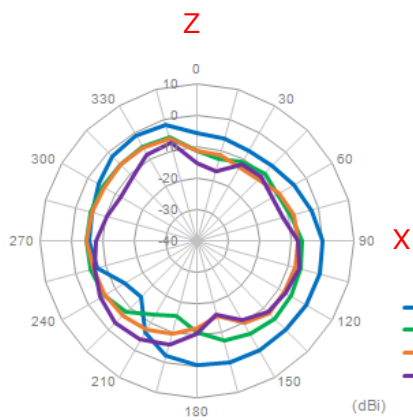

Y-Z Plane

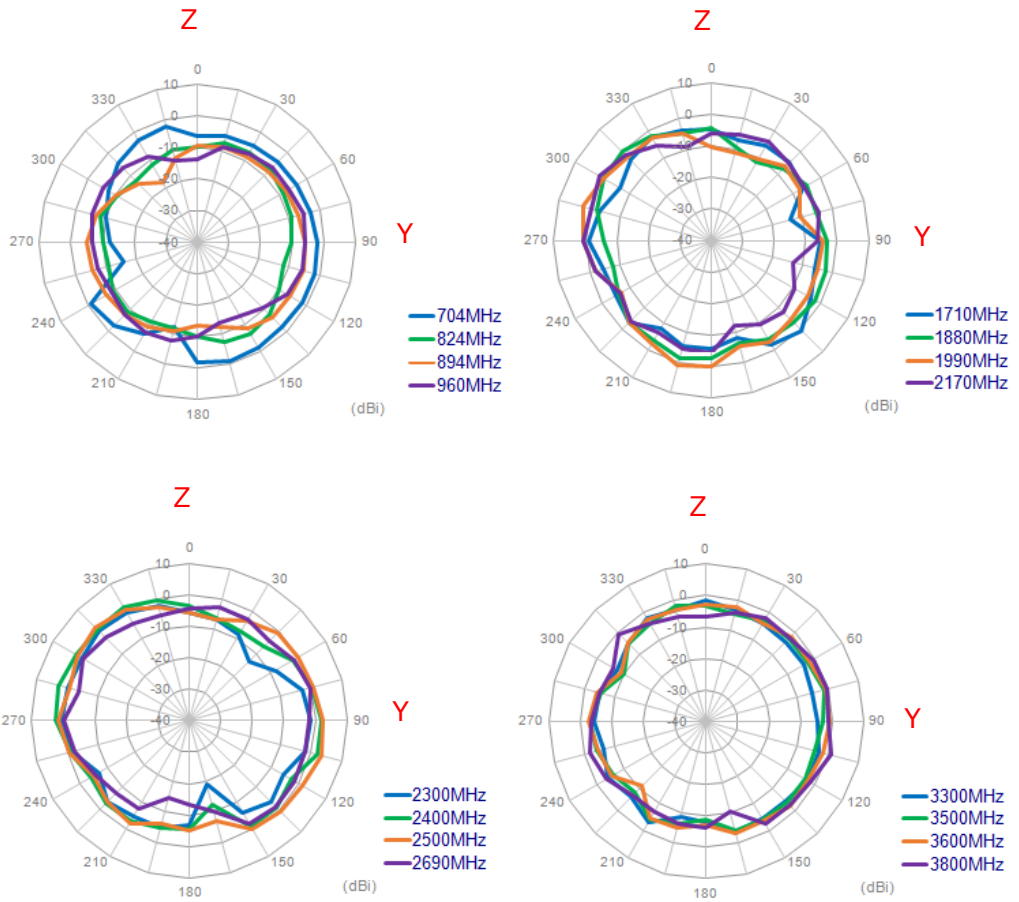

With 30*30cm Ground Plane – LTE MIMO1

X-Y Plane

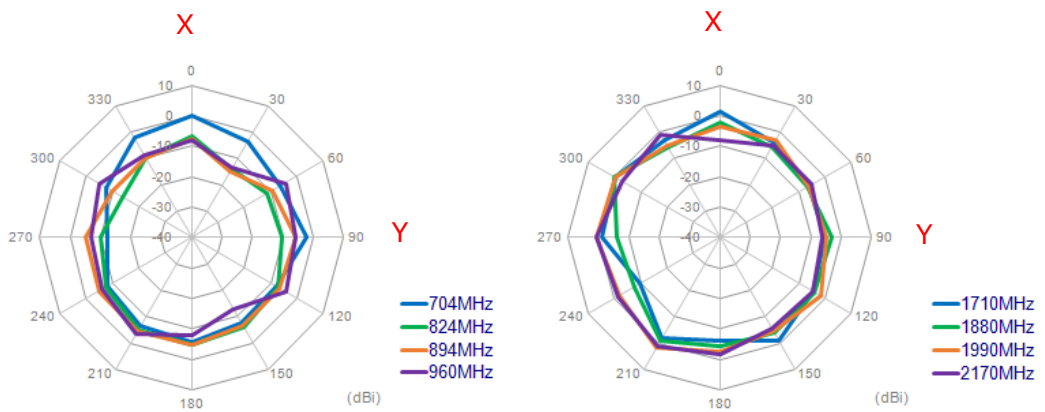

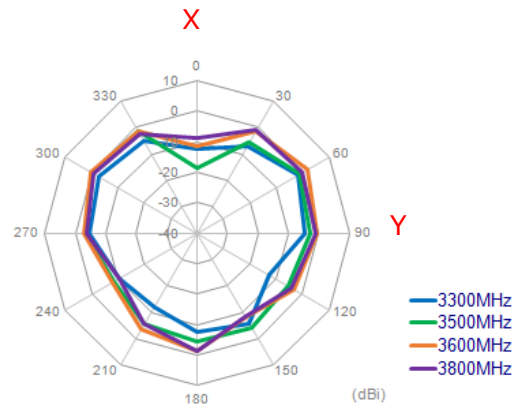
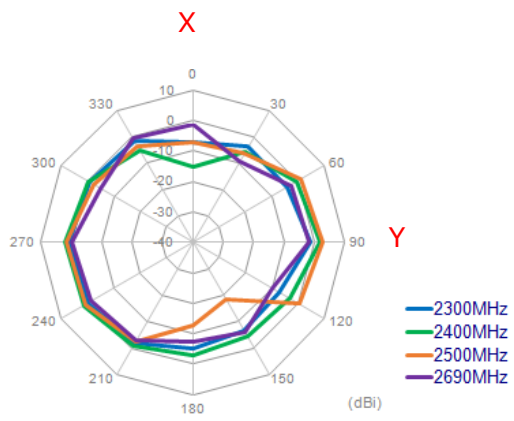

X-Z Plane

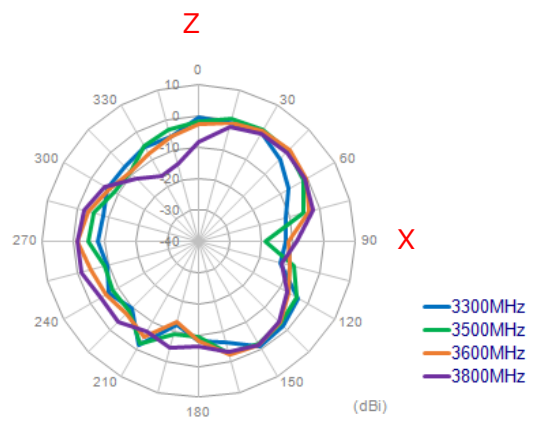
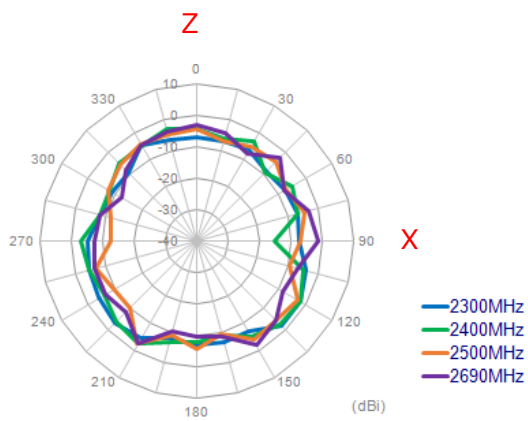
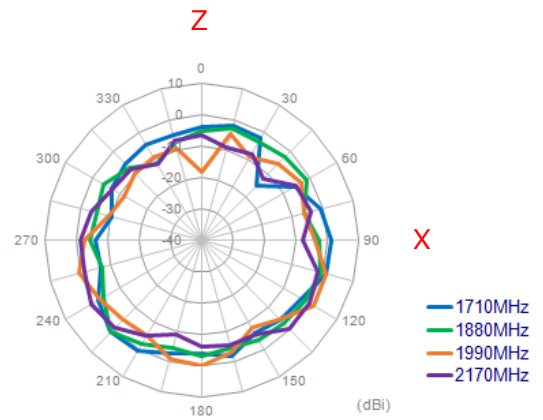
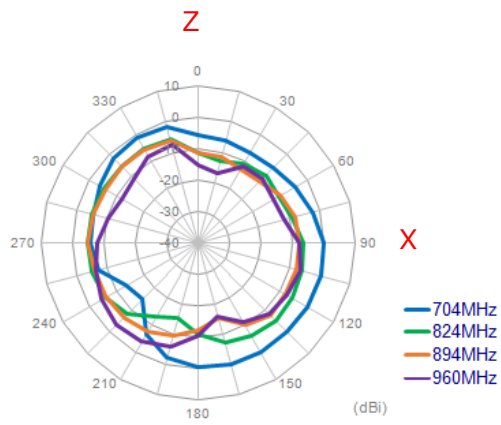

Y-Z Plane

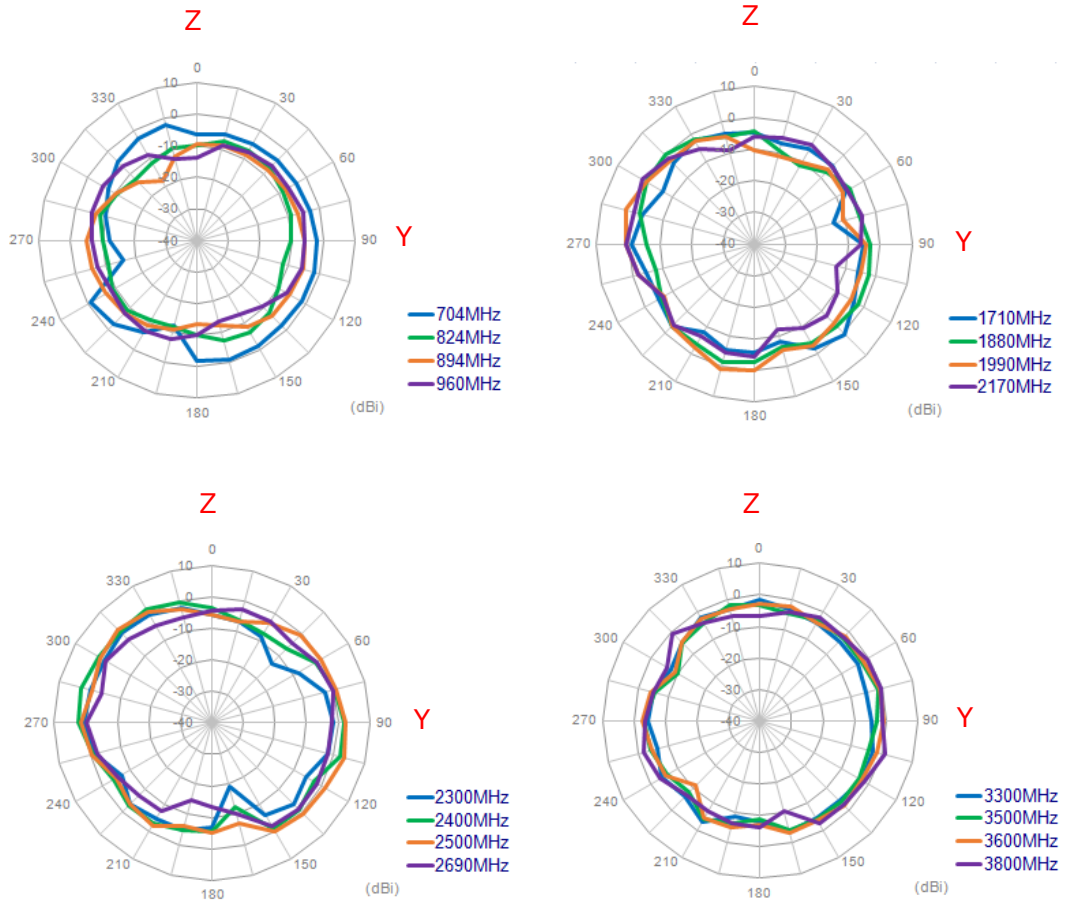

With 30*30cm Ground Plane – LTE MIMO2

X-Y Plane

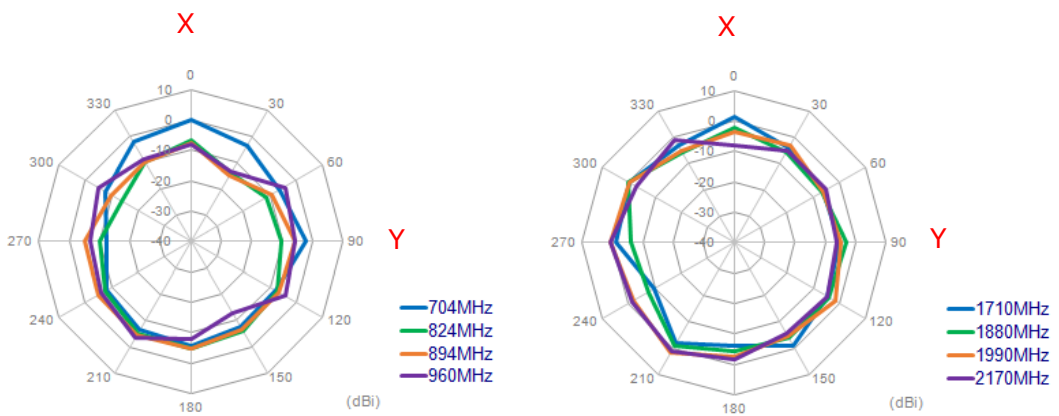

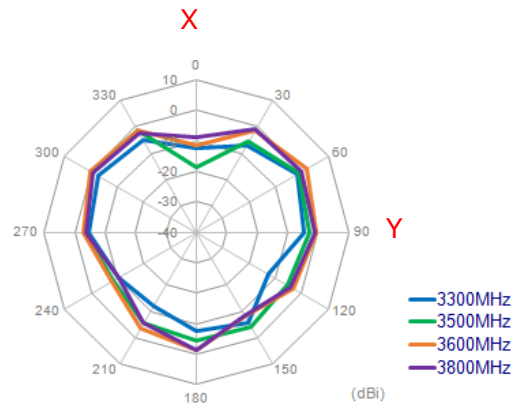
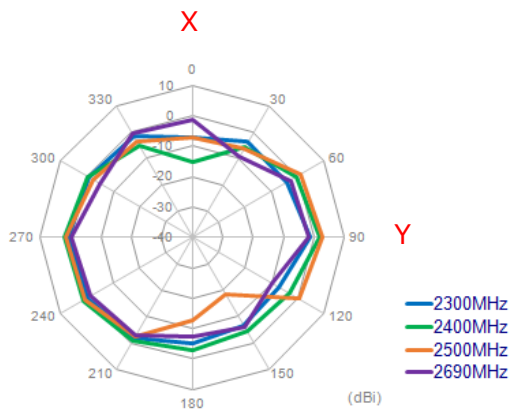

X-Z Plane

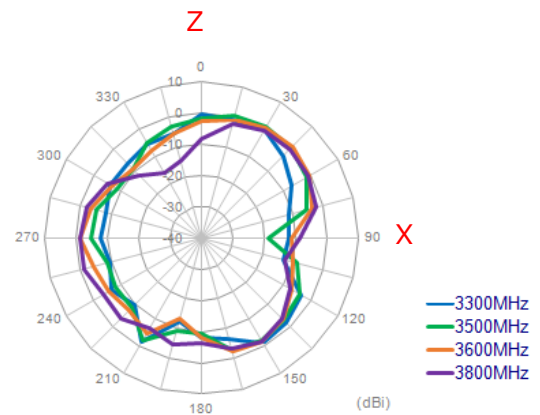
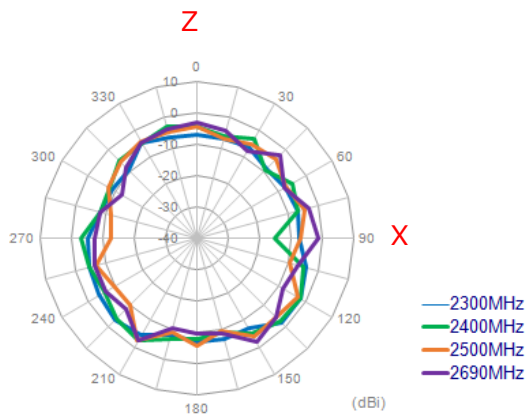
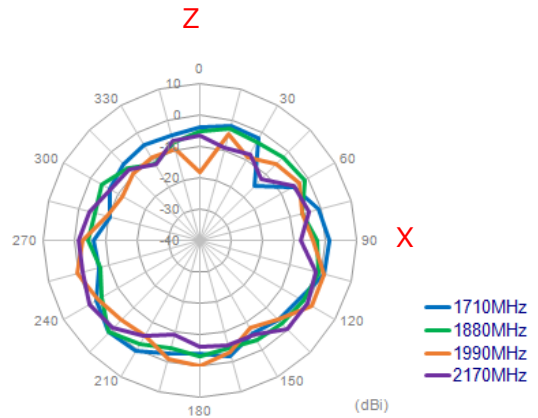
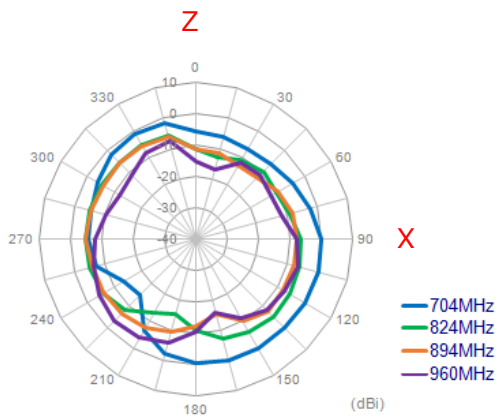

Y-Z Plane

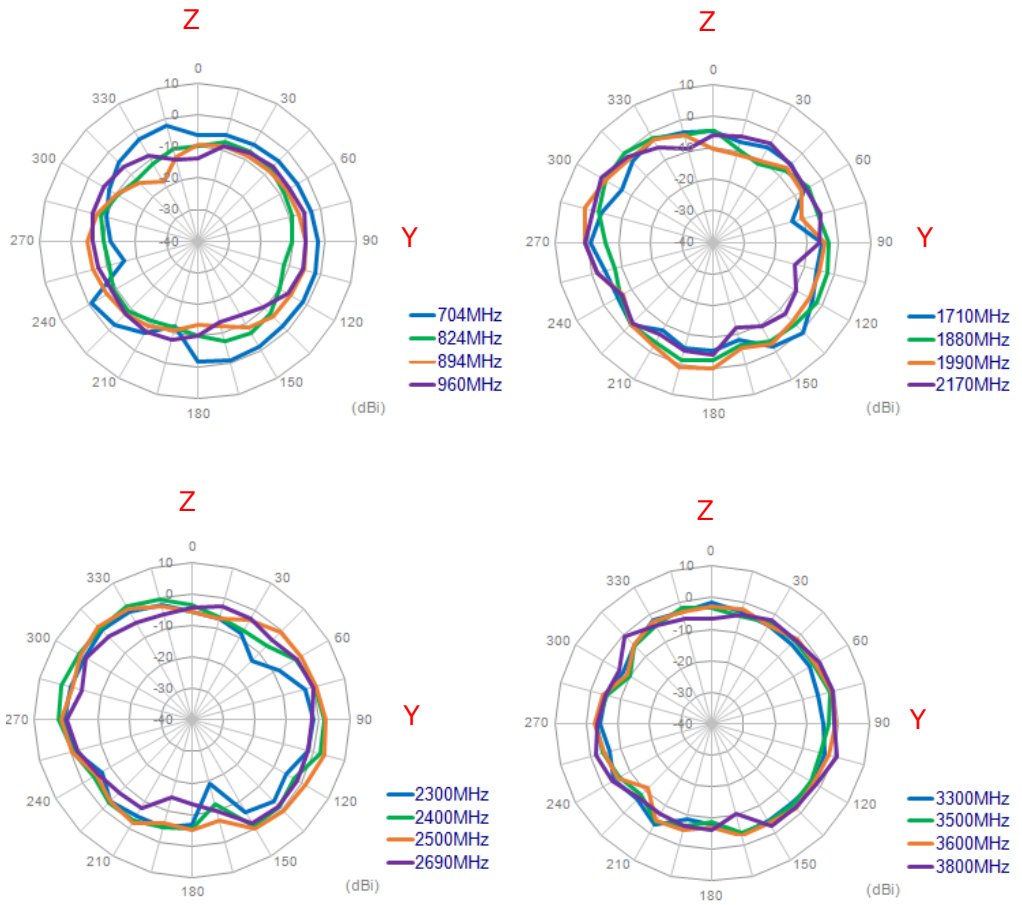

IV. 3D Radiation Pattern:

GNSS

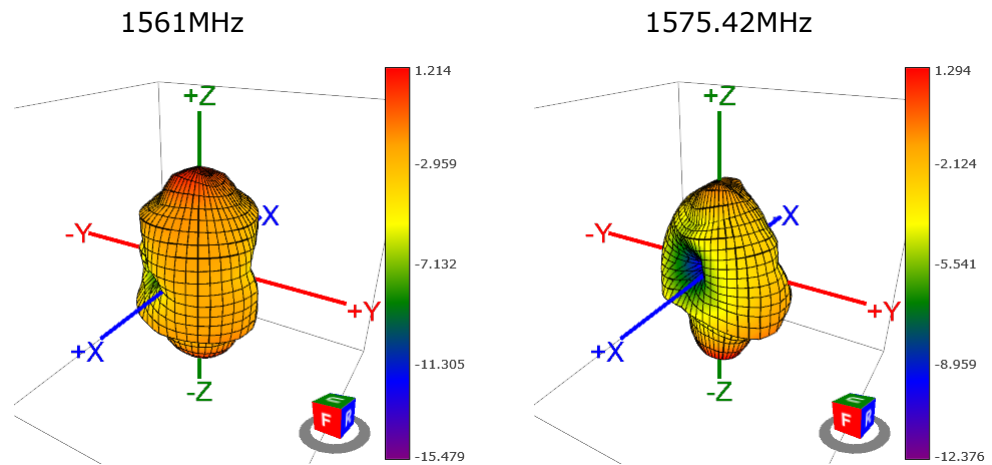

1602MHz

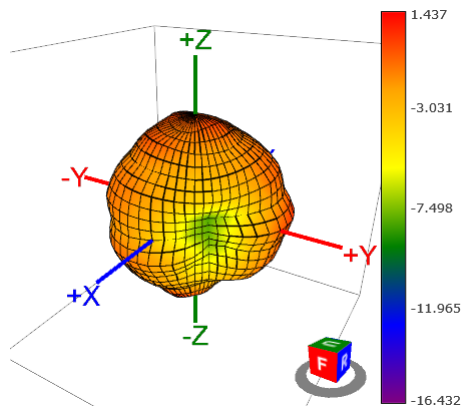

Free Space – LTE MIMO1

704MHz (dBi)

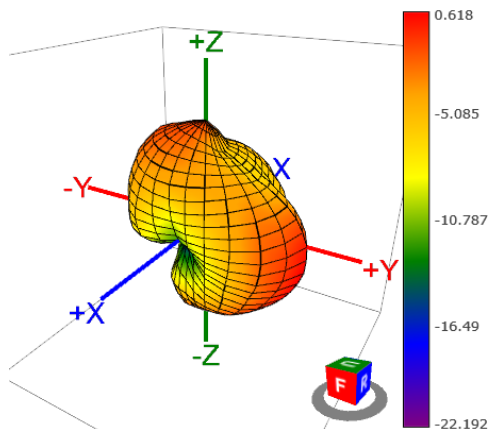

960MHz (dBi)

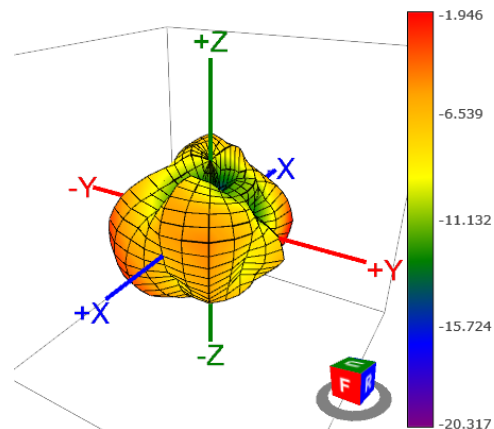

1710MHz (dBi)

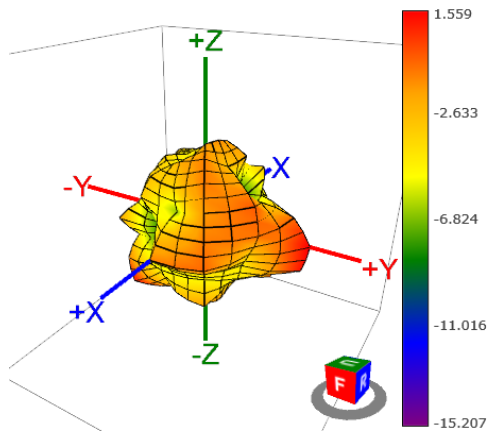

2170MHz (dBi)

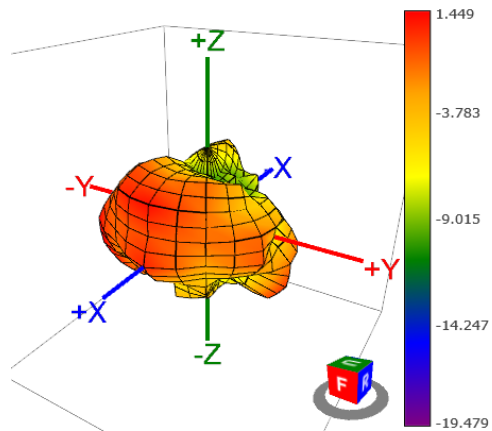

2300MHz (dBi)

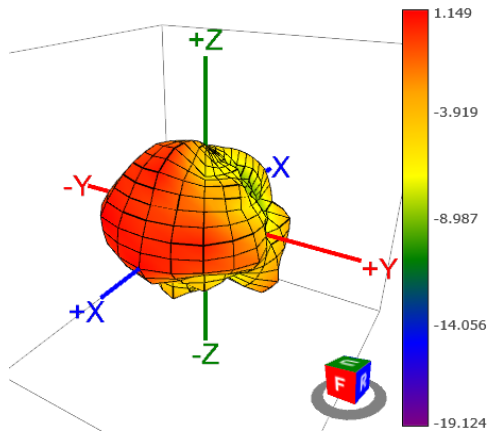

2690MHz (dBi)

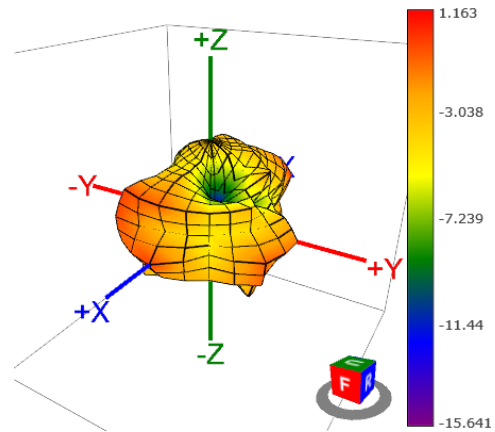

3300MHz (dBi)

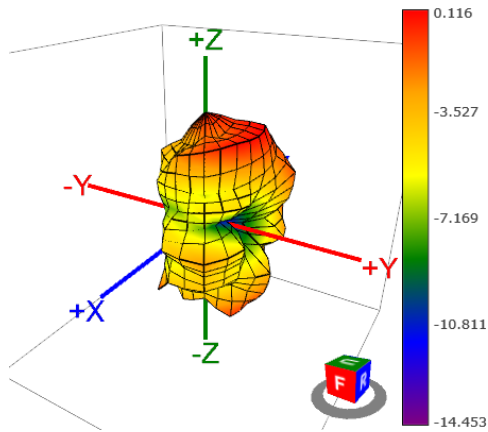

3800MHz (dBi)

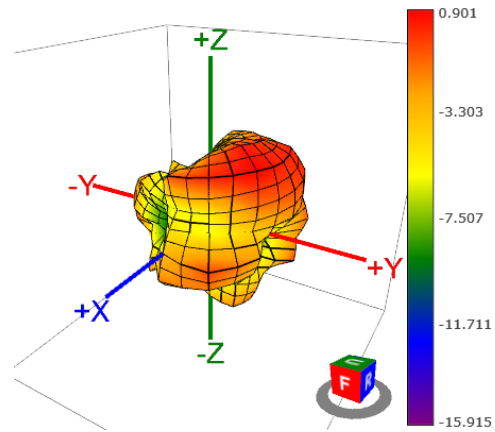

Free Space - LTE MIMO2

704MHz (dBi)

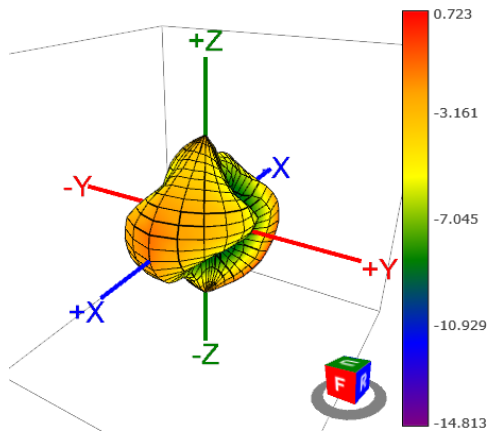

960MHz (dBi)

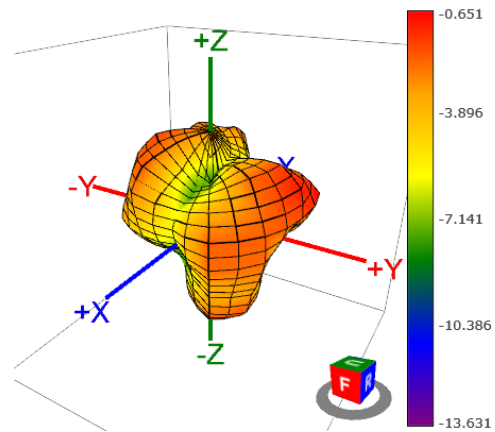

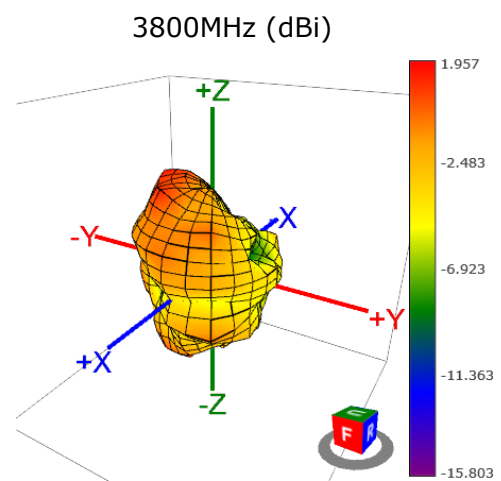
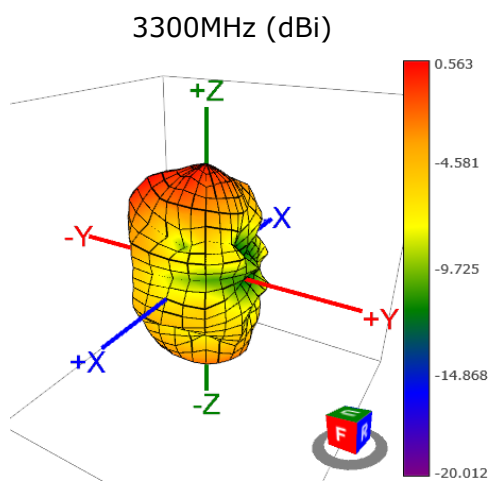
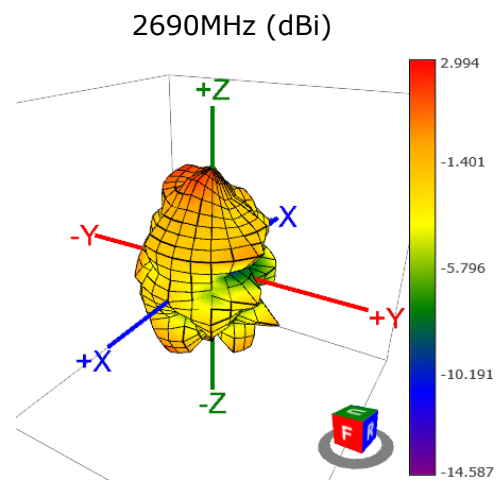
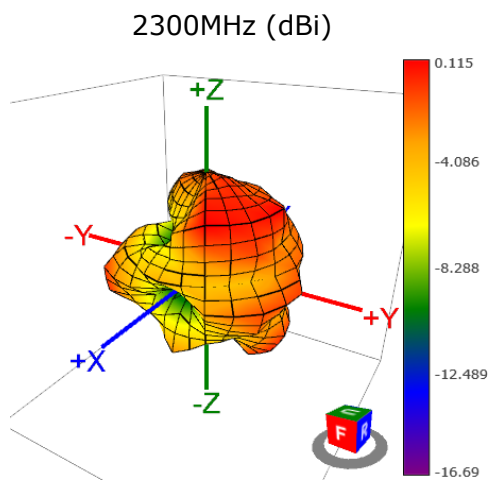
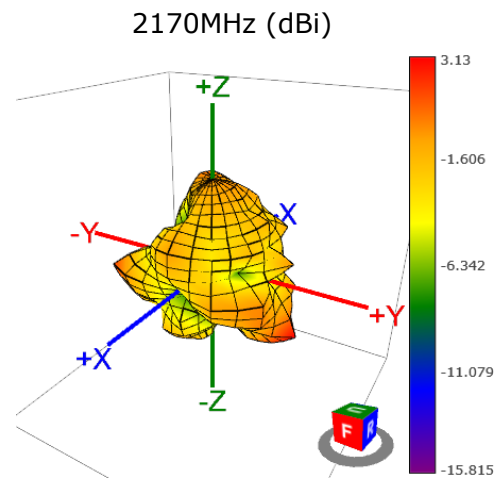
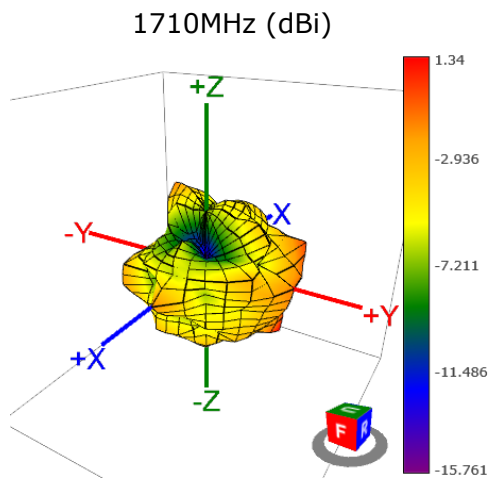

With 30*30cm Ground Plane – LTE MIMO1

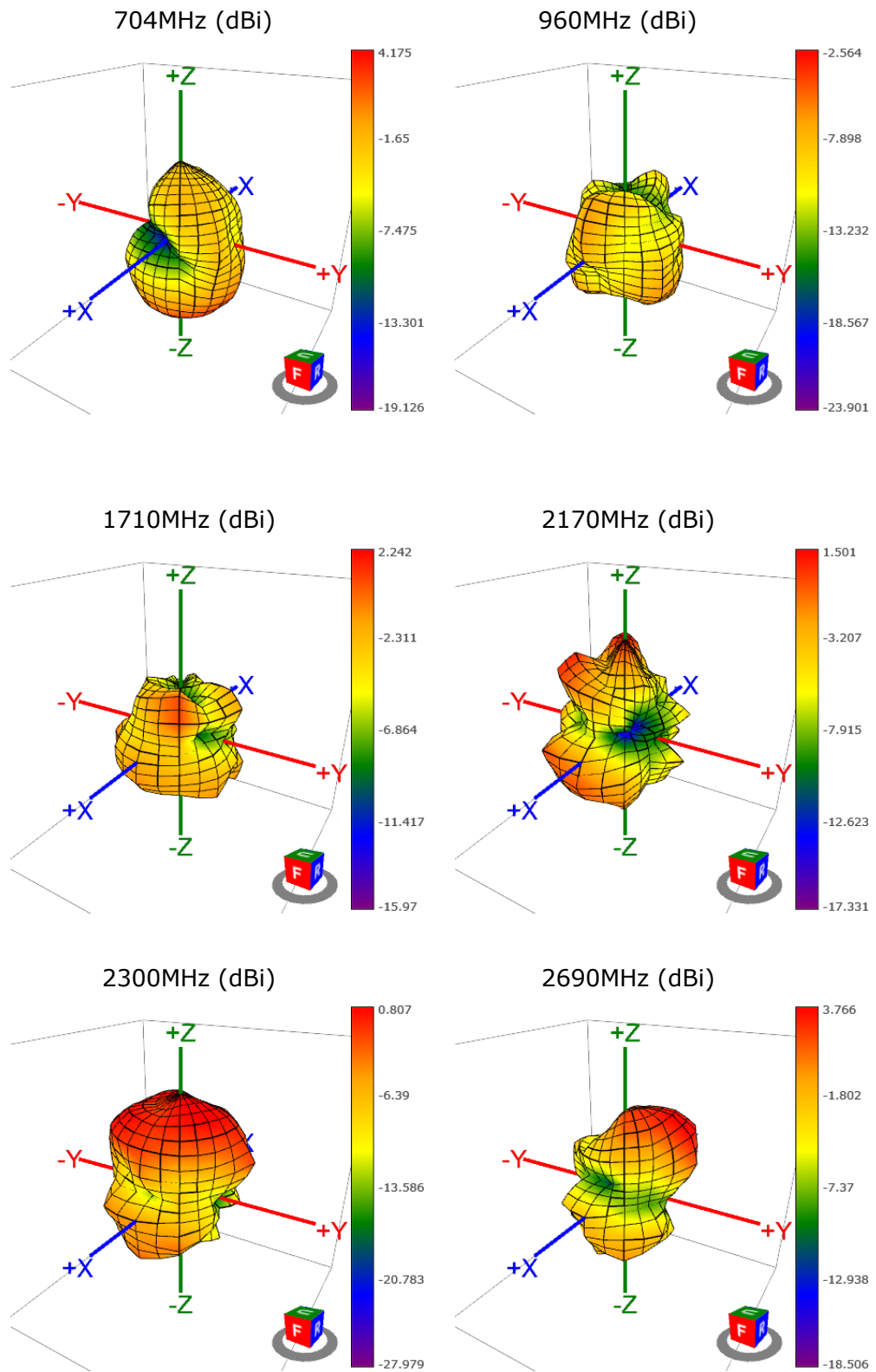

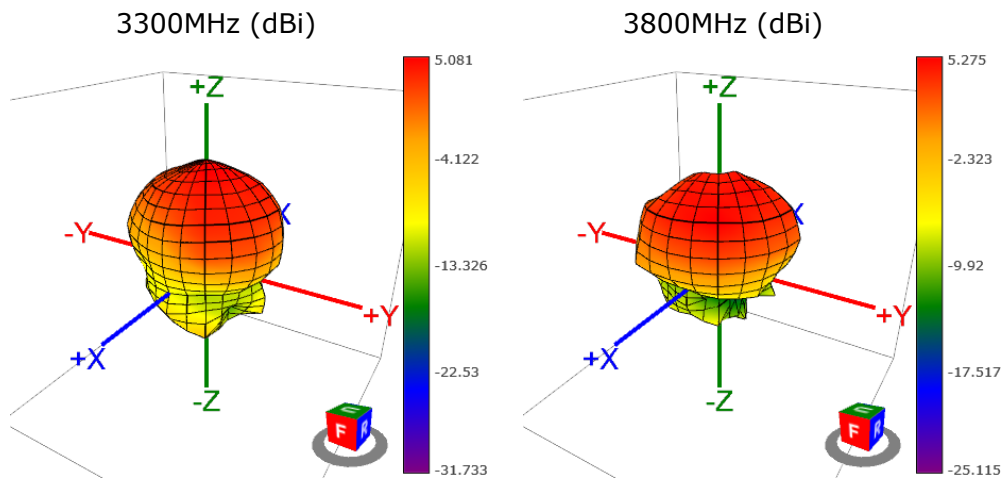

With 30*30cm Ground Plane – LTE MIMO2

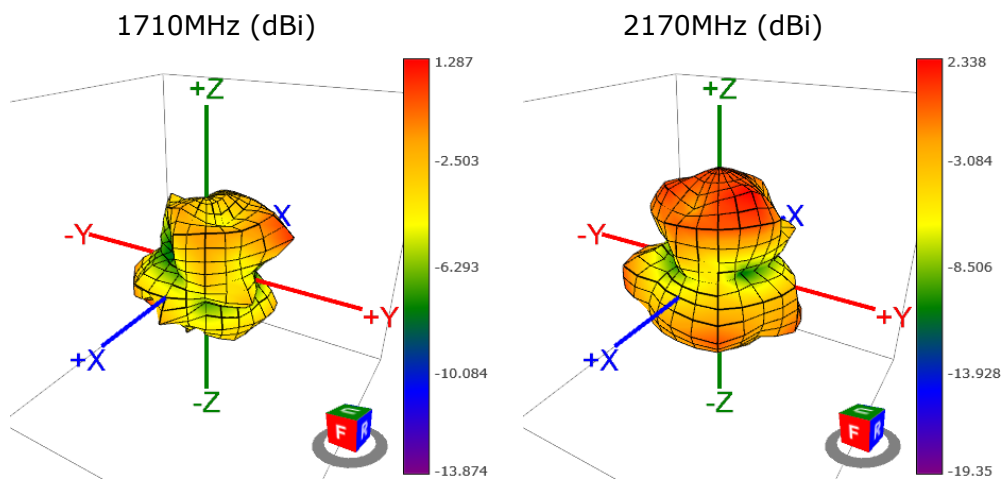
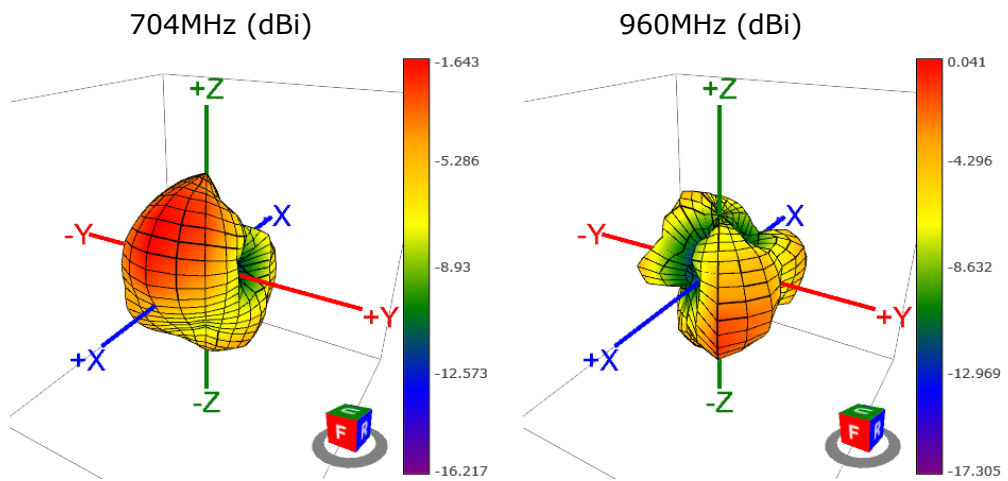

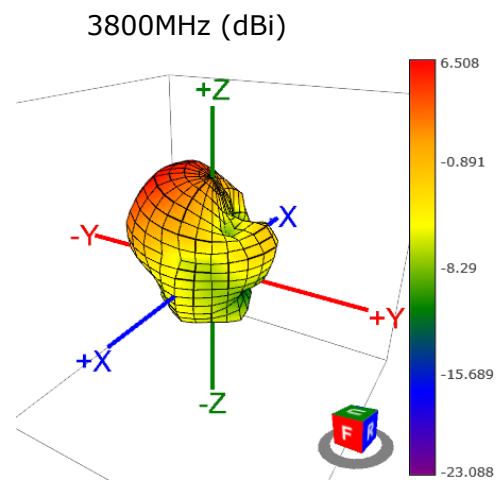
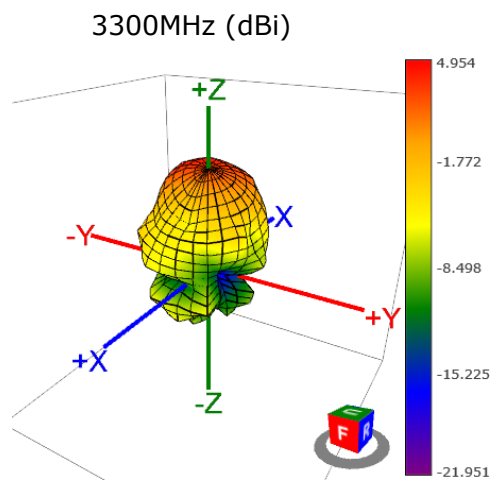
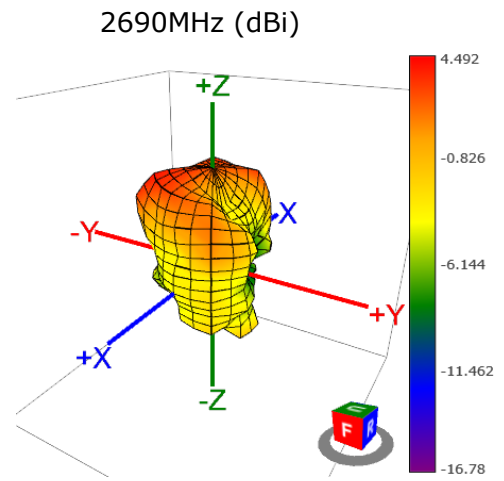
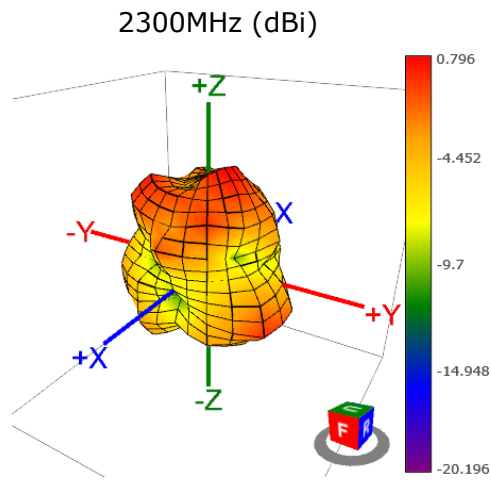

V. Mechanical Drawing (Unit:mm):

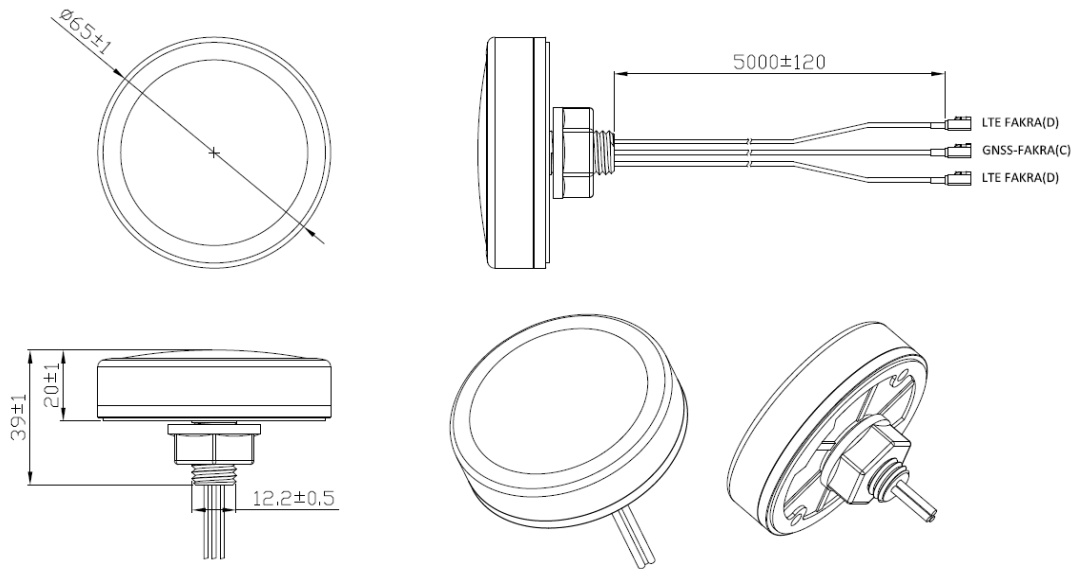

Ordering codes

ADA-X4YZ-C/S/T

- X 0 = Empty 1 = GPS. 2 = GPS/GLONASS. 3 = Full GNSS
Y 6 = WiFi (2.4GHz). 7 = Empty. 8 = 4G/Lte/5G (690-2700MHz)
Z 0 = Empty. 1 = WiFi (2.4GHz). 2 = 4G/Lte/5G (690-2700MHz)

C = screw mount (center bolt).

S = magnetic mount.

T = tape mount

Example

ADA-3482-C means:

1 x Full GNSS + 2 x 4G/Lte/5G + screw mount

Adactus AB, Mariehillsvägen 19, 133 37 Saltsjöbaden, Sweden

Tel: +46 8 608 17 70

E-mail: m2m@adactus.se <http://www.adactus.se/>