GSM STUB ANTENNA

- **GSM Antenna**
- **Dual / Quad band**
- **850/900/1800/1900 MHz**
- **0 dB Gain**
- **SMA connector**

ADA-0086 is a dual band GSM ground plane dependent antenna with a right angel or straight SMA connector.

It is designed to work perfect with all GSM modems, and other products that already have an internal ground plane.

The small PVC covered Stub antenna is easy to place and use even in narrow areas.

ADA-0086Q is the Quad band version of ADA-0086



ADA-0086-L

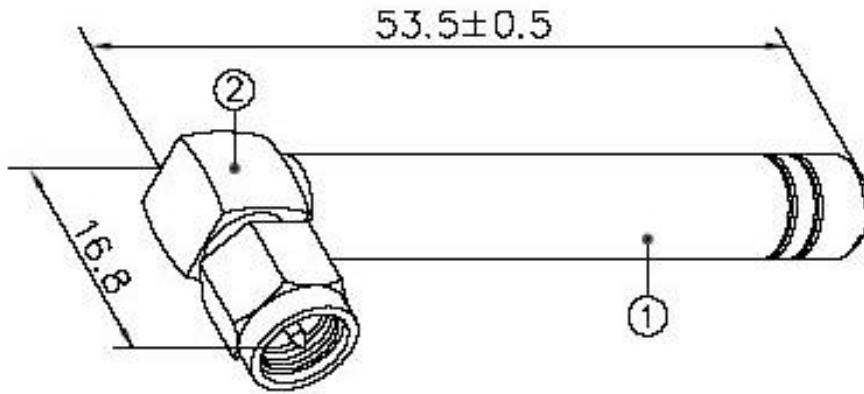

NO.	NAME	MATERIAL	FINISH	Q'TY
1	Ant, shell	PU	Black	1
2	SMA 90° (Male)	Brass	Nickel Plating	1

ADA-0086-I

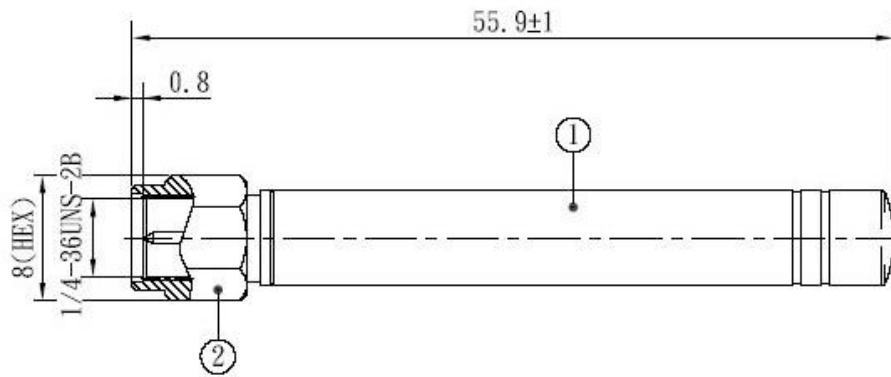

NO.	NAME	MATERIAL	FINISH	Q'TY
1	Core Tube	PVC	Black	1
2	SMA 18° (Male)	Brass	Gilding	1

ADA-0086-I RL

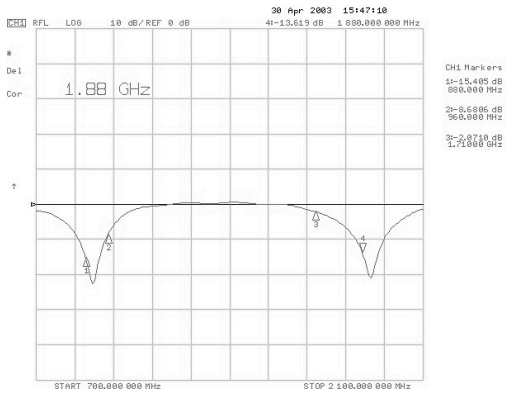

ADA-0086-L RL

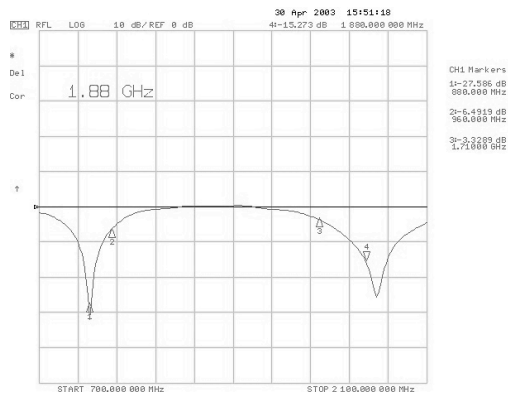

ADA-0086-I SC

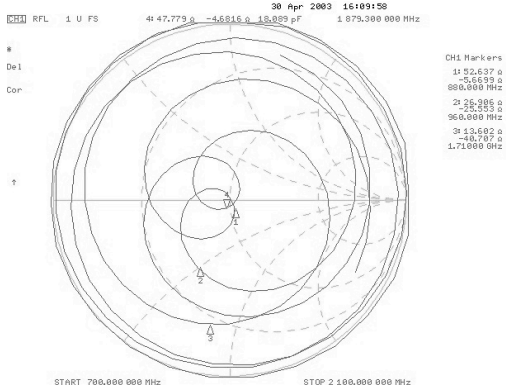

ADA-0086-L SC

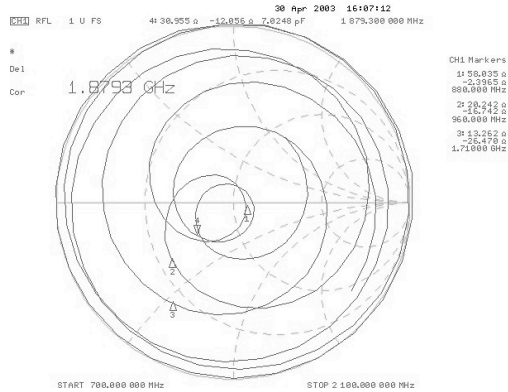

ADA-0086-I VSWR

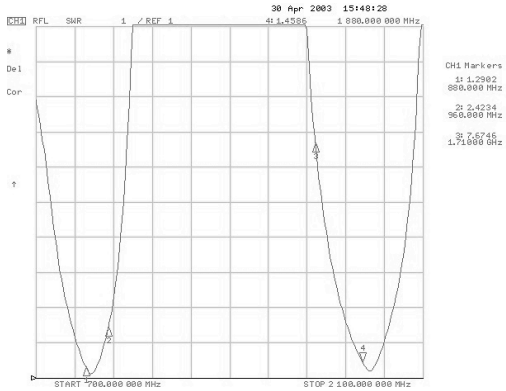

ADA-0086-L VSWR

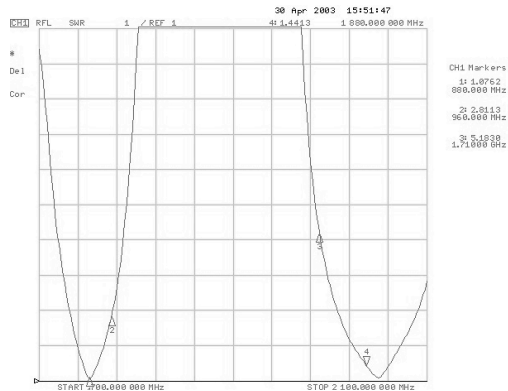

ADA-0086Q-I RL

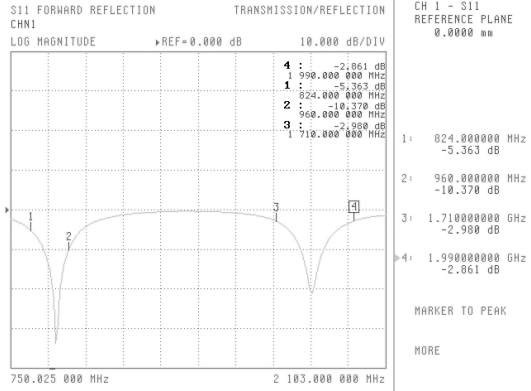

ADA-0086Q-L RL

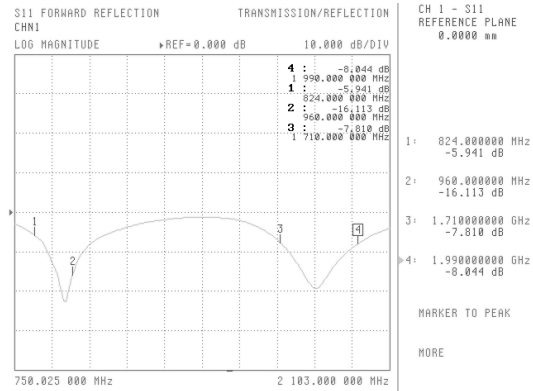

ADA-0086Q-I SC

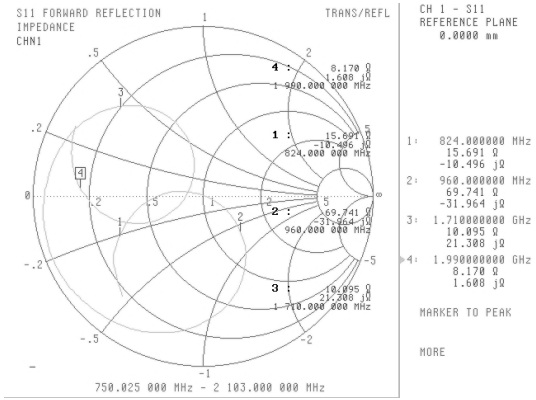

ADA-0086Q-L SC

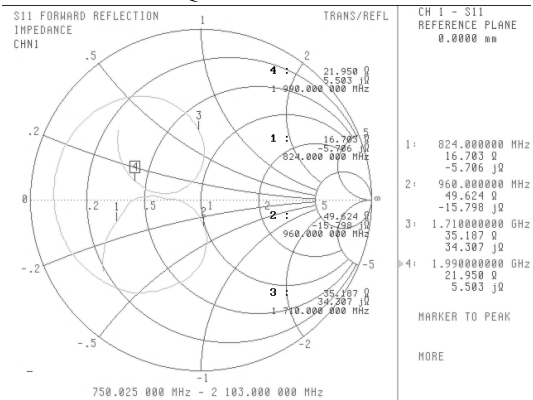

ADA-0086Q-I VSWR

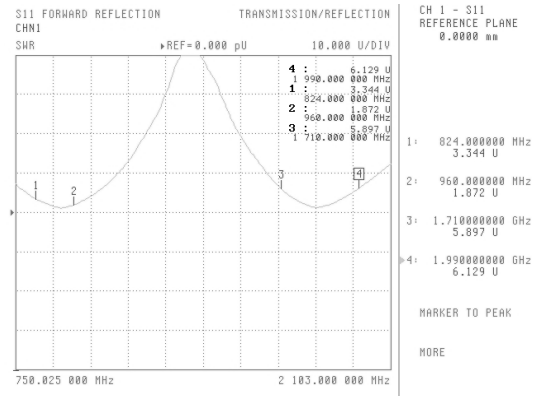

ADA-0086Q-L VSWR

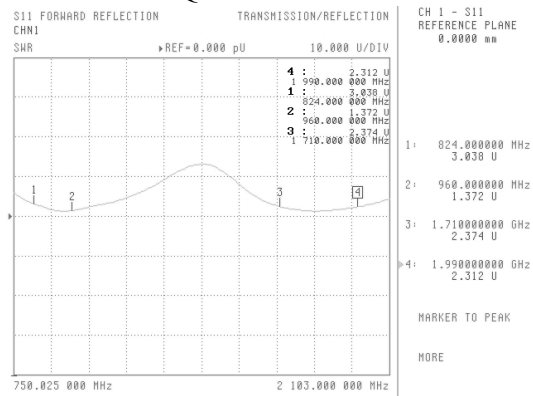

Ordering codes

TYPE	Description	Comment
ADA-0086-L	Right angel SMA connector	GSM dual band antenna
ADA-0086-I	Straight SMA connector	GSM dual band antenna
ADA-0086Q-L	Right angel SMA connector	GSM quad band antenna
ADA-0086Q-I	Straight SMA connector	GSM quad band antenna

For the latest updates, visit our Web site: www.adactus.se

Disclaimer

Information furnished is believed to be accurate and reliable. However, Adactus assumes no responsibility for the consequences of use of such information nor for any infringement of patents or other rights of third parties which may result from its use. Adactus reserves the right to make changes without further notice to any product herein to improve reliability, function or design. Adactus does not assume any liability arising out of the application or use of any product described herein. This publication supersedes and replaces all information previously supplied. Adactus products are not authorized as critical components in life support devices or systems.