

**463

*220

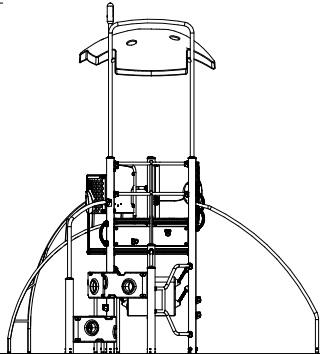

PCE110200
1:100