

**550

*243

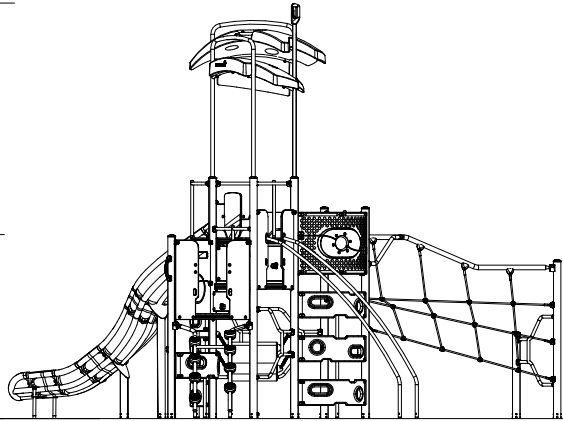

PCE110300

1:100