

**463

*221

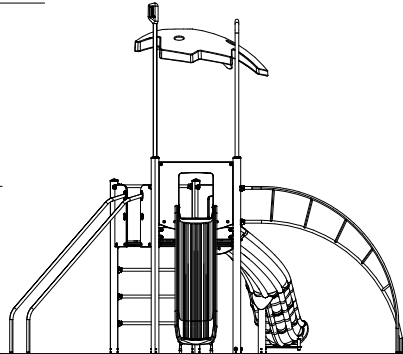

PCE111902
1:100