

**433

*121

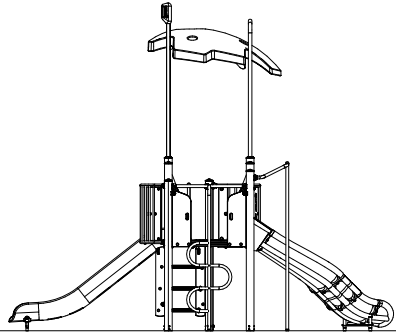

PCE211502
1:100