

**463

*246

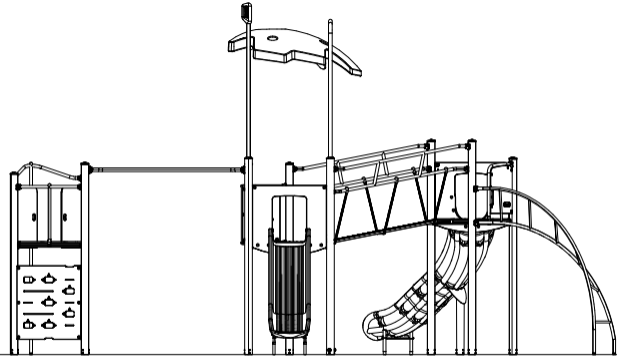

PCE310302
1:100