

# Shelter safety handbook

Some important information  
on how to build safer

© **International Federation of Red Cross  
and Red Crescent Societies, Geneva, 2011**

Copies of all or part of this manual may be made for noncommercial use, providing the source is acknowledged. The IFRC would appreciate all request being directed to the IFRC at [secretariat@ifrc.org](mailto:secretariat@ifrc.org).

The opinions and recommendations expressed in this manual do not necessarily represent the official policy of the IFRC or of individual National Red Cross or Red Crescent Societies. The designations and maps used do not imply the expression of any opinion on the part of the IFRC or National Societies concerning the legal status of a territory or of its authorities. All photos used in this manual are copyright of the IFRC unless otherwise indicated.

Cover illustrations: *V.Verougstraete/IFRC*

**Shelter safety handbook  
305400 04/2011 E 500**

P.O. Box 372  
CH-1211 Geneva 19  
Switzerland  
Tel: +41 22 730 42 22  
Fax: +41 22 733 03 95  
E-mail: [secretariat@ifrc.org](mailto:secretariat@ifrc.org)  
Web site: [www.ifrc.org](http://www.ifrc.org)



# Shelter safety handbook

Some important information  
on how to build safer

*Strategy 2020* voices the collective determination of the IFRC to move forward in tackling the major challenges that confront humanity in the next decade. Informed by the needs and vulnerabilities of the diverse communities with whom we work, as well as the basic rights and freedoms to which all are entitled, this strategy seeks to benefit all who look to Red Cross Red Crescent to help to build a more humane, dignified, and peaceful world.

Over the next ten years, the collective focus of the IFRC will be on achieving the following strategic aims:

1. Save lives, protect livelihoods, and strengthen recovery from disasters and crises
2. Enable healthy and safe living
3. Promote social inclusion and a culture of non-violence and peace



# Table of contents

---

## **Introduction** **4**

---

## **Part 1.** [Risk and shelter safety](#) **5**

---

## **Part 2.** [Hazards and vulnerability of shelter](#) **7**

- 2.1 Earthquakes 7
  - 2.2 Strong winds 8
  - 2.3 Floods 9
  - 2.4 Other hazards 11
- 

## **Part 3.** [General guidance on safe shelters](#) **13**

- 3.1 General principles 13
  - 3.2 Building new shelters 13
  - 3.3 Improving existing shelters 13
  - 3.4 The importance of maintenance, repair and careful modifications 14
- 

## **Part 4.** [Examples of specific measures to ensure safe shelters](#) **15**

- 4.1 Fire 15
  - 4.2 Earthquakes 17
  - 4.3 Strong winds 31
  - 4.4 Floods 43
  - 4.5 Maintenance 52
  - 4.6 Modifications 53
- 

## **Part 5.** [Further information](#) **57**

---

# Introduction

---

This handbook presents some basic information on safe construction practices. Its purpose is to provide guidance on choices regarding settlement planning in risky environments, as well as on the building techniques to improve individual shelters. The contents may be used to develop trainings on participatory shelter risk reduction methods, such as PASSA. This guide is not aimed at construction professionals, although it may serve them to communicate with beneficiaries and volunteers on safety measures. The intended readers are Red Cross Red Crescent volunteers, who are not expected to be experts in shelter construction and safety but should be able to understand the most important technical aspects of shelter safety in the communities in which they work.

A range of hazards and construction types are presented here – fire, floods, strong winds and earthquakes – which typically occur in disaster-prone areas. The illustrations complement the technical recommendations and provide user-friendly support to illustrate the concepts.

# 1. Risk and shelter safety

---

Shelter safety can be understood in relation to risk, which is commonly defined by the following relationship of hazard, vulnerability and capacity:

$$\text{Risk} = \frac{\text{Hazard} \times \text{Vulnerability}}{\text{Capacity}}$$

**Hazard:** *The potential occurrence of a natural phenomenon, in a specific time period and geographical area, which may adversely affect human life, property or activity to the extent of causing a disaster (IFRC VCA Training Guide 2008).* When considering shelter safety, important hazards include earthquakes, strong winds, floods, fire etc.

**Vulnerability:** *The conditions determined by physical, social, economic, environmental or political factors or processes, which increase risk and susceptibility of people to the impact of disasters (IFRC VCA Training Guide 2008).* In terms of shelter safety, vulnerability describes the features of a settlement or of individual shelters that make them more likely to be damaged when a hazard occurs. Vulnerability of shelters is often specific to a certain type of hazard. For example, buildings with thatched roofs are particularly vulnerable to fire, but thatched roofs are less vulnerable than concrete roofs to damage by earthquakes. Other features may increase vulnerability to a range of hazards. For instance, weak connections between walls and foundations or to the ground increase vulnerability to damage by earthquakes, strong winds and floods.

**Capacity:** *The resources of individuals, households, communities, institutions and nations to resist the impact of a hazard (IFRC VCA Training Guide 2008).* Shelter safety is concerned with the physical capacity of homes and communities to resist hazards as well as the social and economic capacity of communities, families and individuals.

---

*Risk: The expected or anticipated loss (in terms of lives, livelihoods, property and/or economic activity) due to the impact of a given hazard on a given element at risk over a specific period of time. Risk is defined differently by people in different situations. The concepts of vulnerability, hazard and risk are dynamically related (IFRC VCA Training Guide 2008).*

Risk may be reduced by means of the following strategies:

- ↳ Preventing or lessening the likelihood of hazards – e.g., locating settlements away from coastal areas where tidal surges occur
- ↳ Reducing shelter vulnerability and strengthening capacity – e.g., by reinforcing the walls of houses in earthquake zones
- ↳ Building and maintaining preparedness – e.g., by building a cyclone shelter and having sandbags ready to protect houses from flooding caused by cyclones.

In most communities it will not be possible to prevent hazards significantly. In these cases, the most feasible strategies are to reduce shelter vulnerability and to be prepared for hazards in case they occur.

For more information on risk, vulnerability and capacity, see the IFRC VCA Training Guide (2008) pages 24-26.

## 2. Hazards and vulnerability of shelter

---

### 2.1 Earthquakes

#### What causes earthquakes?

Earthquakes are caused by movements deep in the earth that cause the ground to shake at the surface.

#### What damage do earthquakes do?

*Forces created by earthquakes:* powerful side-to-side (or up and down) shaking of the ground that cannot be controlled in any way. Earthquakes under the sea may cause tsunamis that affect coastal areas.

*Damage done by earthquakes:* damage and collapse of buildings and other structures. Earthquakes may also cause landslides and rockfalls.

#### What increases vulnerability to earthquakes?

The most vulnerable buildings are those that are not strong, those that are tall and those that have heavy roofs, unless they are designed and constructed to be earthquake resistant. Badly designed or poorly constructed reinforced concrete structures are also vulnerable and are very dangerous when they collapse because they are so heavy. Buildings on loose soil or unstable slopes are at risk because the ground may give way and cause them to collapse or fall over.

## 2.2 Strong winds

### **What causes strong winds?**

*Cyclones/hurricanes/typhoons* are caused by very large low-pressure weather systems that are created over tropical oceans and may move inland. Wind speed may reach 300 kilometres per hour, causing damage over large areas.

*Tornadoes* are also created by low-pressure systems, but usually form over land and are much smaller and restricted to specific parts of the world. They can be very powerful, with strong twisting winds at the centre.

*Storms and gales* are caused by the interaction of cold and warm air masses that can occur in almost any coastal area of the world. Winds may exceed 90 kilometres per hour and may continue for several days.

The frequency and intensity of strong winds is increasing as part of a pattern of climate change.

### **What damage do strong winds do?**

*Forces created by strong winds:* pressure and suction that push and pull against buildings and other objects.

*Damage done by strong winds:* both pressure and suction forces may cause parts of buildings to blow off and cause heavy elements such as chimneys to fall on to the rest of the building creating further damage. Suction forces, which can be much stronger than pressure forces, may suck out windows and pull off roofs. In some cases buildings may collapse completely, particularly when the winds last several hours.

Cyclonic winds and storms are associated with heavy rains that can enter houses through damaged roofs and walls. Water

from heavy rain can erode the foundations of buildings, causing subsidence and collapse.

Strong winds can lift loose objects and throw them against buildings.

### **What increases vulnerability to strong winds?**

Buildings that are located in unsheltered sites and those close to large and old trees are especially vulnerable to strong winds. Lightweight buildings are vulnerable, unless they are very well constructed and anchored to the ground. Particularly vulnerable are temporary and informal shelters made from plastic sheeting or recycled materials.

## **2.3 Floods**

### **What causes floods?**

*Cyclones/hurricanes/typhoons* are accompanied by heavy rains that are released when the storm reaches land causing extreme flooding.

*Coastal flooding* caused by cyclones/hurricanes/typhoons which create higher-than-usual sea levels, by tidal surges and less commonly by tsunamis.

*River flooding* caused by rivers that burst their banks as a result of extremely high rainfall or melting snow or by the controlled release of water from dams. River flooding is more likely with big rivers in flat valleys, where large areas of land may be covered by rising water.

*Flash flooding* caused by very sudden releases of water during very intense rainfall, particularly where river catchments have a low capacity to ease surface flow, or as a result of dam failure or uncontrolled releases of water. Flash flooding is a hazard in

steep valleys in high or hilly areas. It creates localized damage by fast-flowing water and may lead to landslides.

*Urban flooding* results from intense rainfall in urban areas where the water cannot drain into the paved ground and where natural and man-made drainage systems are insufficient or are blocked or broken.

The frequency of severe flooding is increasing as sea levels rise and as high-intensity rainfall and strong winds become more frequent with climate change.

### **What damage do floods do?**

*Forces created by floods:* strong sideways pressure on buildings. The deeper the water and the faster it moves, the greater the pressures exerted. Moving water creates local areas of turbulence that change the direction of pressure.

*Damage done by floods:* immediate damage is done by the force of the moving water that can push down buildings and carry people and their property away. Debris in the water can also cause damage. Pollutants such as mud, chemicals and sewage can destroy property inside buildings. Water may weaken building foundations and walls, and make the ground unstable, so this can lead to landslides or ground failure.

Large volumes of moving water can erode the landscape, create landslides and cause the collapse of buildings and physical infrastructure such as roads and bridges. When the water moves away the mud and debris remain, contaminating houses, buildings and the environment.

### **What increases vulnerability to floods?**

The location of the shelter in flood plains or in the likely path of flash floods is the most important aspect of exposure to flooding.

Deforestation and land clearance may make settlements more exposed to floods. Buildings made of earth or of masonry with water-soluble mortar are highly vulnerable, as well as those with inadequate foundations or walls that are unable to resist sideways pressure.

## 2.4 Other hazards

### Fire

In urban areas, the greatest danger from fires is caused by activities in the settlement itself. Once established, the fires may spread to wide areas, particularly in high-density settlements and those where combustible materials are used for buildings.

In rural areas, the cause may be forest fires or bush fires that start outside the settlement. Communities most at risk are those that are not surrounded by sufficient firebreaks and where shelters are built of thatch and other combustible materials.

Fires are usually caused by activities in the household such as cooking. Shelters built of combustible materials are most at risk (particularly thatched roofs and timber-framed structures).

### Landslides

Land instability involves sloping soil or rocks collapsing suddenly or over time. There are several types of land instability, including landslides, rockfalls and subsidence. These are often triggered by earthquakes, heavy rains and flooding. The main causes of damage to shelter are crushing by rocks, mud or debris, and collapse due to sudden or gradual movement of the ground under the building.



## 3. General guidance on safe shelters

---

### 3.1 General principles

Whatever the hazard of concern, attention must be given to the following aspects of shelter safety:

- The location and layout of the settlement as a whole
- The siting and orientation of individual shelters
- The design of shelters (size, height, shape etc.)
- The choice of construction materials
- The quality of construction, and the way the materials are put together.

### 3.2 Building new shelters

The likely hazards that may need to be avoided or resisted should be considered at the stage of designing a shelter and choosing its site. Where a collection of new buildings or the development of a new residential site are concerned, the analysis of hazards and design for risk reduction should review the selection, layout and infrastructure of the whole settlement. National building codes may identify regions that are prone to particular hazards and specify safety features that should apply. Traditional building techniques may also offer appropriate measures for dealing with local hazards. The PASSA process may identify additional or optional features and techniques applicable at community level.

### 3.3 Improving existing shelters

For the majority of communities, increasing shelter safety depends on improving their existing shelter. Most of the examples of simple improvements to make safe shelter provided below are possible to implement on existing buildings, either as a specific measure or at a time when major repairs or modifications are being carried out. For example, if a roof is replaced on a masonry

---

house, this would provide an opportunity to add a ring beam before putting on the new roof, and ensuring that the new roof is well fixed on to the ring beam.

### **3.4 The importance of maintenance, repair and careful modifications**

All buildings deteriorate over time, and it is essential that they are regularly inspected and repaired if needed so that their safety is maintained. Any modifications should be carefully considered and carried out in such a way as to increase safety rather than decrease it.

## 4. Examples of specific measures to ensure safe shelters

---

### 4.1 Fire

#### Siting and settlement

Choose a site that is protected from, or distant from, fire hazards such as industrial fires and bush fires.



Allow for space between shelters or rows/blocks of shelters whilst taking into account the direction of any prevailing wind.



Allow space between individual shelters and any local fire hazard such as a craft workshop, kitchen etc.



### Construction

Build the shelter with non-combustible materials if possible. Protect combustible materials with fire retardant or by covering with non-flammable material e.g., a thatched roof will be more vulnerable to fire than a roof covered with corrugated iron sheets.



### Preparedness

- ↘ Set up a warning system at community level to alert householders and firefighters.
- ↘ Consider providing water points at strategic places.
- ↘ Have firefighting equipment ready at household and community level and practise its use regularly.

## 4.2 Earthquakes

### Siting and settlement

The site occupied by a building and by a community is very important for reducing vulnerability to damage by earthquakes.

The site should not be exposed to landslides and rockfalls that may occur during or after an earthquake. The acceptable degree of slope will vary according to ground conditions: the greater the slope, the more important the stability of the ground.



The site should be located on stable ground; avoid constructing on filled ground.

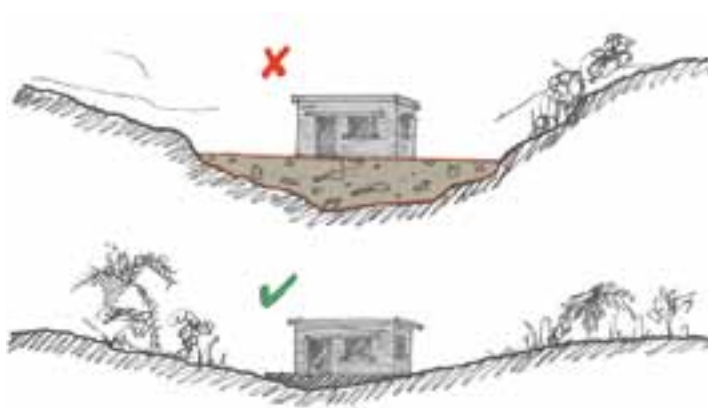

A safe distance should be kept from retaining walls, uphill and downhill.

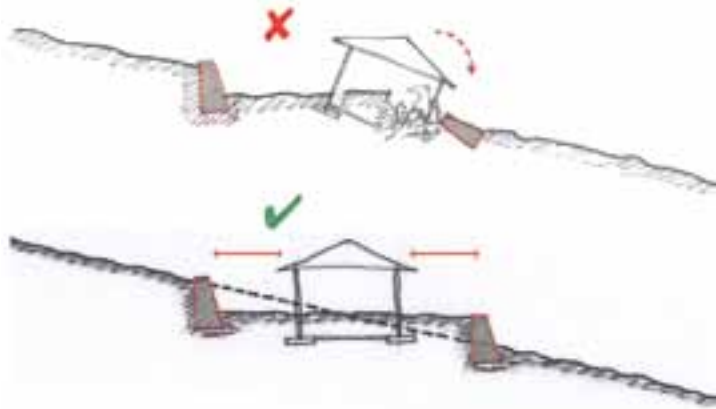

Buildings should be far enough apart so that if one collapses it does not damage the neighbouring ones.

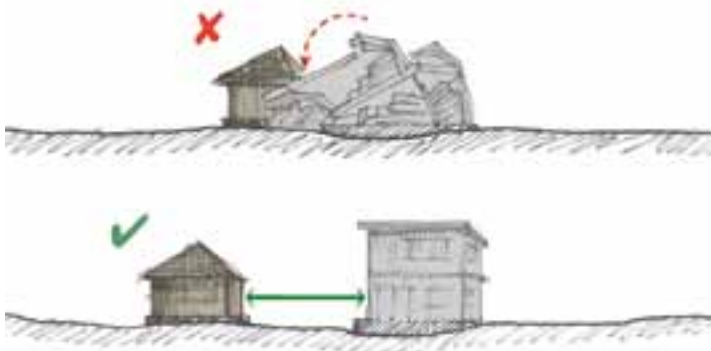

Adjacent buildings should generally be independent of each other.



### Construction

Strong construction is the best protection against earthquakes. Masonry buildings (brick, stone, rammed earth etc.) require strengthening to stop them falling apart when shaken. Lightweight buildings with timber frames hold together well and cause less damage if they collapse. Below are some measures to reduce the vulnerability of shelter to earthquakes.

Avoid constructing on liquefiable soils or soft clay, or in swampy areas. Build the shelter on foundations or piling that rest on stable ground.

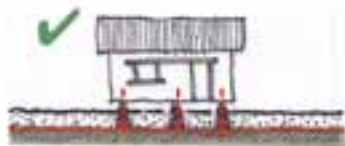

### Foundations

The choice of construction materials will influence the structural resistance of a building. Use good-quality materials for bases and foundation walls.

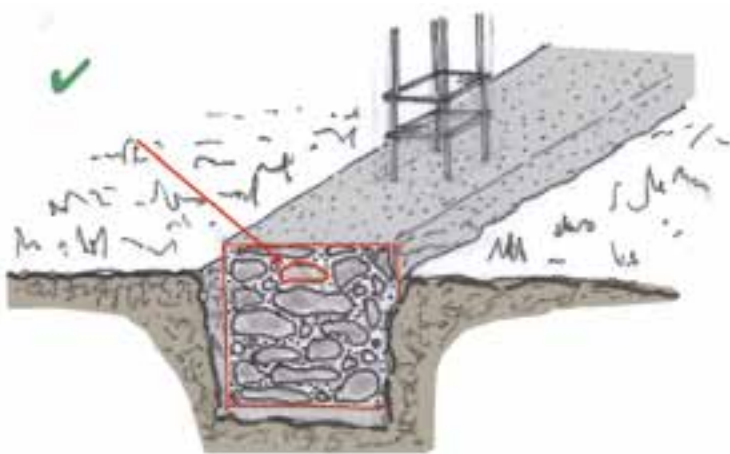

To obtain strong concrete, clean sand and gravel of good quality must be chosen. Coral sand should never be used in any construction: it will make the concrete disintegrate and the reinforcement steel bars will corrode. Coarse sand should be sieved to remove stones, fine particles and dust. If the sand comes from a dirty or seawater source, it must be washed. Good sand is all of about the same coarse texture and does not have stones or dust in it.



Rounded river rocks should not be used for foundations unless they are broken. Use crushed rock laid on solid ground and well cemented.



The water used for concrete must be free of salt, algae or any other vegetable matter.



### WALLS AND OPENINGS

#### General

Choose a strong, resistant building form: simple, symmetrical and compact, with mutual support between walls.



When parts of the building have different heights, they should be structurally disconnected from each other.

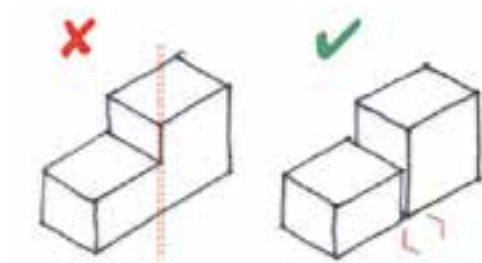

### *Masonry buildings*

Use good-quality materials (masonry and mortar materials) for walls. Use clean sand for the mortar.

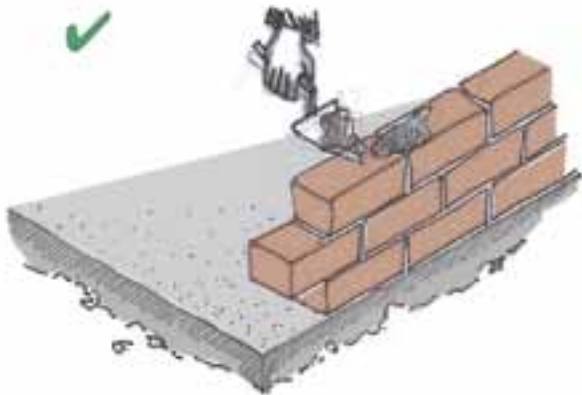

Provide sufficient thickness and strong bonding for masonry walls: the courses of masonry should be well bonded (overlapped) to avoid vertical cracks, and wall junctions should be well bonded with a 10-millimetre mortar joint to hold them together. The same recommendation applies to infill masonry with cast-concrete post, as illustrated below.

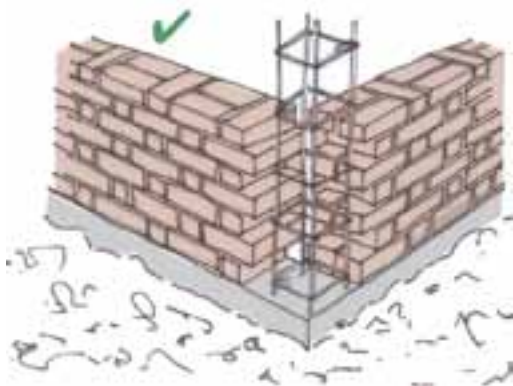

Position windows and doors away from corners and make sure that openings in the structure are well formed.

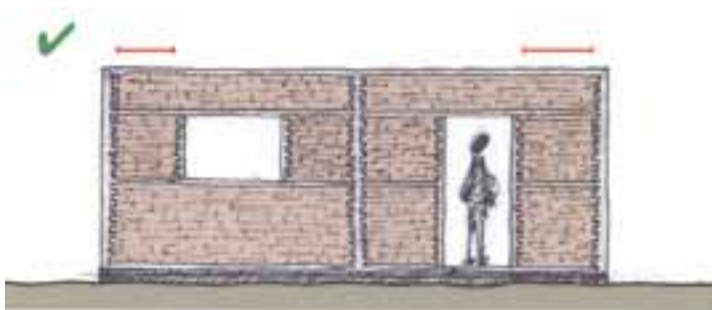

Seismic bands should be placed at lintel level, even if there is no window or door.



Whenever possible, create a system of horizontal reinforcement to tie the bottom of the wall to the foundation and the top of the walls to upper floors or concrete roofs. This creates a connected and continuous rigid structure and is probably the most important measure for masonry buildings.

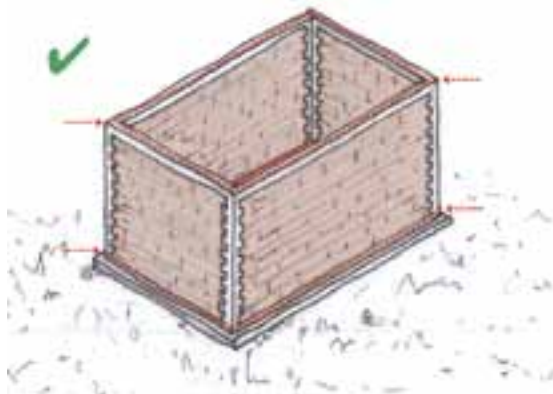

The construction should have a reinforced plinth beam to ensure a proper connection between the foundations and the masonry walls.

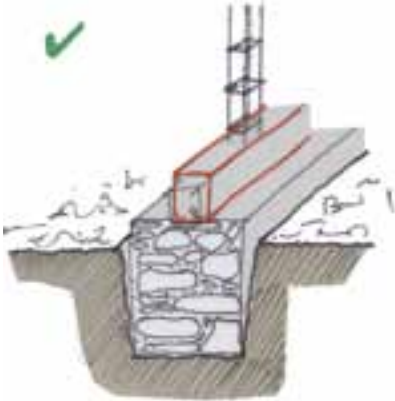

The ring beam, running along the whole perimeter of the walls, connects the walls to each other so that external forces will be absorbed by the structure as a whole.

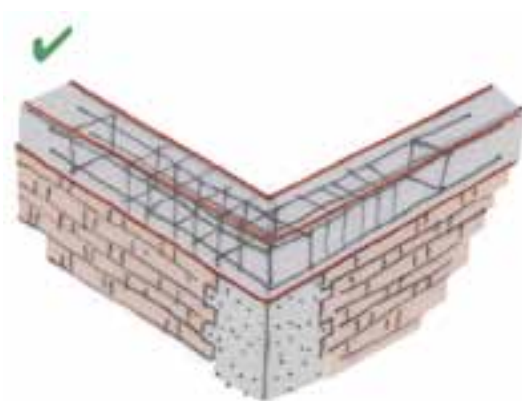

### *Timber-framed buildings*

Make strong timber-framed walls using vertical and horizontal members, braced horizontally and diagonally to resist movement.

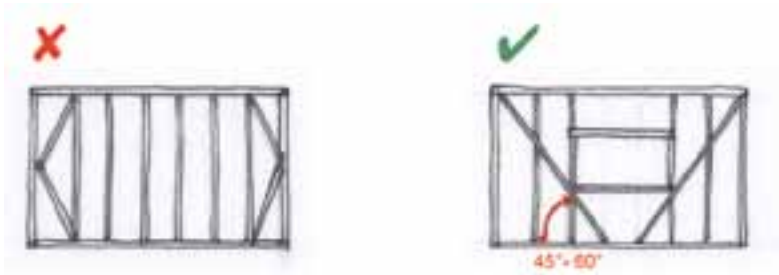

Ensure that the timbers are strongly joined to each other and that the frame is well anchored to foundations. The shelter needs to be securely bolted on to the foundations.

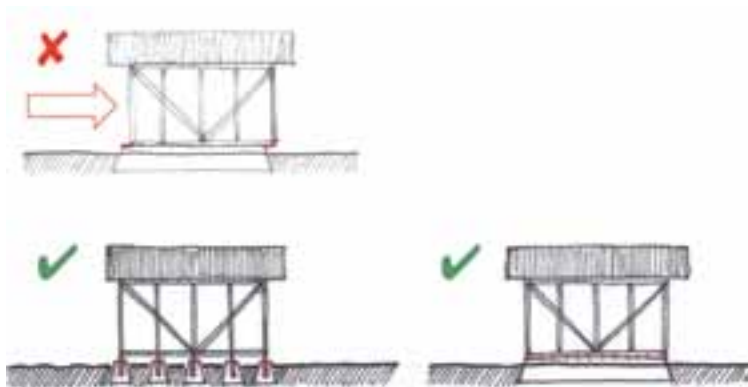

The timber pole is to be cast into the concrete pad. The nails create a better connection between the timber and the surrounding concrete.

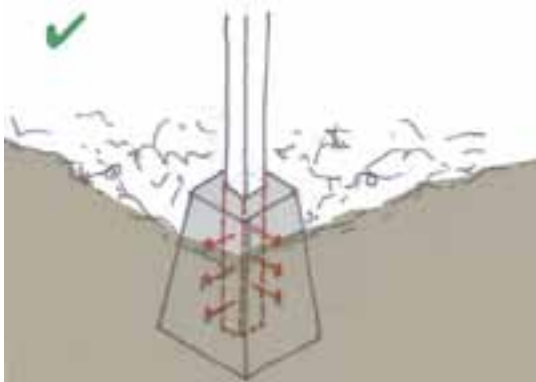

J-shaped anchors that are poured into the concrete of the plinth beam connect the strip foundation to the timber structure.

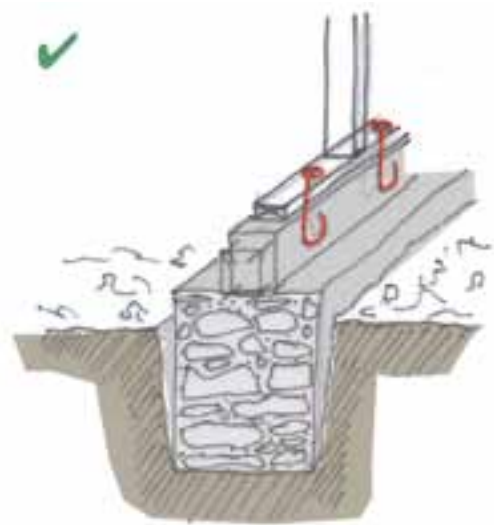

### Floors

Make sure that the floors are well braced and tied firmly into the walls to strengthen both walls and floors, reducing the risk of collapse.

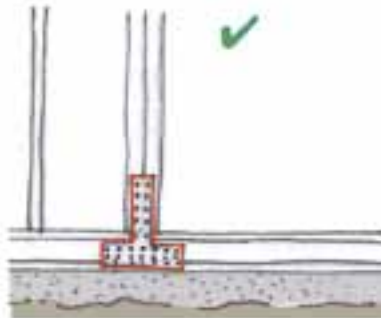
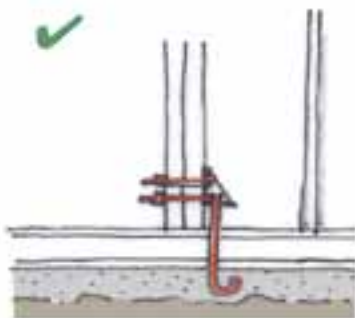

A J-bolt, connected to a bracket on the vertical timber, anchors the timber to the foundation.

A nailed T-strap connects the vertical timber to the floor.

A wooden post is placed in the hole made for the pad foundations. For a better connection between the post and the surrounding concrete, nails are fixed to each side of the post.

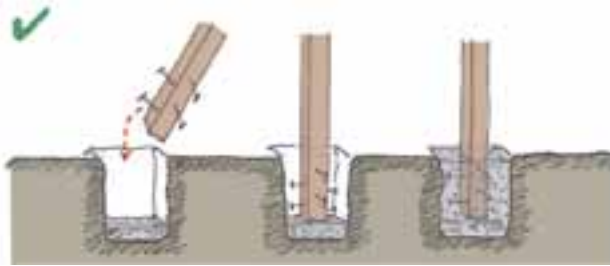

### Roof

Use strong but light roofing such as of timber or steel truss construction.



Only use concrete roofing where walls are sufficiently strong to support this material.

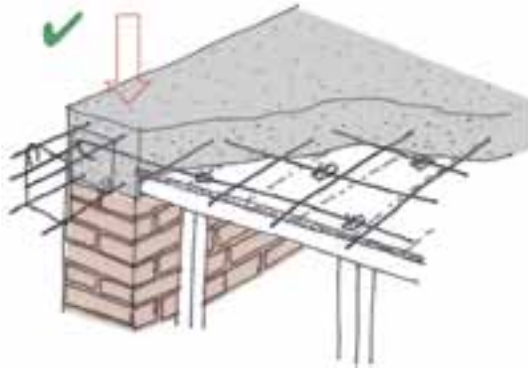

### Preparedness

- Although it is known which places are more at risk of earthquakes, it is not possible to provide warning of their occurrence, which makes it all the more important that shelters are built and maintained for safety.
- Shelters should be designed so it is easy to get out of them quickly from all rooms.
- Doorways should be strongly built so they do not collapse and block the exit.
- The community should know how to react and respond to earthquakes.
- Evacuation procedures should be practised in settlements and public buildings.

### 4.3 Strong winds

#### Site and settlement

One of the most important ways to protect shelters from strong winds is to build them in sheltered positions.

The buildings should be sheltered by the shape of the land, to protect them from strong winds and also from tidal surges in coastal areas.



Buildings should be sheltered by windbreaks, to protect them from strong winds. They can also be shielded from the wind forces by vegetation barriers.

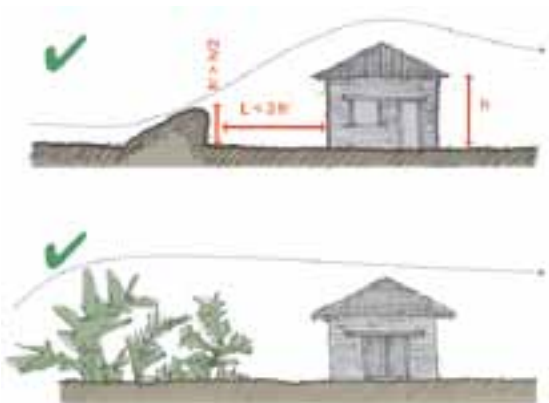

Small buildings should be far enough away from large trees that might fall over.

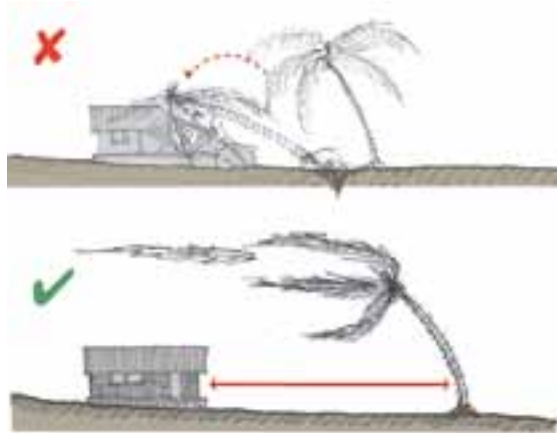

The planning of the settlement influences reduction of the wind forces.

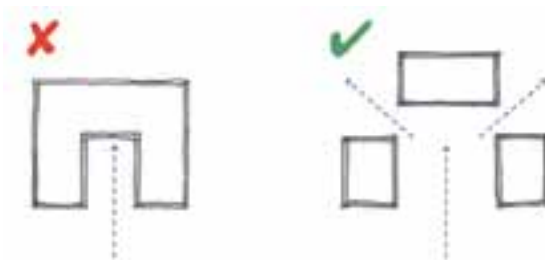

The shorter elevation of a building should face towards the dominant direction of strong winds to reduce wind pressure on the construction.

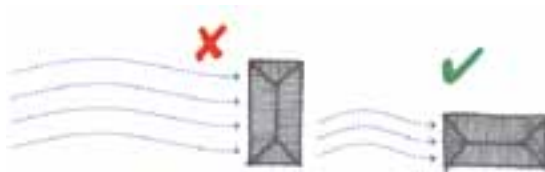

Collective buildings used for public shelter during strong winds should be easily accessible, well sheltered and resistant to wind forces.

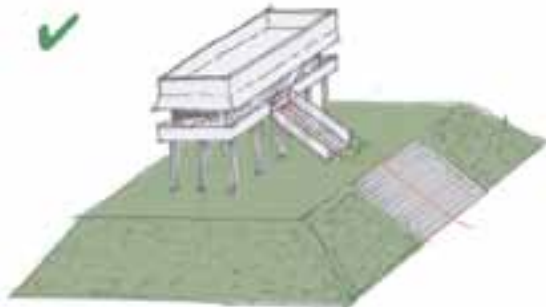

### Construction

Shelters and buildings need to be designed and built to withstand the forces created by the wind. Heavy buildings are naturally more resistant. Buildings made with lightweight materials need strong anchors, fixings and bracing to make them resistant to strong winds. Below are some measures to reduce the vulnerability of shelter to wind forces.

### Foundations

Build the shelter on foundations or piling that rest on stable ground.



Use good-quality materials (masonry and mortar materials) for bases and foundation walls.

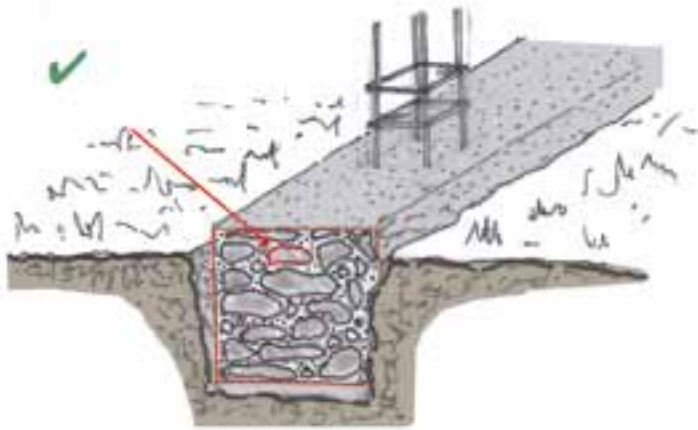

Foundations or piling should be sufficient to anchor light buildings firmly to the ground. If the connection between the two is not adequate, the wind forces can lift the wooden structure from the foundation.

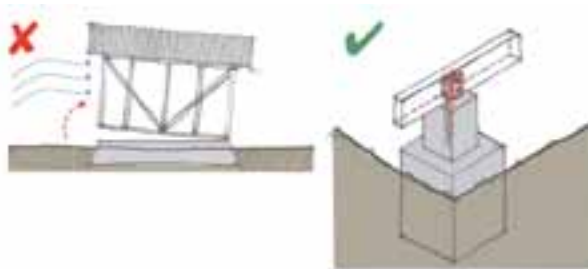

## WALLS AND OPENINGS

### Masonry buildings

Ensure walls are of sufficient thickness and strongly bonded together for wind resistance. There should also be adequate weight on the foundations or piling to prevent the structure lifting and moving off the ground.

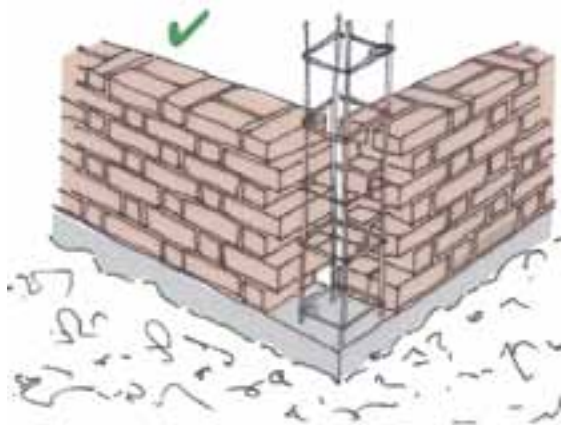

Provide shutters or other protection on openings and use resistant glass or plastic for glazing. Shutters hinged along the top of window frames are preferred as these will not suddenly open and let in the wind, which could result in an increased internal pressure and cause the roof to blow off or the walls to collapse.



### *Timber-framed buildings*

Make sure that the floors are well braced and tied firmly into the walls to strengthen both walls and floors, reducing the risk of them collapsing.



Make strong walls with vertical and horizontal timbers and with sufficient bracing to resist the horizontal forces of strong winds.

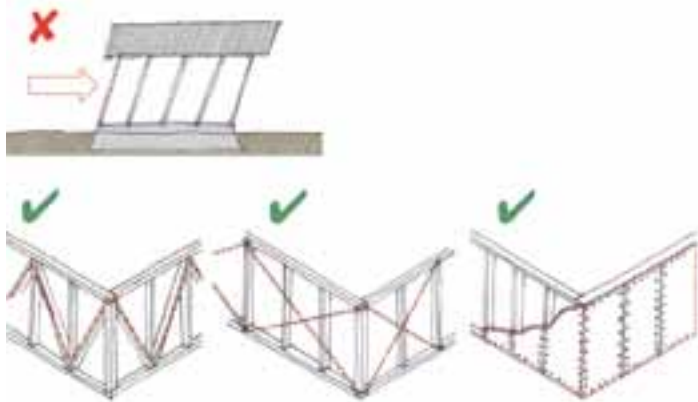

Ensure that the timbers are strongly fixed to each other and that the frame is well anchored to foundations or piling to avoid the building lifting off the ground.

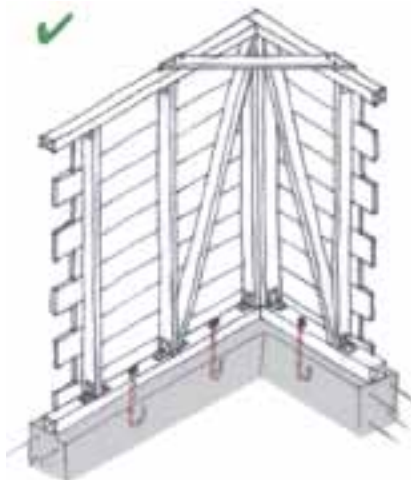

All structural elements should be connected between each other by hurricane straps and the structure should be braced to resist wind pressure, water pressure and forces caused by earthquakes. Hurricane straps and corner braces must be added to secure studs at top and base plates and at corners of the structure.



Studs around windows and doors should be doubled as openings weaken the structure.



### Roof

Build the roof with a minimum slope of 30 degrees (and maximum of 40 degrees). This reduces the effect of suction and uplift from the wind.



Build the roof with a hipped or conical shape, rather than with gables, to reduce the risk of the roof lifting off.



Roof overhangs can cause uplifting of the roof structure due to strong winds, if they are connected to the main roof structure. Overhangs should therefore be structurally disconnected.

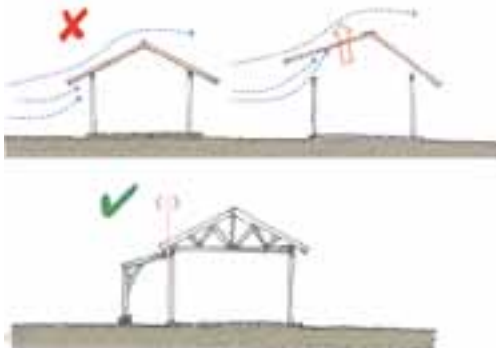

The roof overhang should be at a minimum to avoid the roof being uplifted by strong winds. The maximum roof overhang recommended is between 20 and 30 centimetres.



The roof elements should be tied together securely and be well fixed to the walls; the connections are most important. The nails, screws and metal straps should be galvanized or protected from rust. The rafters need to be connected directly to the ring beam with hurricane straps.

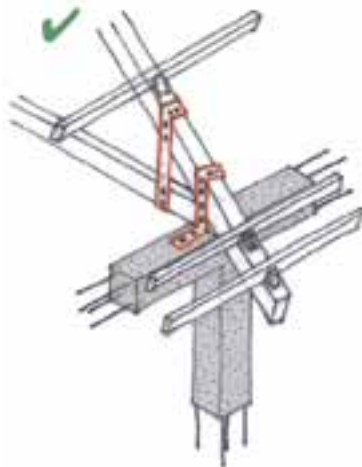

Hurricane straps are used to connect the rafters to each other and to connect the rafters to the ridge beam.

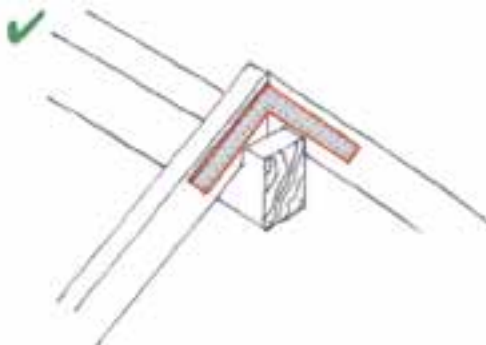

Ensure there is sufficient fixing of cover material to the roof structure for adequate resistance to strong winds. The galvanized sheets should be fixed with roofing screws or large-cap roofing nails. These sheets should overlap two complete corrugations.



On the ridge and the eaves, galvanized sheets are nailed at the top of every single corrugation. On the laths, every other corrugation is nailed. The galvanized sheets should overhang 5 centimetres from the boards. One galvanized sheet is not enough to cover the entire roof slope; there should be a lateral overlap of two complete corrugations between two sheets. The overlap should be in the direction of the prevailing wind. Transversal overlaps should be avoided if possible. For a roof slope between 20 and 30 degrees, the overlap should be 15 centimetres. If the roof pitch is less than 30 degrees, the overlap should be at least 30 centimetres.



If there is a lean-to or veranda attached to the main building, make sure it has an independent roof structure so that if its roof lifts due to high winds, it does not damage the roof of the main building.

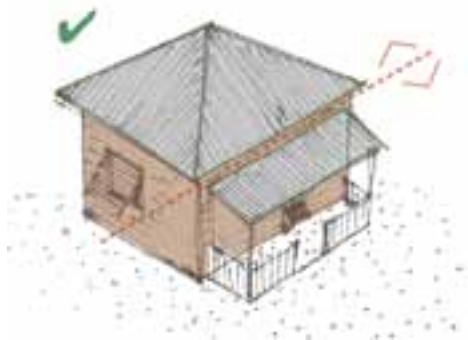

### Preparedness

- ↘ Identify responsibility for gathering and spreading early warning of strong winds at community level.
- ↘ Encourage householders to remove or tie down loose materials that may be carried by strong winds and cause damage.
- ↘ Ensure that communal cyclone shelter is accessible and has adequate supplies.
- ↘ The community should know how to react and respond to storm warnings.
- ↘ Evacuation procedures should be practised in settlements and public buildings.

## 4.4 Floods

### Siting and settlement

The most important way to protect shelter from floods is to build in a place that is not likely to be flooded.

Shelters and settlements should be sited above the highest recorded flood level, or should be protected by embankments that are sufficiently high and strong enough.

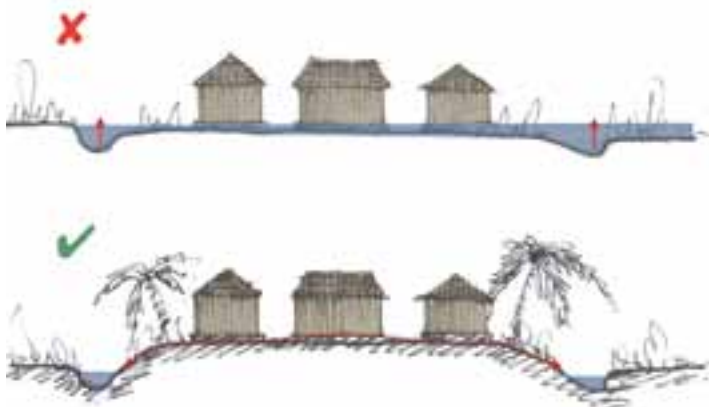

Shelters and settlements should be sited away from locations at risk of landslides and rockfalls during heavy rains.



Shelters and settlements should be sited well away from the likely path of flash flooding.



Shelters and settlements should be on stable ground to avoid the risk of collapse or landslides during flooding.



The settlement may be laid out so that access is easy for evacuation and rescue.

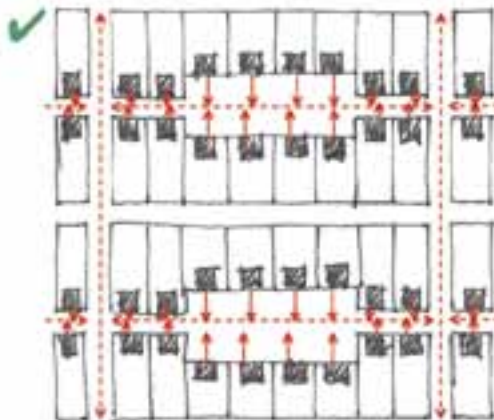

There should be an adequate and well-maintained drainage system in the settlement to carry away storm and flood water.



Protect shelters and settlements from erosion using ground-cover plants.

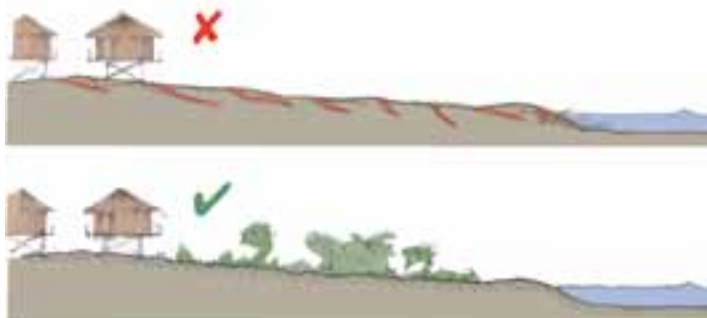

Lines of trees and bushes should be planted to create barriers to river and tidal surges.

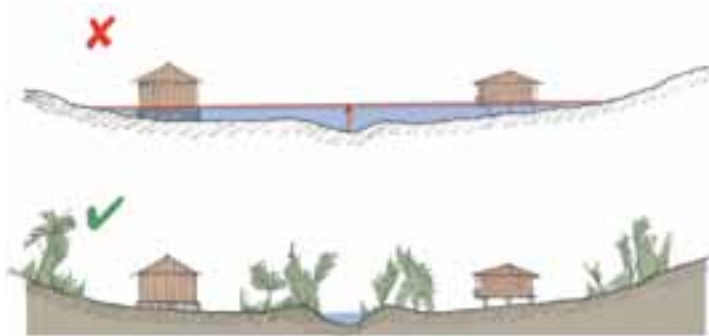

Collective buildings used for public shelter during flooding should be easily accessible, sited above known flood levels, and be resistant to floods.



### **Construction**

The next most important point is to build a strong building that can withstand the forces created by the moving water, and which will not collapse when wet. Below are some measures to reduce the vulnerability of shelter to floods.

### Foundations

Build the shelter on foundations or piling that rest on stable ground.



Provide good drainage to the shelter and settlement to minimize erosion of foundations. Protect the base of the walls from erosion by rainwater by using gutters, downpipes and drainage. Badly maintained drainage systems cause saturation of the ground leading to instability.

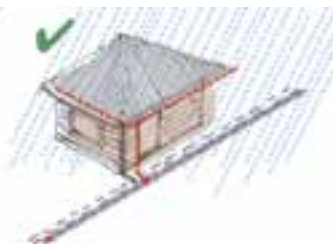

Provide drainage close to the foundations, to reduce water pressure on the foundations and to the floor of the building.



Build the shelter on water-resistant foundations and footings or piling to resist water pressure and remain resistant when wet. Plastic sheeting can be put between the ground and the foundations to further protect the structure.



Build sufficiently deep foundations to avoid undercutting by moving water.



Build the shelter on stilts where appropriate.



### Walls and openings

Build with heavy walls, or ensure that light walls are well anchored to foundations or piling, to be able to resist pressure from water.

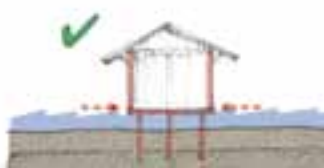

Use water-resistant wall materials, or add a protective coating to resist waterlogging and retain strength during heavy rain and flooding. In this case, consider the risk of long-term damage to earth walls if they cannot 'breathe'. Applying a mortar mixed with sharp or coarse sand to a wall will create a waterproof barrier.



In some cases, provide openings near the bottom of walls to allow flood water to move through the shelter without causing it to collapse.

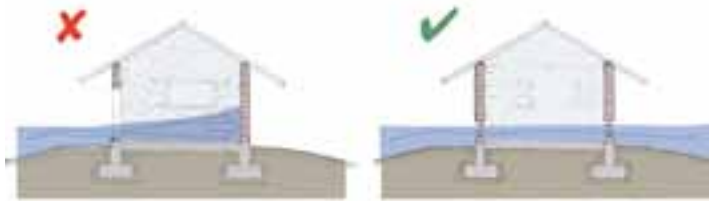

Doors and windows should be placed in opposite walls to allow water from flash floods to flow out of the shelter, which will prevent the walls from collapsing due to high pressure caused by the water.

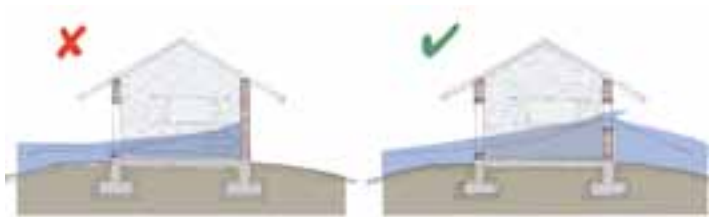

### Floors

Raise ground floors above known flood levels to prevent flood water from entering the shelter.

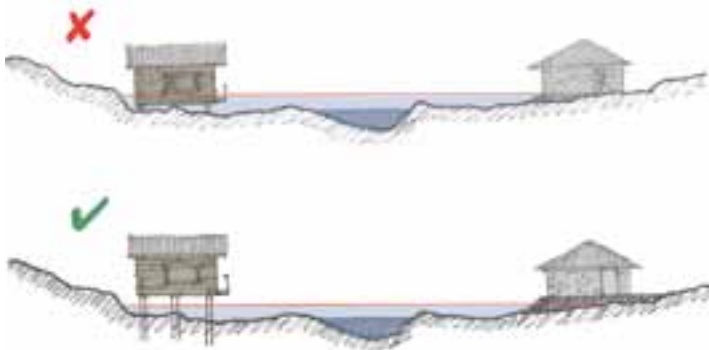

Provide a raised platform in or beside the shelter to allow people and possessions to be above the flood level.



### Roof

Provide rainwater gutters to protect the base of walls from heavy rain, and to ensure that the water runs away from the walls. Drains to take away rainwater falling from the roof (if no gutters) are recommended.

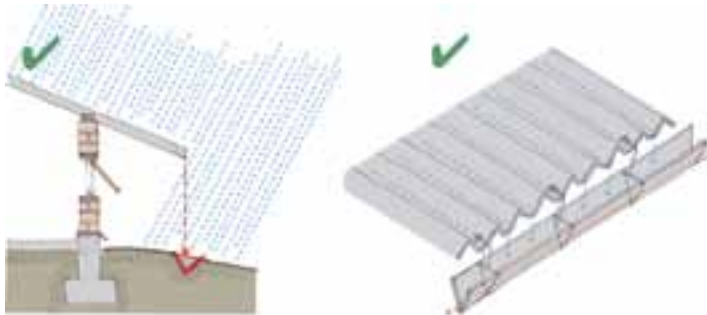

### Preparedness

- Identify responsibility for gathering and spreading early warning of floods at community level.
- Keep supplies of sandbags at household level for protecting shelter.
- Ensure that communal flood shelter is accessible and has adequate supplies.
- The community should know how to react and respond to flood warnings.
- Evacuation procedures should be practised in settlements and public buildings.

## 4.5 Maintenance

Regular inspections enable planning of maintenance and repairs of the shelter's structure and materials. This is necessary to maintain the strength of the shelter, making it safer and less vulnerable when a disaster occurs. Maintenance also reduces the need for emergency repairs, which can save money in the long term.

If any event occurs such as an earthquake, storm or flood that could have caused damage, the building or shelter should be thoroughly inspected to ensure it has not been weakened. Repairs should be carried out promptly where required.

When designing the building or shelter, keep in mind easy and self-evident maintenance. It is important that the materials used can be repaired locally. A checklist of regular inspections needed should be handed over to the house owner.

The following inspections should be carried out on a regular basis to ensure buildings are properly maintained:

- ↘ Ensure that firebreaks in the settlement are kept free of dry vegetation and are not built on.
- ↘ Accesses should be kept free of plants and rubbish in order not to hinder evacuation when needed.
- ↘ Clean or replace parts of the building's structure that are decaying as they weaken the construction.
- ↘ Timber should be checked to see if there are termites, pests or rot, as these can decrease structural resistance of timber. It is most important to keep the timber in buildings dry, well ventilated and above the ground.
- ↘ The timber should be treated before it is on the construction site. On-site painting treatments should take place after joinery work as termites can bore through freshly cut timber at the joints. A mix of one part waste engine oil to two parts diesel (1:2) can be used as treatment.

Simple measures such as a rodent screen or a termite groove can be integrated to protect the timber. Train communities to reduce termite-friendly habitats by clearing fallen timber and storing timber such as firewood away from buildings.



#### 4.6 Modifications

Modifications that include introducing any of the features listed above to an existing building help to reduce vulnerability to hazards.

The following modifications tend to weaken the structure. They should only be carried out by a qualified builder, or avoided if possible.

Removing internal walls

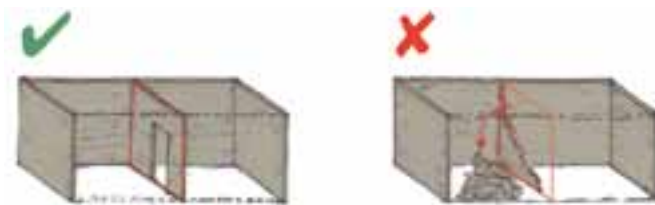

Increasing the number and size of openings

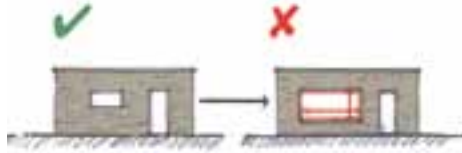

Removing elements from timber-framed walls (such as when a new opening is made)



Adding weight to the upper part of the building (for instance by extending upwards)

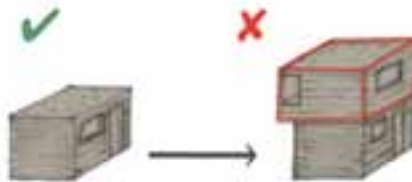

Undermining walls (for instance for the purpose of introducing pipes)

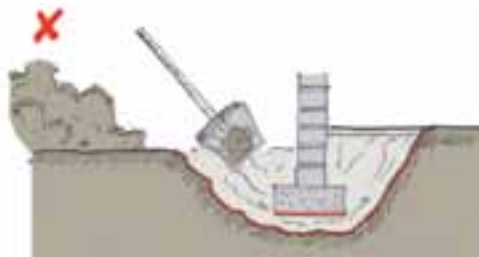

### Adding extensions to existing structures



Adding fire hazards such as extensions built from flammable materials, craft activities etc.





## 5. Further information

---

- ↘ Asian Disaster Preparedness Center. *Design and construction of housing for flood-prone rural areas of Bangladesh*. Bangkok, ADPC, 2005.
- ↘ Coburn A, Hughes R, Pomonis A, Spence R. *Technical principles for building safety*. London, Intermediate Technology Publications, 1995.
- ↘ Safe Shelter Initiative, National Development Foundation Dominica. *Make the right connections: a manual on safe construction techniques*, 1999.
- ↘ Rumöh Löen DW, Löen Syurga, British Red Cross, Palang Merah Indonesia. *Antiseismic basic guidelines*.



# The Fundamental Principles of the International Red Cross and Red Crescent Movement

**Humanity** The International Red Cross and Red Crescent Movement, born of a desire to bring assistance without discrimination to the wounded on the battlefield, endeavours, in its international and national capacity, to prevent and alleviate human suffering wherever it may be found. Its purpose is to protect life and health and to ensure respect for the human being. It promotes mutual understanding, friendship, cooperation and lasting peace amongst all peoples.

**Impartiality** It makes no discrimination as to nationality, race, religious beliefs, class or political opinions. It endeavours to relieve the suffering of individuals, being guided solely by their needs, and to give priority to the most urgent cases of distress.

**Neutrality** In order to enjoy the confidence of all, the Movement may not take sides in hostilities or engage at any time in controversies of a political, racial, religious or ideological nature.

**Independence** The Movement is independent. The National Societies, while auxiliaries in the humanitarian services of their governments and subject to the laws of their respective countries, must always maintain their autonomy so that they may be able at all times to act in accordance with the principles of the Movement.

**Voluntary service** It is a voluntary relief movement not prompted in any manner by desire for gain.

**Unity** There can be only one Red Cross or Red Crescent Society in any one country. It must be open to all. It must carry on its humanitarian work throughout its territory.

**Universality** The International Red Cross and Red Crescent Movement, in which all societies have equal status and share equal responsibilities and duties in helping each other, is worldwide.

**For more information on this IFRC publication,  
please contact:**

**International Federation of  
Red Cross and Red Crescent Societies**

**Graham Saunders**

Head, Shelter and Settlements Department

E-mail: [graham.saunders@ifrc.org](mailto:graham.saunders@ifrc.org)

Tel: +41 22 730 42 41

Fax: +41 22 733 03 95