

1 LAGA 'I HE FAKAVA'E 'OKU MALOHI

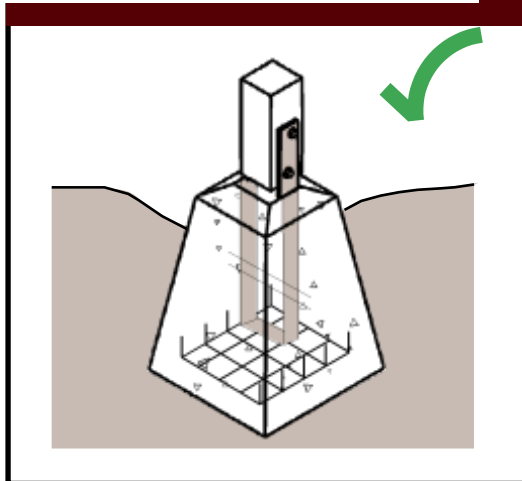

2 NO'O E HOKO MEI LALO KI 'OLUNGA

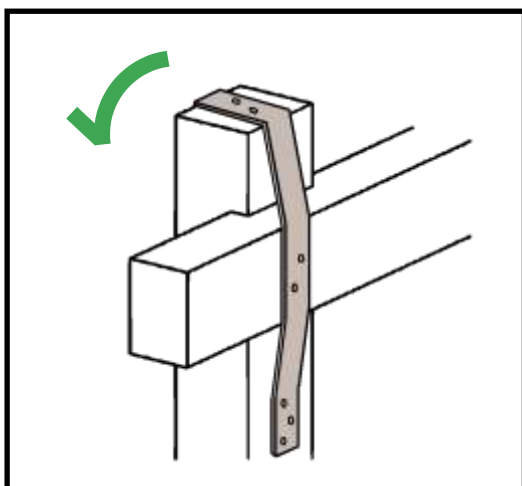

3 HA'I KE NE MATU'UAKI E MATANGI

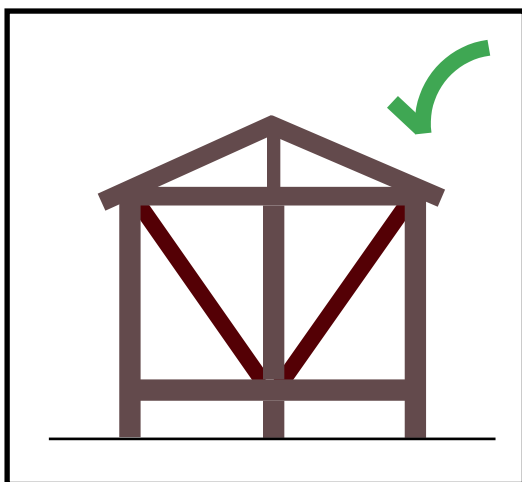

4 HOKO KE MALOHI

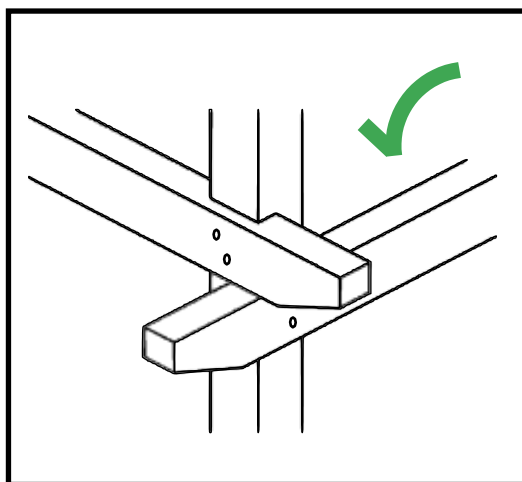

5 KOE FALE LELEI 'OKU FIEMA'U E 'ATO LELEI

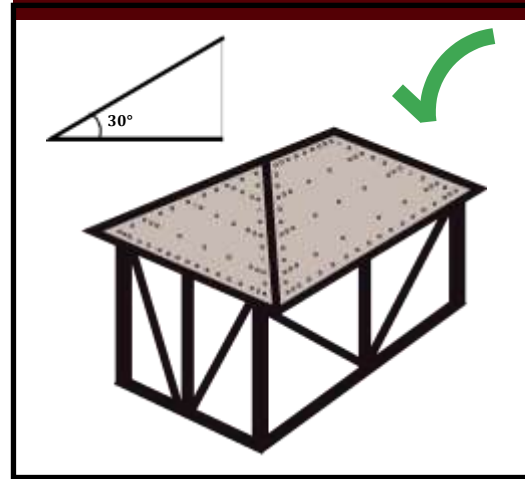

8 MO'UI MATEUTEU MA'U PE



7 KOHA FA'UNGA FAINGOFUA TENE MALU'I KOE HAO

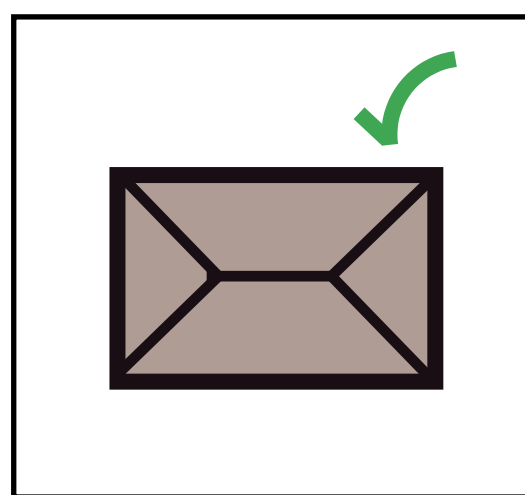

6 TU'U'ANGA 'O E FALE KE MALU

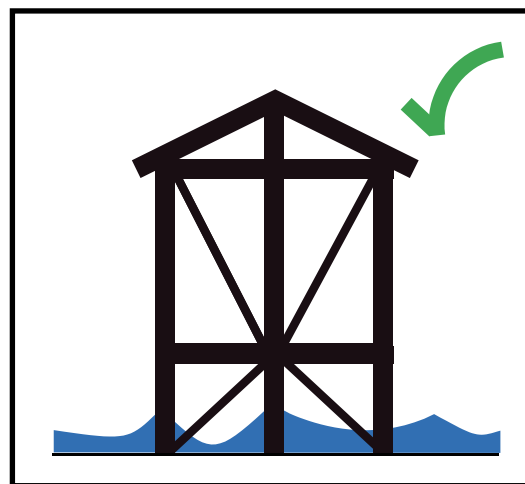

'OKU HANGA 'E HE SAIKOLONE KO GITA 'O FAKAHA MAI KIATE KITAUTOLU 'OKU FIEMA'U KE LANGA HOTAU FALE KE MALOHI.'OKU 'I AI E NGAHI TEFITO'I FEKAU 'E 8 KI HANO FAKALELE'I HO FALE PE KO HONO TOE LANGA KE MALOHI ANGE.

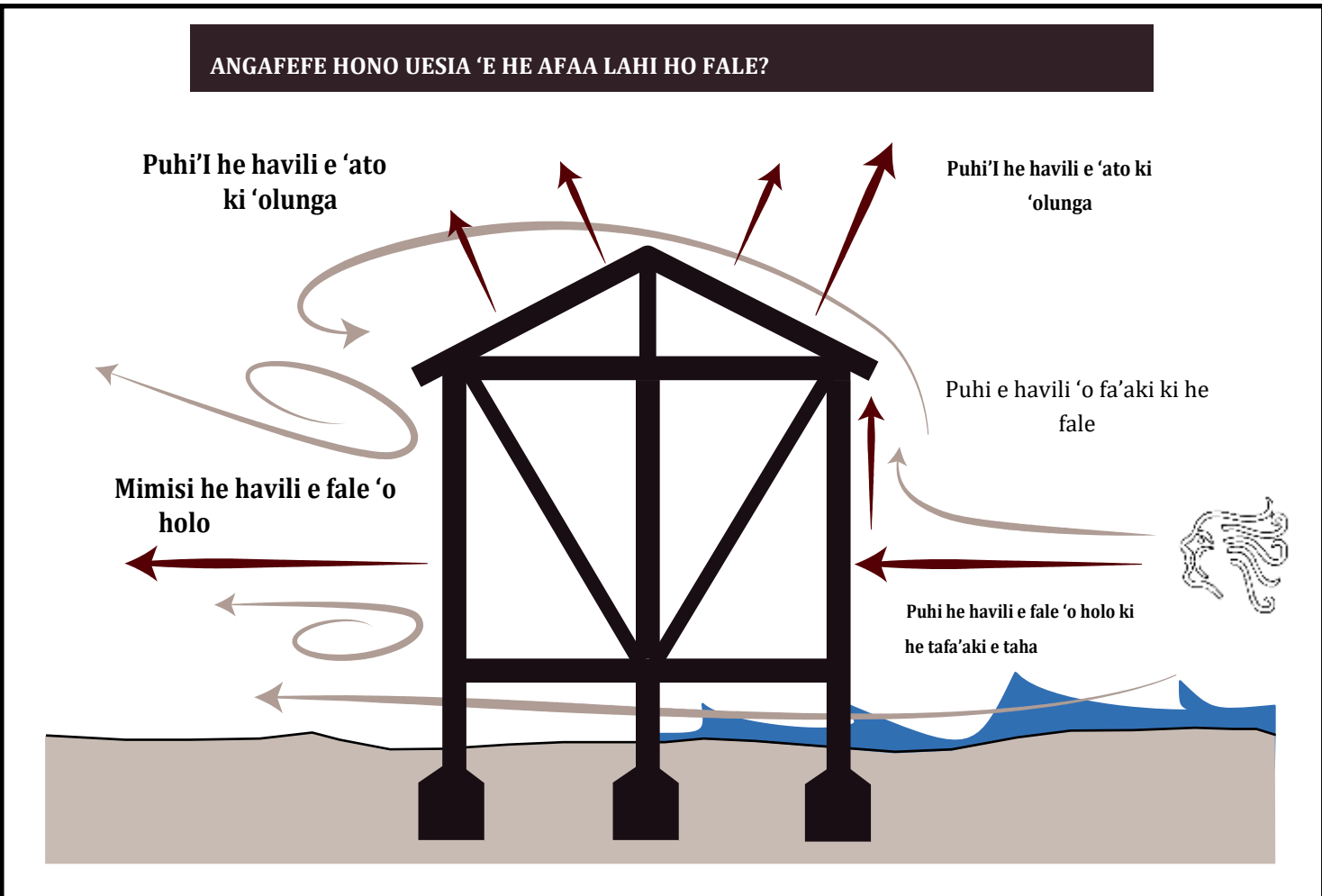

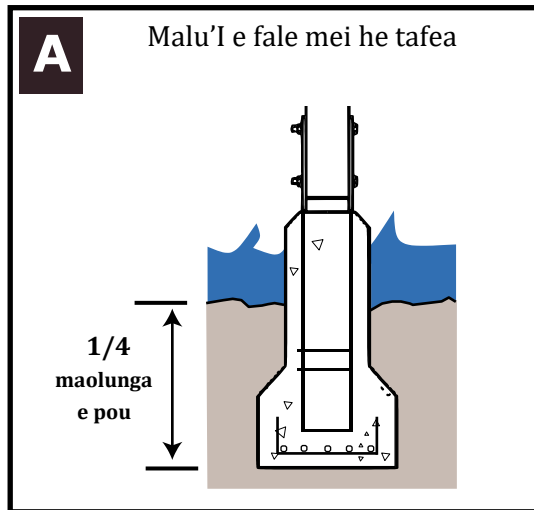

Langa 'I he fakava'e 'oku malohi



Koe fakava'e 'oku mahu'inga 'aupito he koia 'oku ne fakama'u e fale ki he kelekele. Fakapapau'I ma'u pe 'oku fe'unga mo taau e feitu'u 'oku fai ai e langa mo e tu'u'anga 'o e fale 'e lava ke hao mei ha matangi malohi, mofuike mo e tafea

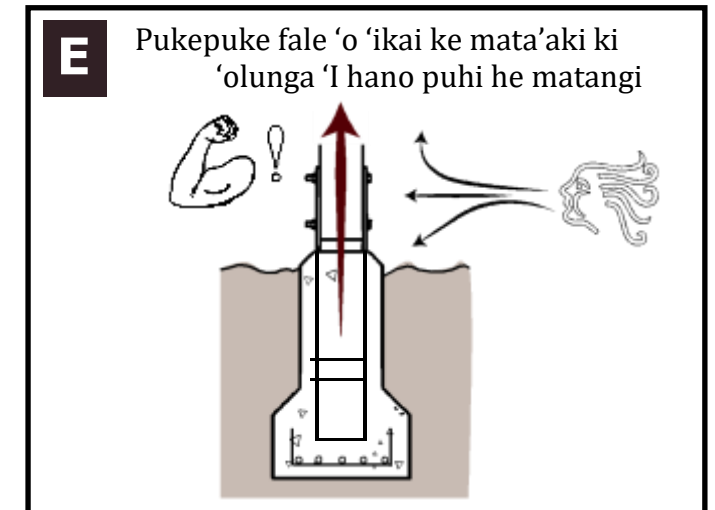
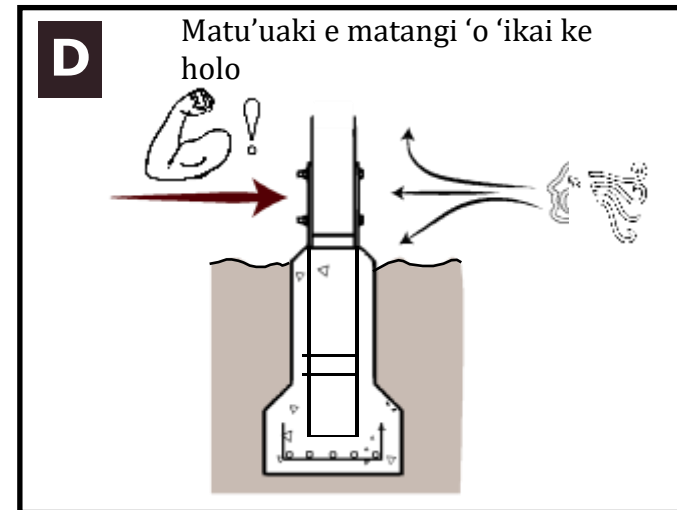
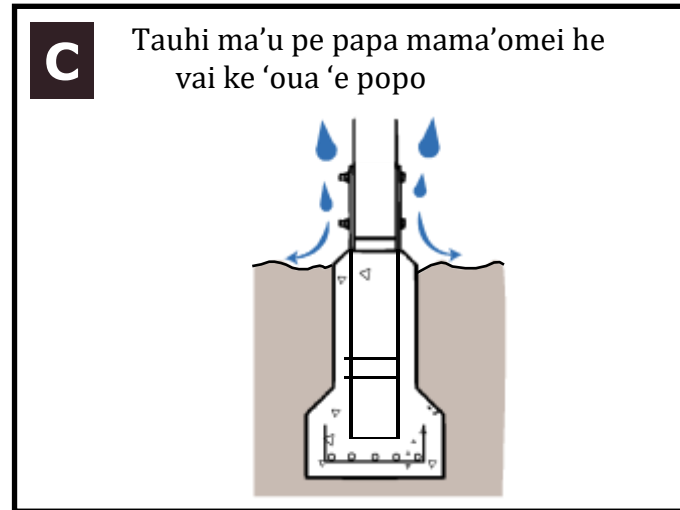
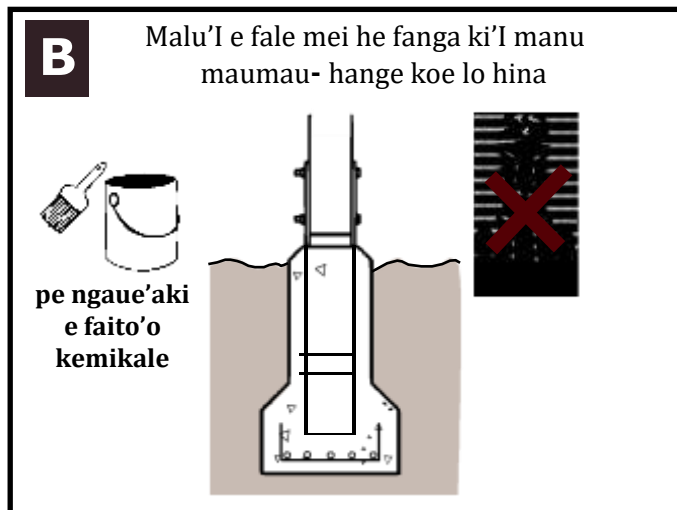
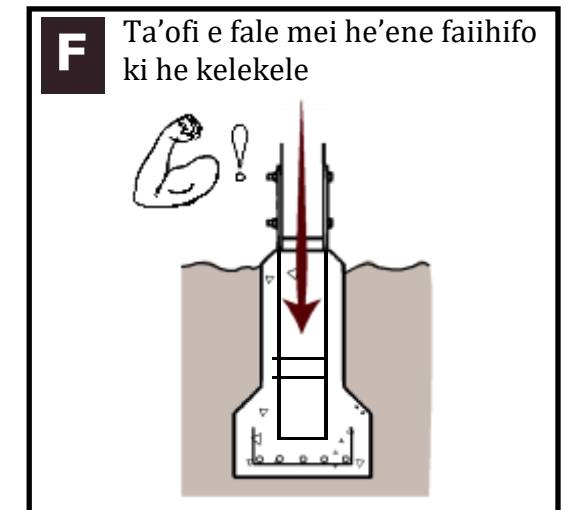

KOE HA E NGAARI NAUNAU TEU NGAUE'AKI KI HANO LANGA HA FAKAVA'E KI HA'AKU FALE?

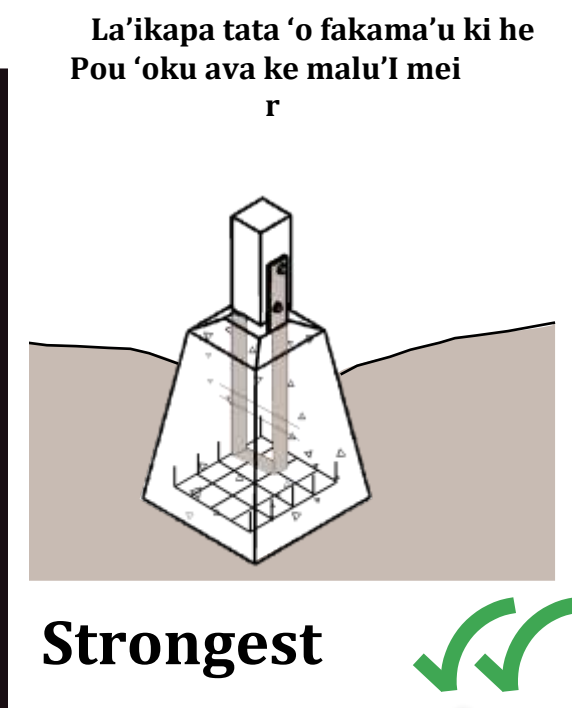
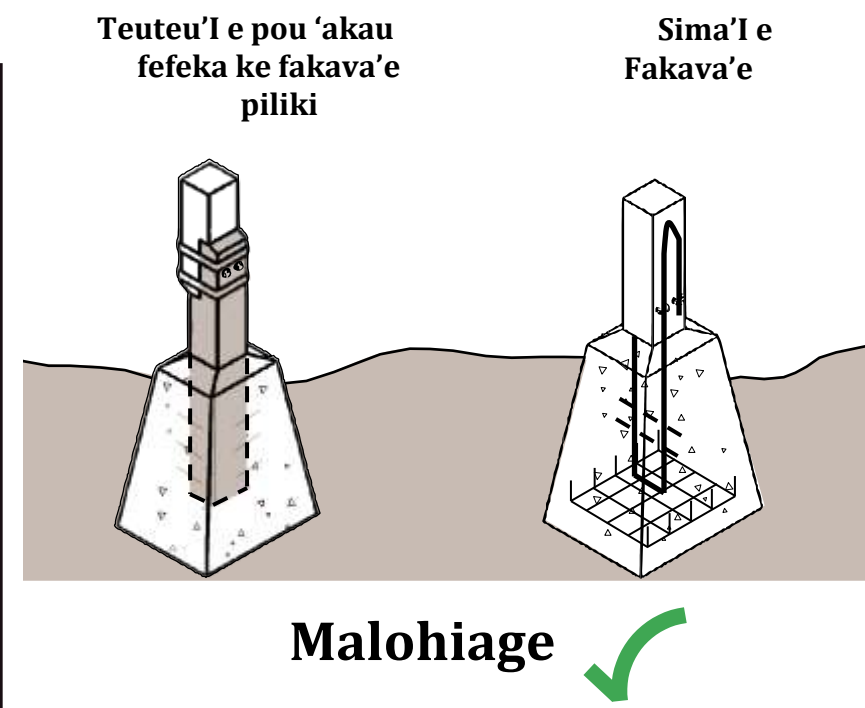
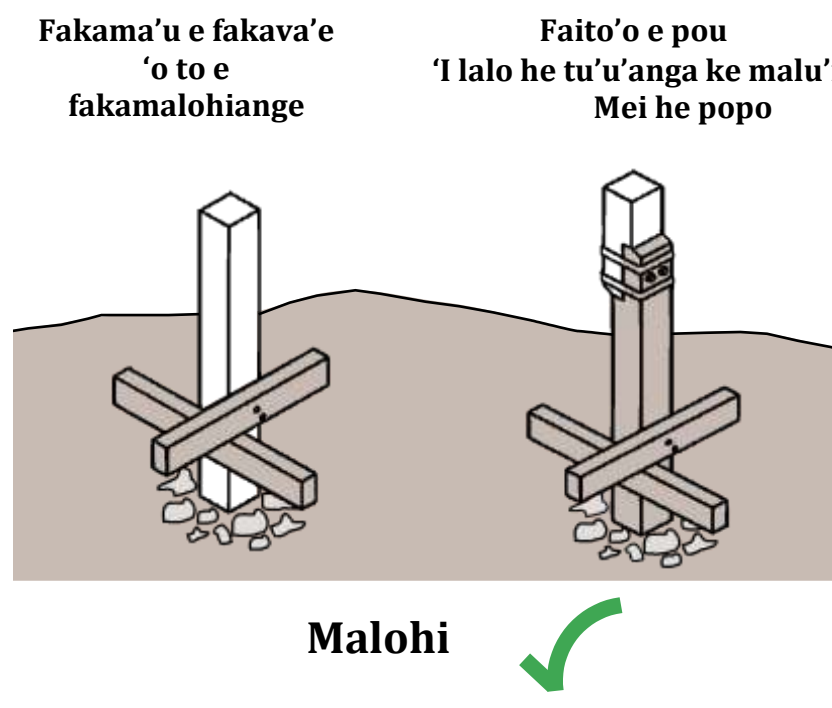
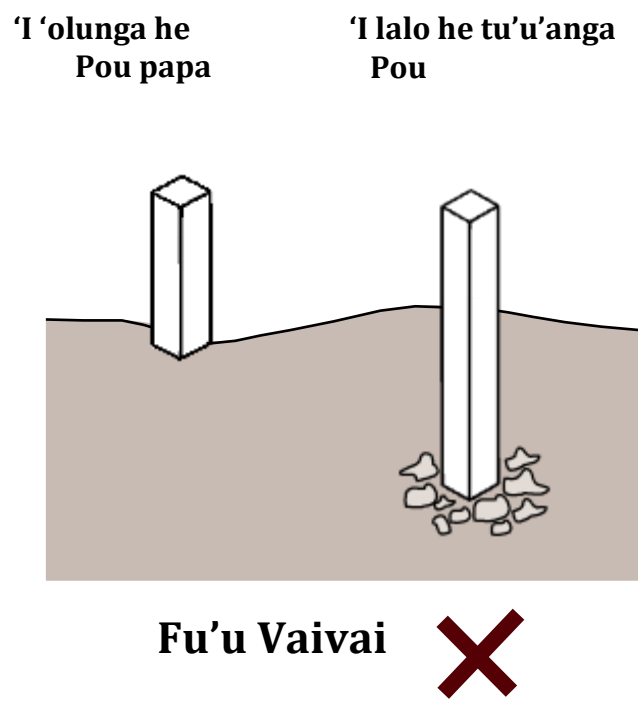

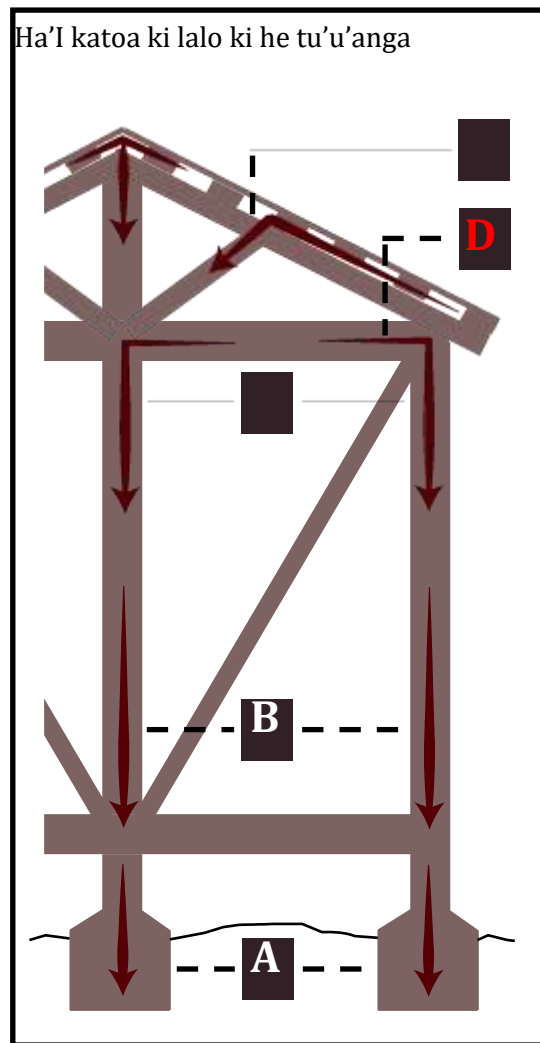

HA'I E HOKO MEI LALO KI 'OLUNGA

'I ha afaa lahi 'e malava ke haea ai ho fale. Koia ai ha'I e konga kotoa pe 'o e fale mei he tu'u'anga. Kamata fakakaukau'ia mei he kamata'anga

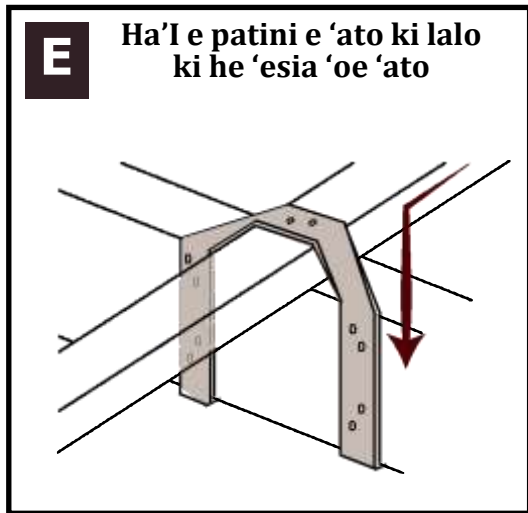
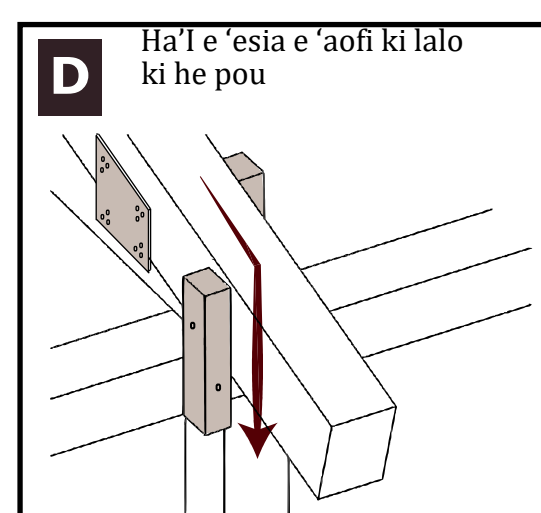
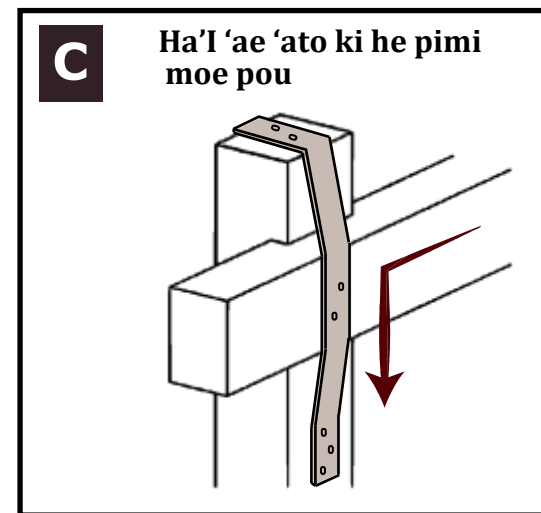
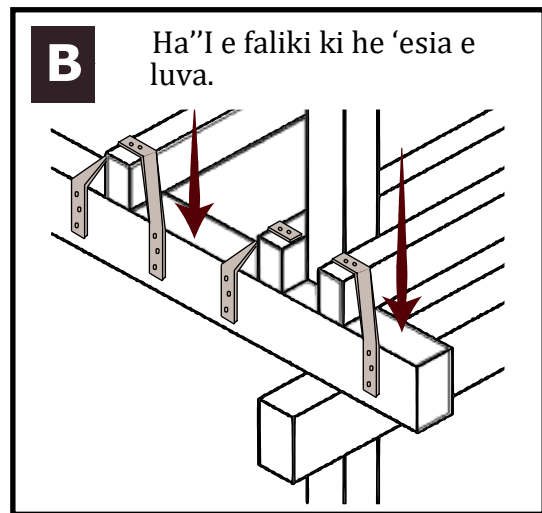
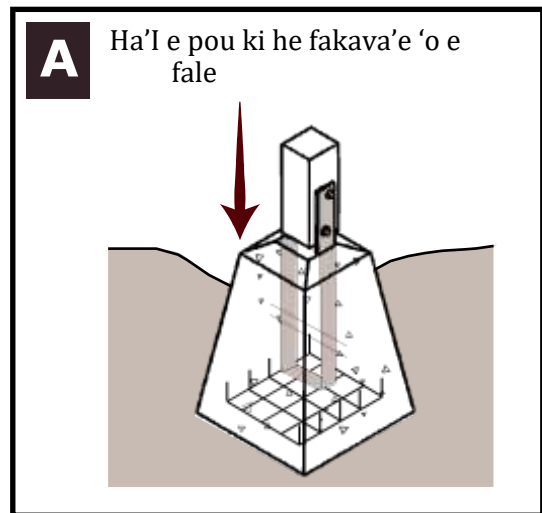

KO E HA E ME'A TEU ALA NGAUE'AKI KE HA'I 'AKI HOKU FALE?

MATANGI MALOHI 'OKU HA'U?

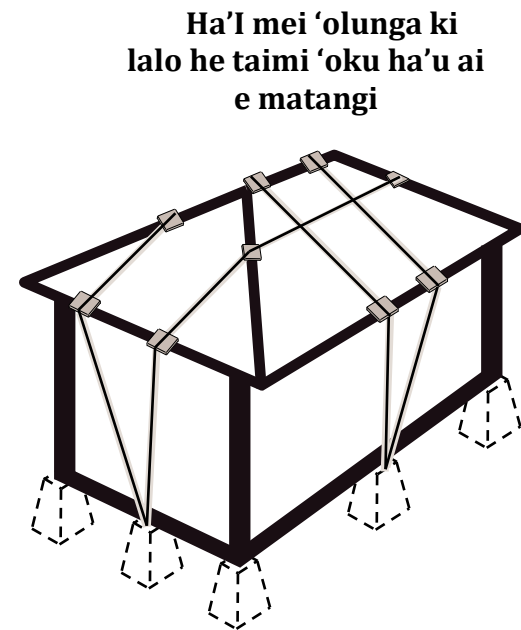
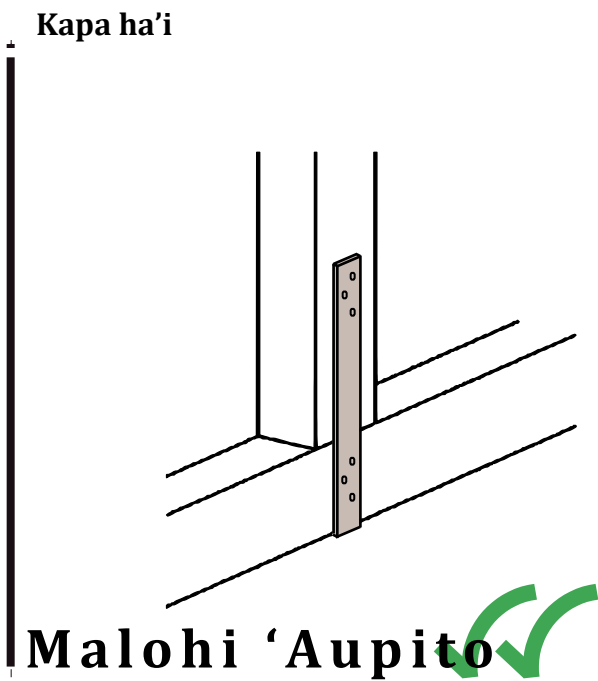
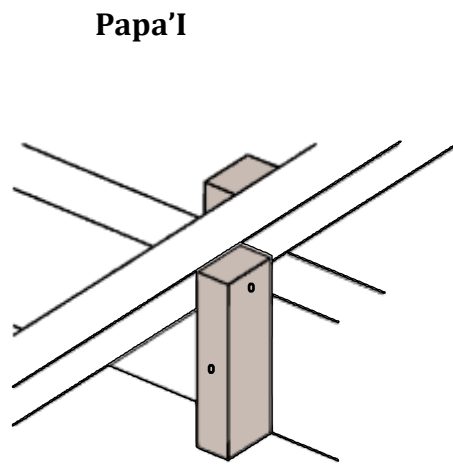
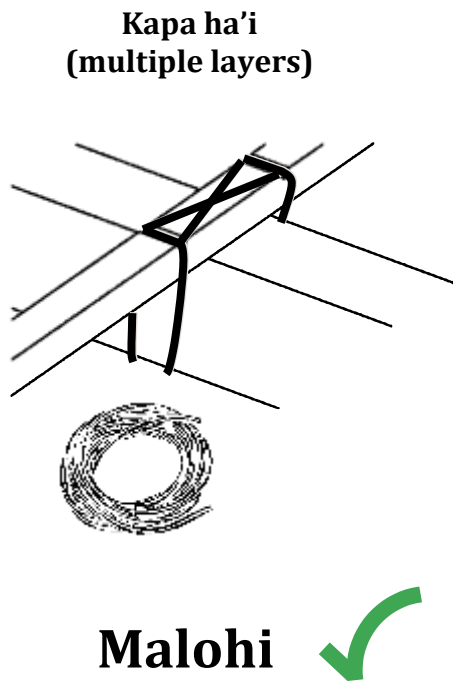
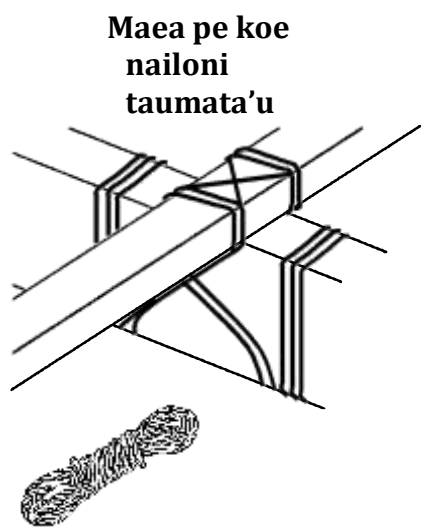

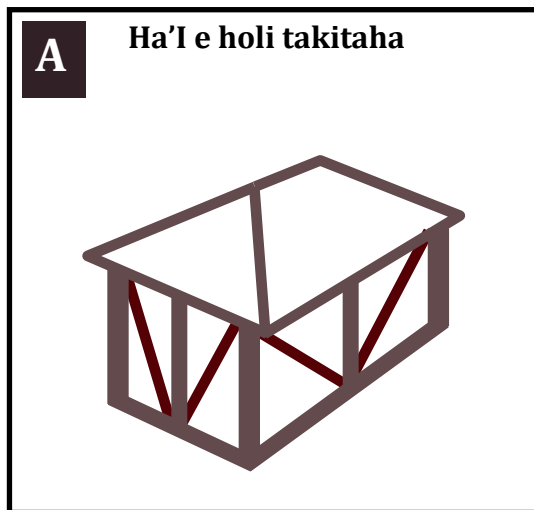

Ha'I ke ne matu'uaki e matangi



Koe malohi ange hono ha'I tene mata'ofi e holo moe movete ho fale he matangi. Ko e ha'I 'oku fiema'u ia ke malohi kene matu'uaki ho fale mei hono haveki 'e he matangi. ong its length or pulled apart. Brace between the strong points of your house.

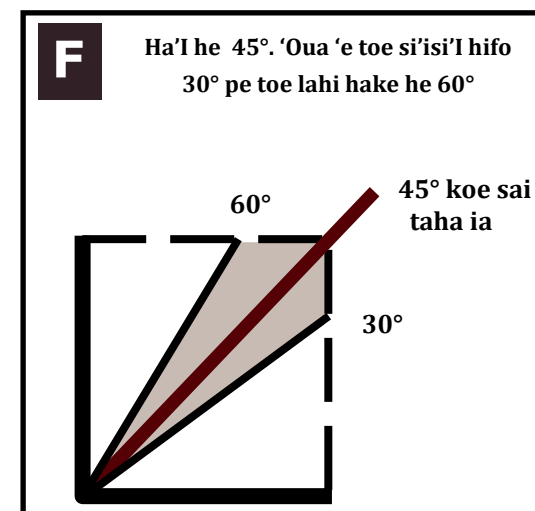
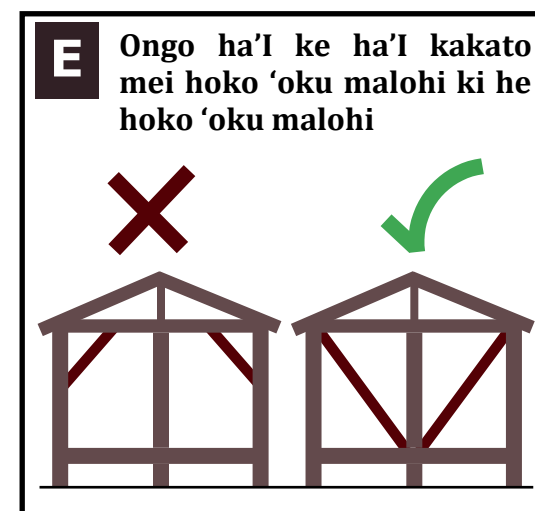
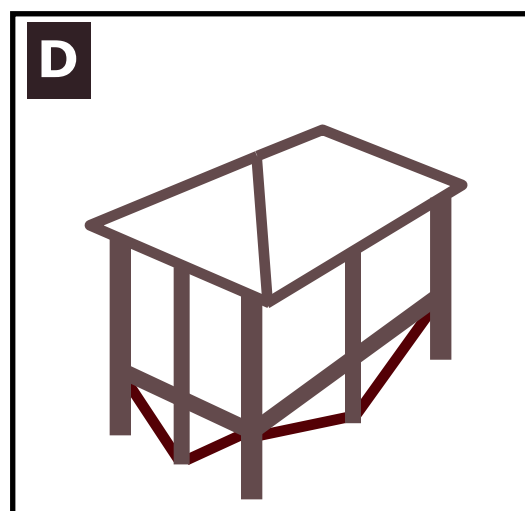
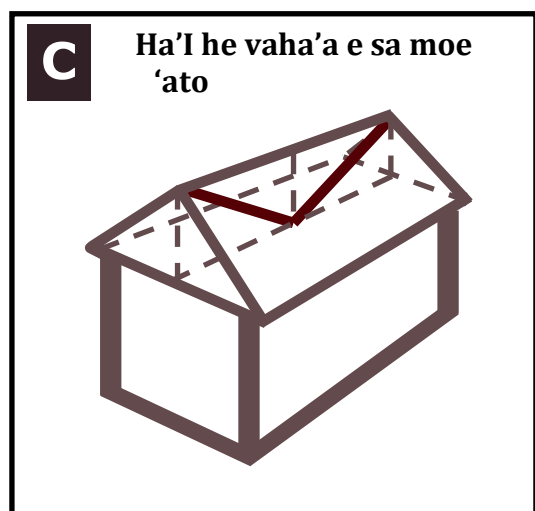
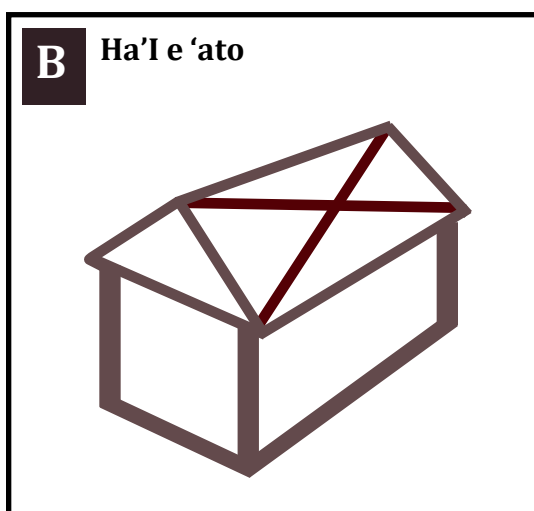

KOE HA E ME'A TEU NGAUE'AKI KE HA'I 'AKI HOKU FALE

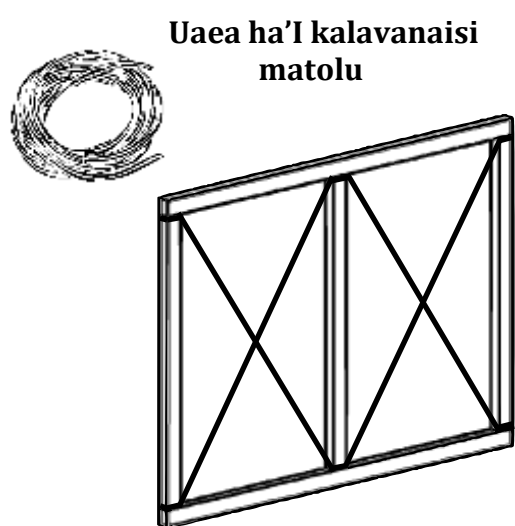

Malohi

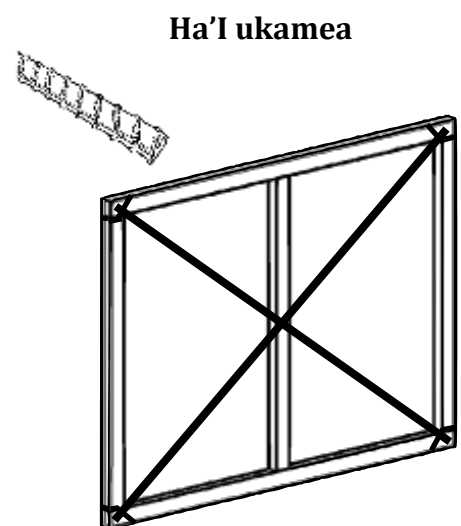

Malohi ange

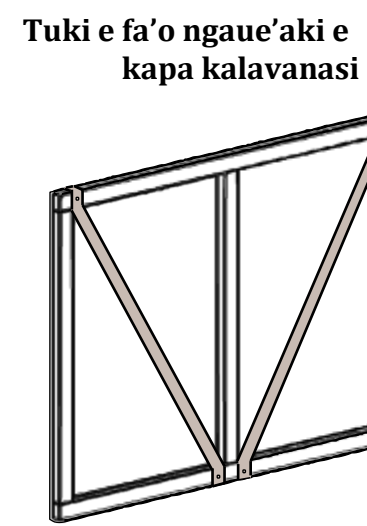
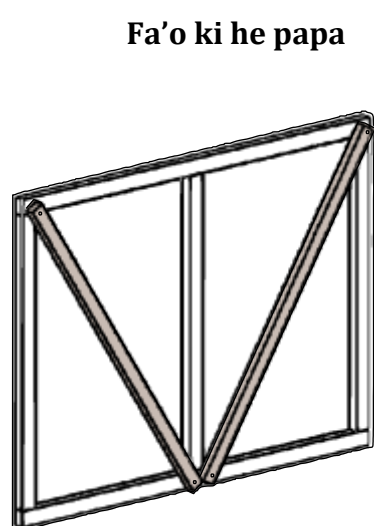

Malohi 'aupito



A Faka'ova e papa ke ova he hoko ke ta'ofi e fa'o mei hono fakamavaeua'I e papa



Ngaue'aki hoko 'oku malohi



Your house is only as strong as the weakest joint. Build every joint so it can't be pushed or pulled apart. Horizontal nails are better as they can't be pulled apart by the wind sucking your house up or pulling it down.



F Ngaue'aki e peleti kasete kene fakamalohi'I e hoko

B 'Oua 'e fu'u tu'utu'u e papa mei he tefito'I pou

C Offset nails to prevent timber splitting

D Tuki e fa'o he tuliki ke ne fakamalohi'I e hoko ke 'oua e mavaeua

E Ngaue'aki e kappa ha'I fakavetikale mo fakaholisonitale ke fakamalohi'I e hoko

KO E HA E ME'A TEU NGAUE'AKI KE FAKAMALOHI'I 'AKI E HOKO?

Fa'o 'e taha

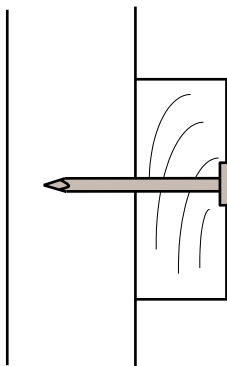

Fu'u Vaivai

Fa'o 'e ua

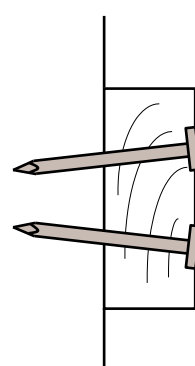

Malohi

Fa'o Sikalu

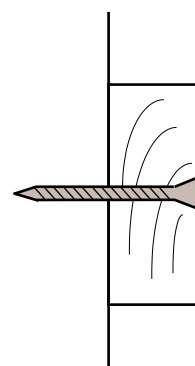

Hoko femapuniaki mo e fa'o

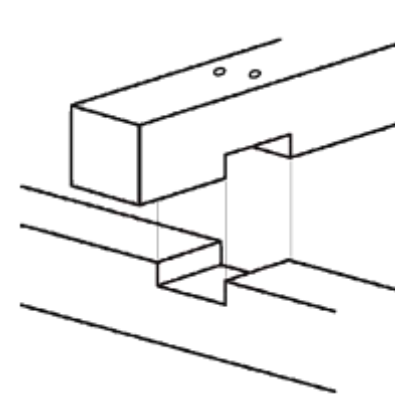

Malohi ange

Peleti papa'i

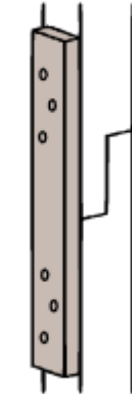

Polota

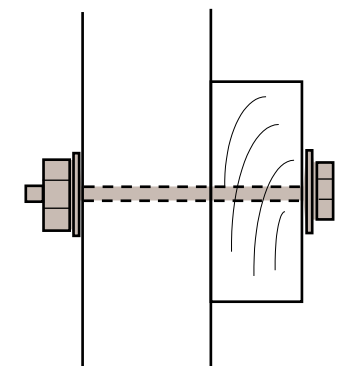

Malohi 'aupito

A a
 'Oku lelei ange ke nounou pe 'a e matatulutulu ke ta'ofi hono haea e 'ato mo loloa fe'unga ke malu'I e holisi mei he vai

45cm/
1.5 ft max

Fale lelei 'oku ne fiema'u e 'ato lelei

Koe founga ki hono fa'u mo langa hao 'atu, 'oku mahu'inga ke ne malu'I ko e mei he matangi mo e 'uha. Langa ho 'ato he fotunga totonu moe ma'olunga lelei mo tuki fakama'u ke ne malu'I mo matu'uaki e matangi

E 'Oku tokoni e ova e la'ikapa ke fakamalohi'I he ngaahi hoko

Femahiliaki

B Koe ma'olunga lelei ki he 'ato ko e 30°

15°
Fu'u felet i

30°
Malohi

50°
Fu'u fakahi hifi

3
2
1

1 2 3 4 5
5 across 3 up

C fakaputuputu e fa'o he tuki e 'aofi

2 ft | 2 ft | 2 ft | 1 ft

CGI thickness 0.4mm

D Ngaue'aki e fa'o 'oku 'I ai l eta pe koe silikoni 'ato

KOE HA E ME'A TEU NGAUE'AKI KE MALU'I 'AKI HOKU 'ATO?

KOE HA E FOTUNGA E 'ATO TEU NGAUE'AKI?

Fa'o angamaheni	Fa'o tataa	Uaea Siamane	Fa'o tataa ngaofe	Fa'o 'ato sukuluu
Fu'u Vaivai X	Malohi ✓	Malohi ✓	Malohi ange ✓✓	Malohi ange ✓✓

'Ato fakapalepale	'ato faha'I ua	Koe lahi ange ngaahi tahifo he 'ato 'oku ne fakasi'isi'I e faingamalie Ki hono haea e 'ato
Fu'u vaivai X	Malohi ✓	Malohi ange ✓✓

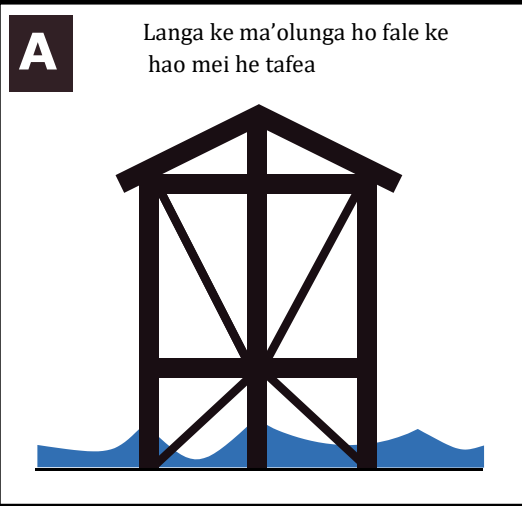

TU'U'ANGA 'O E FALE KE MALU



Fakapapau'I e ngaahi fakatu'utamaki 'I ho 'ataakai pea ke langa fakatatau ke ne matu'uaki e ngaahi fakatamaki koia.

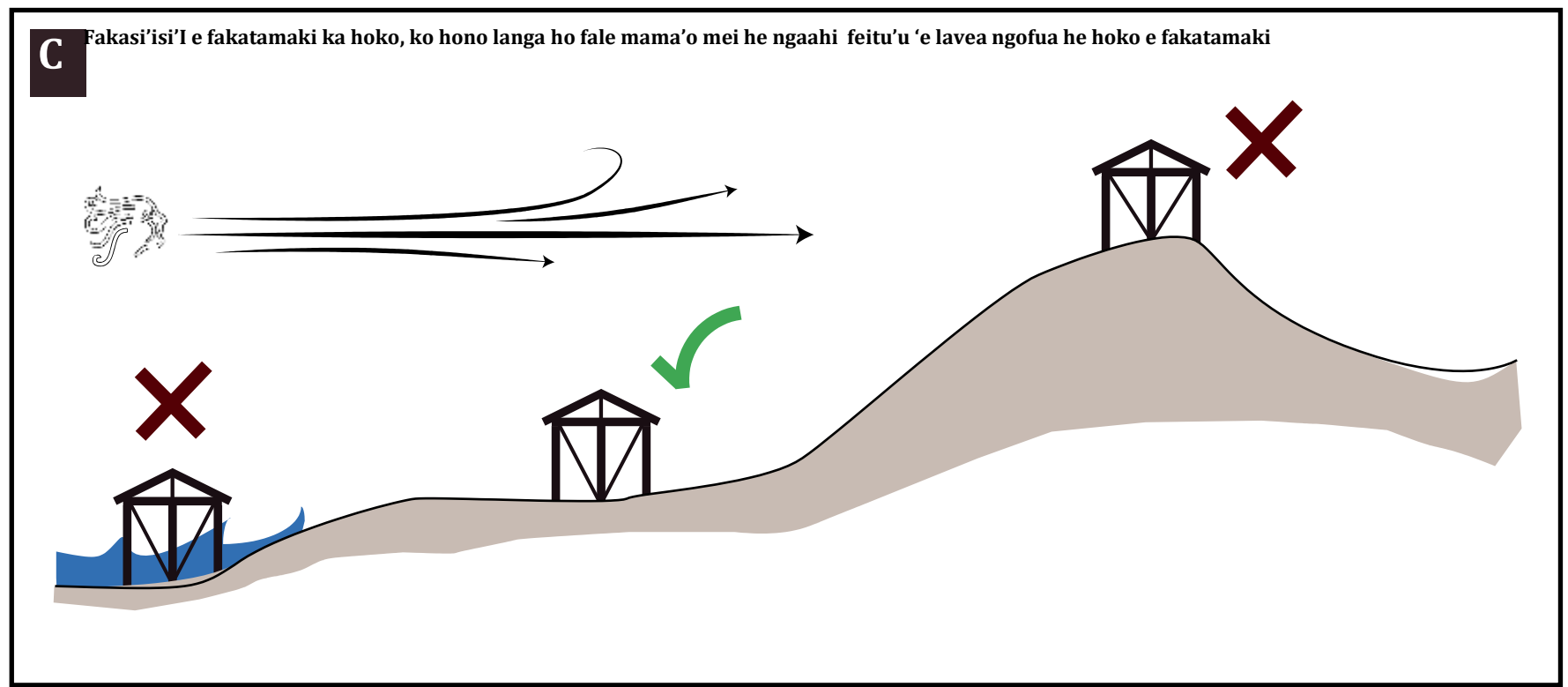
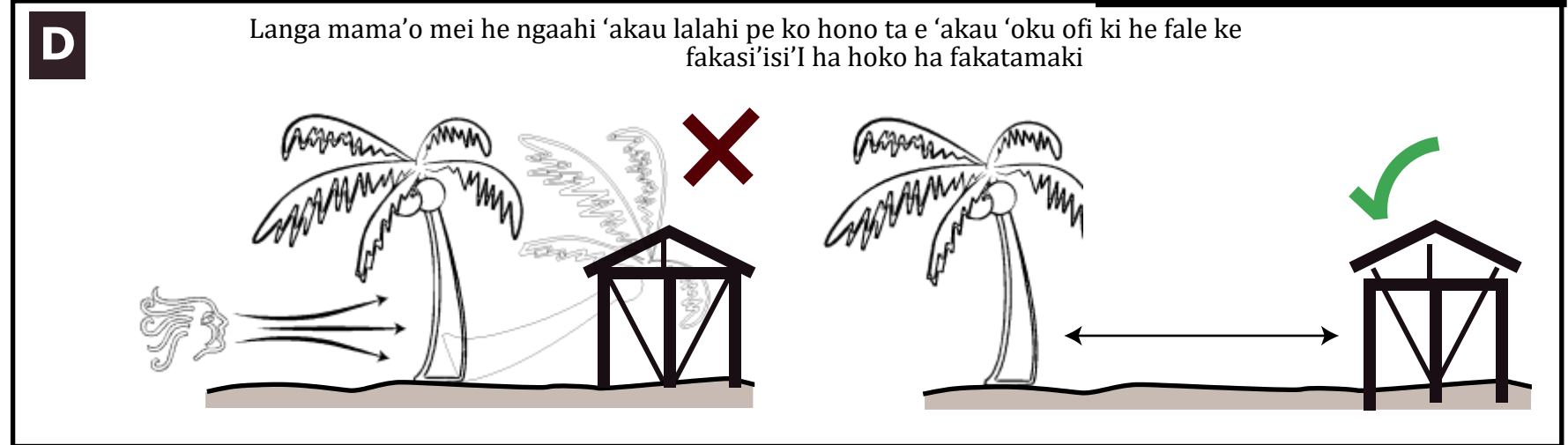
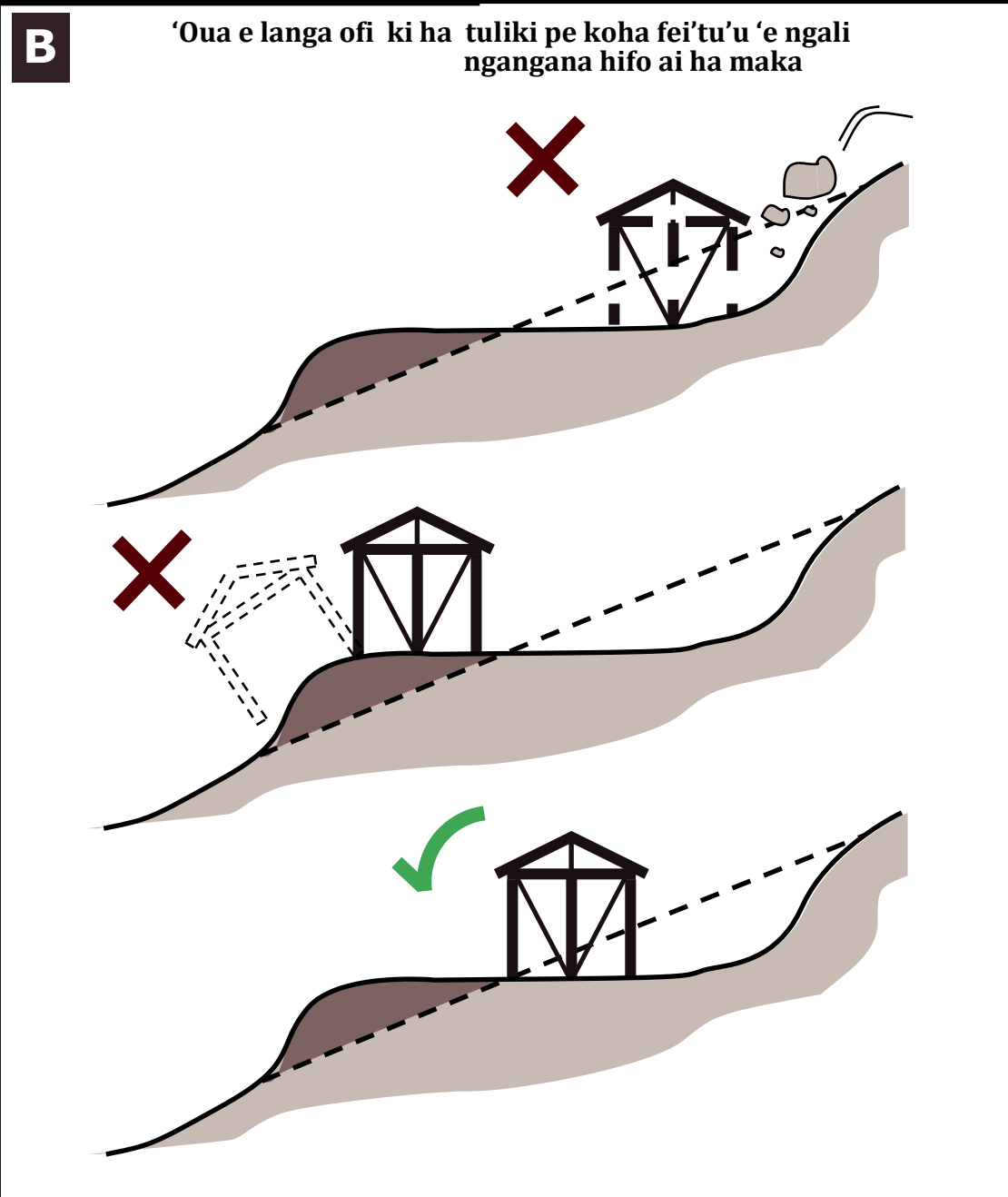

A Koe fakapalepale 'oku ne fakavaivai'I e malohinga ho fale

KO HA FOTUNGA FAINGOFUA TEKE MALU'I KOE KEKE HAO

TKo e fotunga 'oe fale 'oku mahu'inga 'aupito ke fakasi'isi'I hono mamau'I he matangi malohi. Koia ai palani 'I ho fale 'I he fotunga faingofua mo malohi

B otunga 'oku malu ange ia

Length no more than three times the width

C Don't extend too long

D Hoko e falee ke 'ato makehe pe mei he tefito'I ato e fale

'E angafefe ha'aku palani ha langa ha fale?

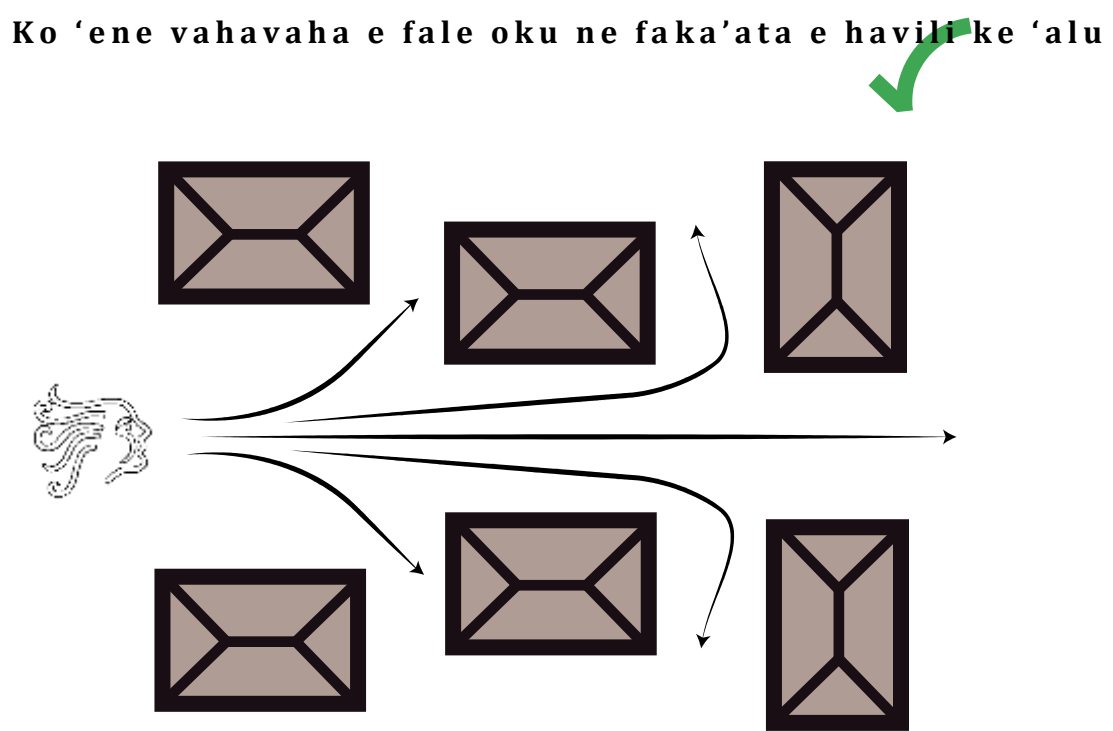
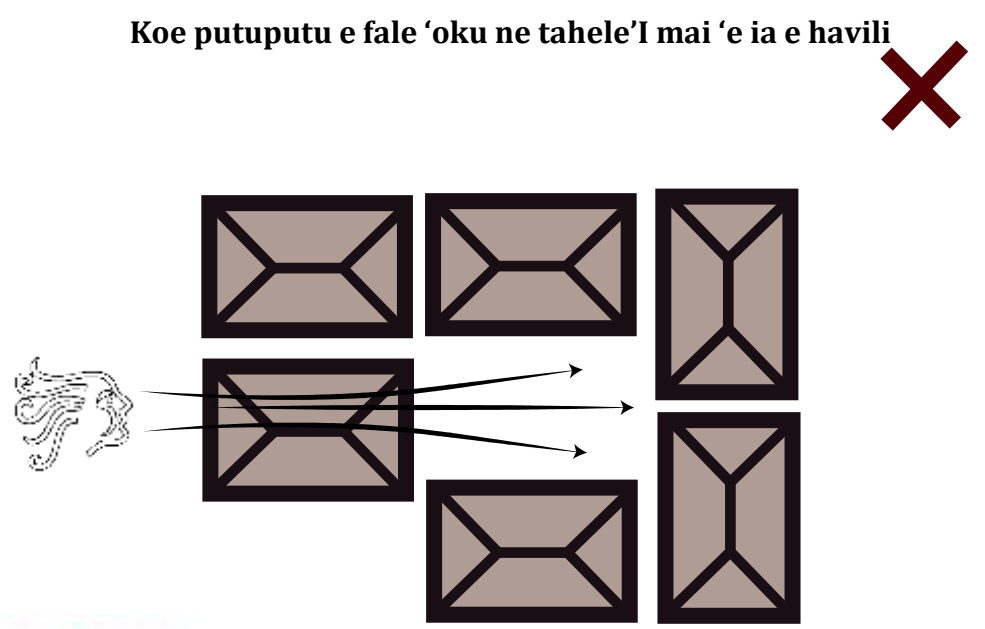

A Ko eha e ngaahi fakatamaki hoku atakai

Afaa Lahi?
Tafea?
Hake tahi ki he fonua
Tsunami?
Mofuike?
Holo ha konga fonua?
Puna ha mo'unga afi?



Mateuteu ma'u pe 'oku fu'u mahu'inga ia he koe me'a ia 'e lava ke fakasi'isi'I e uesia he matangi. Mahu'inga ke ngaue leva 'o teuteu he taimi ni..



C Ko eha e mea teu fai ki heku fale ka hoko ha fakatamaki?

Ha'I ki lalo e fale
Malu'I e matapa luva
Tuku e ngaahi me'amahu'inga kiha feitu'u ma'ama'alunga lolotonga e tafea
Fakapapau'I e ngaahi me'a 'oku ngahomohomo ke 'oua e puhi he havili
Tamate'I pe ta'aki mei he palaki e 'u me'angaue

B HILI HA NGAahi TAIMI KOE HA 'Eku ME'A TEU FAI KE MATEUTEU HOKU FALEE?

'Ai e Ha'i
'Ai e matapa ki he luva
To e ngaahi 'akau kene malu'I ho fale
Teuteu e loki malu mo malohi
Ta e ulu 'akau lalahi ku ofi ki he fale

'E angafefe ha'aku mateuteu mo e komiuniti ki ha fakatamaki 'e hoko?



Fa'u ha palani pea fakaangaanga
Fai Tu'utu'uni ke vave pe teke fetukutuku pet eke nofo pe 'I ho 'api
Mateuteu ke fetukutuku ha halanga 'oku malu
'Ilo feitu'u 'oku malu ke fai ki ai e fetukutuku
'Ilo koe ha e founga e fetukutuku teke ngaue'aki



'Ilo e fakatokanga matangi
'Ilo e founga teke ma'u ai e fakaikiiki e fakatamaki
Fakaha ki ho kainga moe kaungame'a e feitu'u teke fetukutuku kiai
'Ilo pe e anga fefe ho'o fetu'utaki moe kainga moe kaungame'a he hili e fakatamaki
'Ilo pe angafefe pea mohair teke fakaha ki 'ai e tu'unga 'oku ke 'I ai hili e fakatamaki
'Ilo e feitu'ut teke ma'u mei ai ha fakamatala fekau'aki mo ha tokotaha 'e mole



Teuteu ma'u pe ha milemila kimu'a 'I ha fakatamaki 'e hoko
Teuteu ma'u pe ha kato 'e faingofua ki hono to'oto'o fakakau kiai:
Naunau faito'o
Vala mo su 'oku malu , maka ki he kasa, masi, moe me'akai, naunau ke ngaahi 'aki e me'akai, ngaahi naunau angamaheni ngaahi leekoti mahu'inga/ ID
'Oua na'a ngalo e vai