

BAMBOO Foundation options

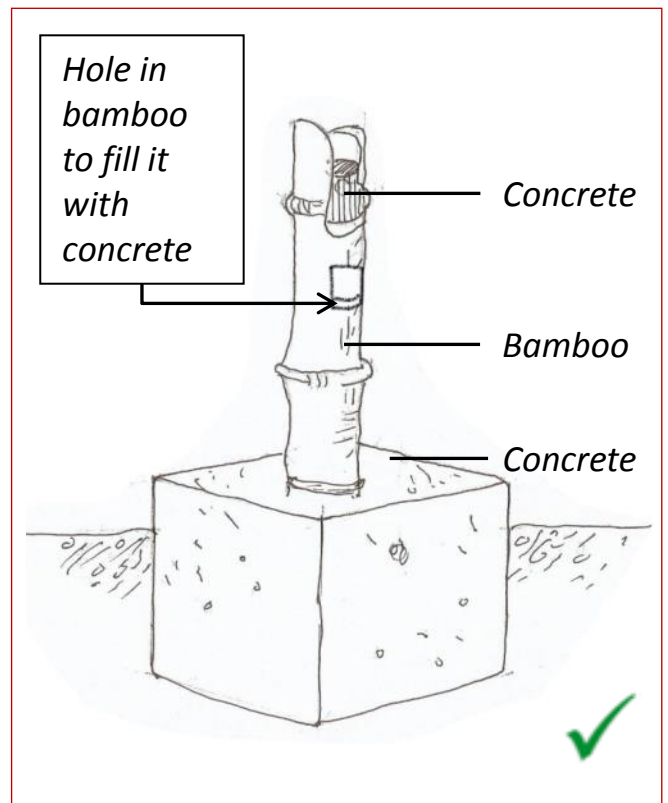

BAMBOO: key principles for using bamboo

Don't cut the last node, it weakens the bamboo!

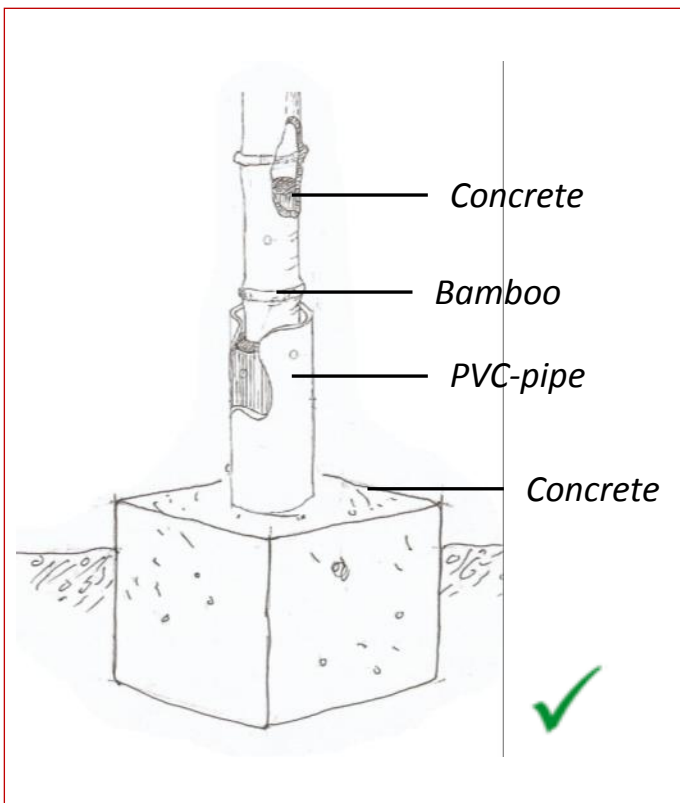
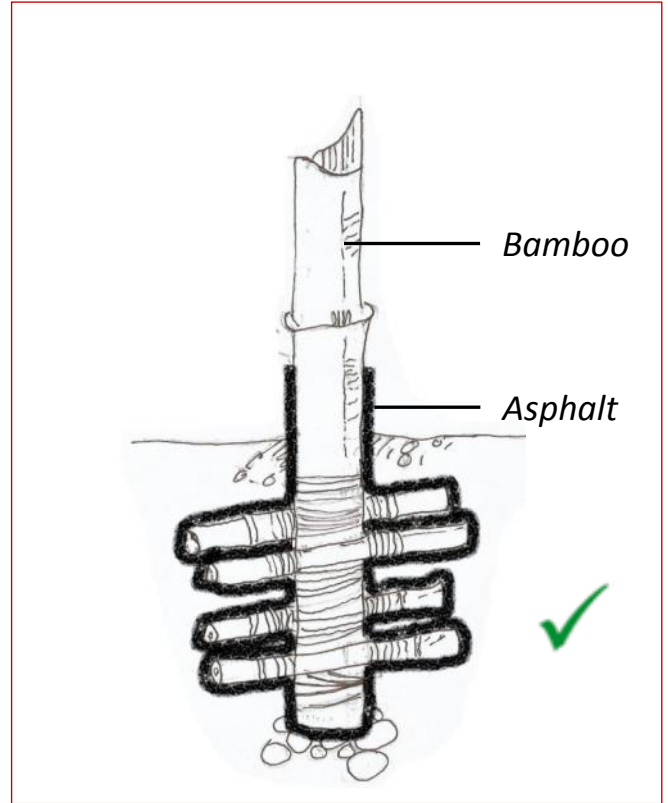
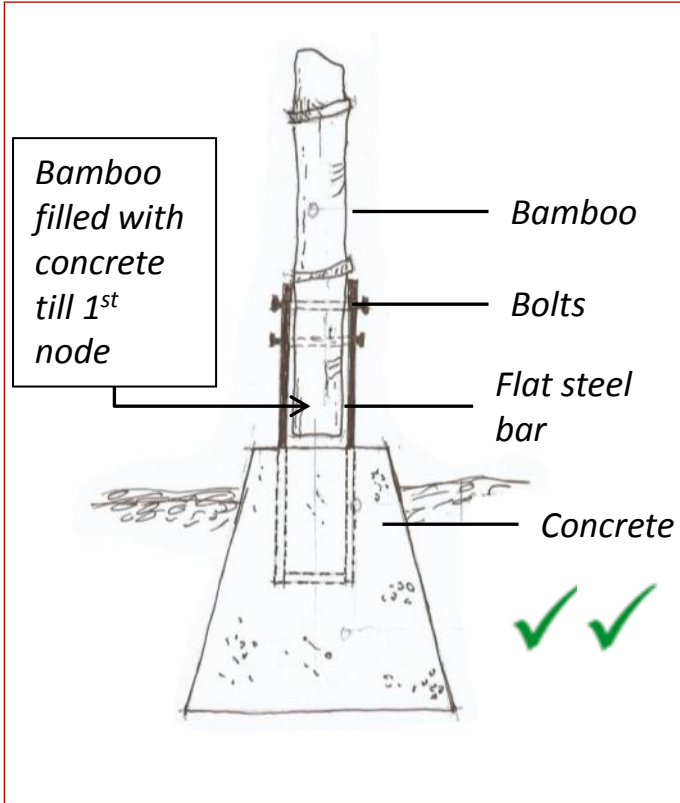
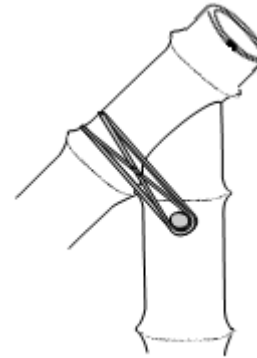
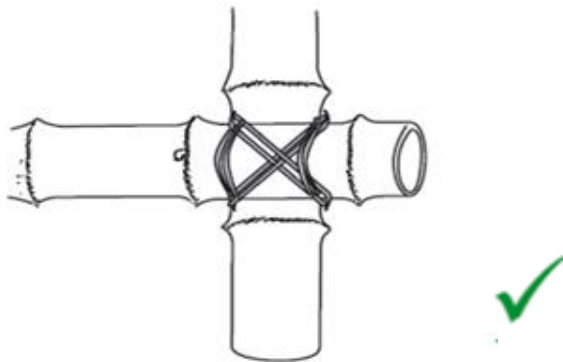
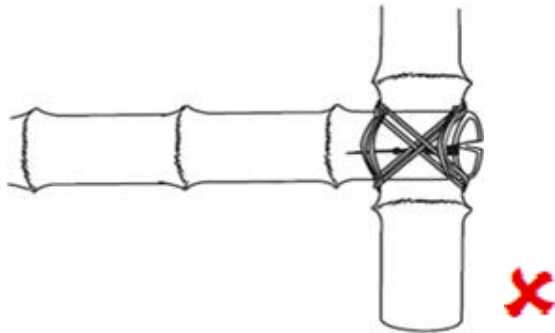

Cut the bamboo near the node.



If using nails, carve away the 'skin' of the bamboo to prevent cracking

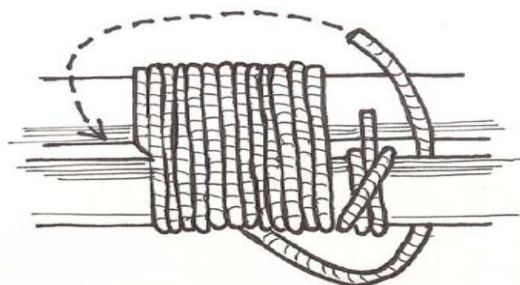

BAMBOO, options for Fixings & Bracings

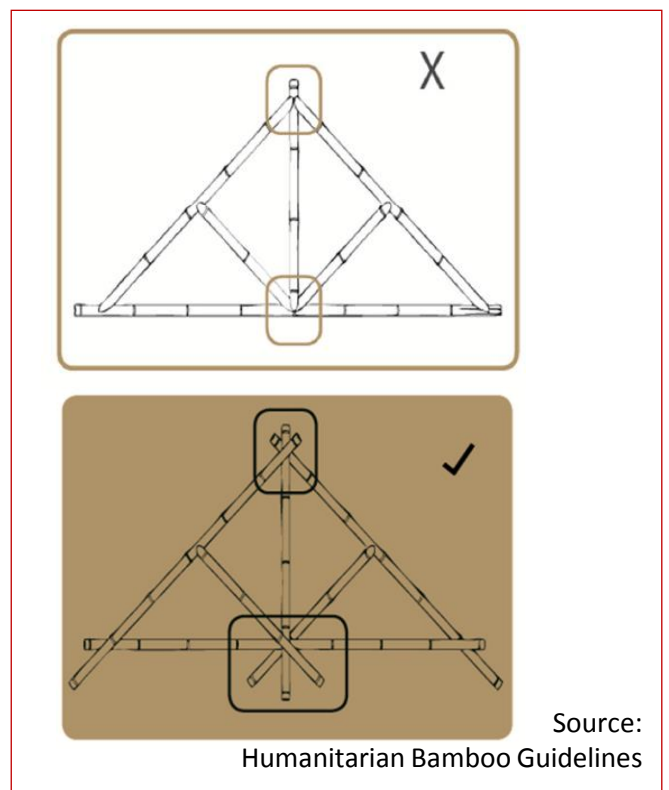
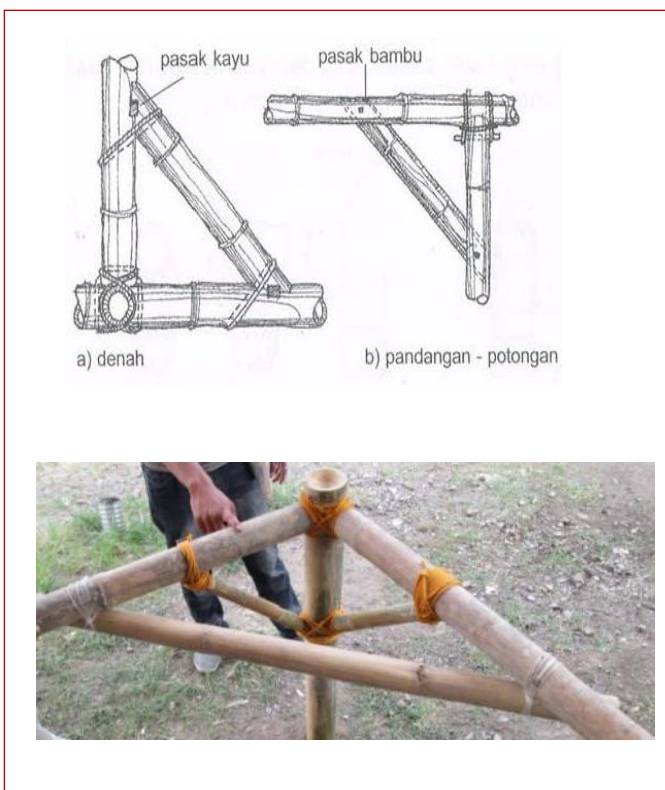
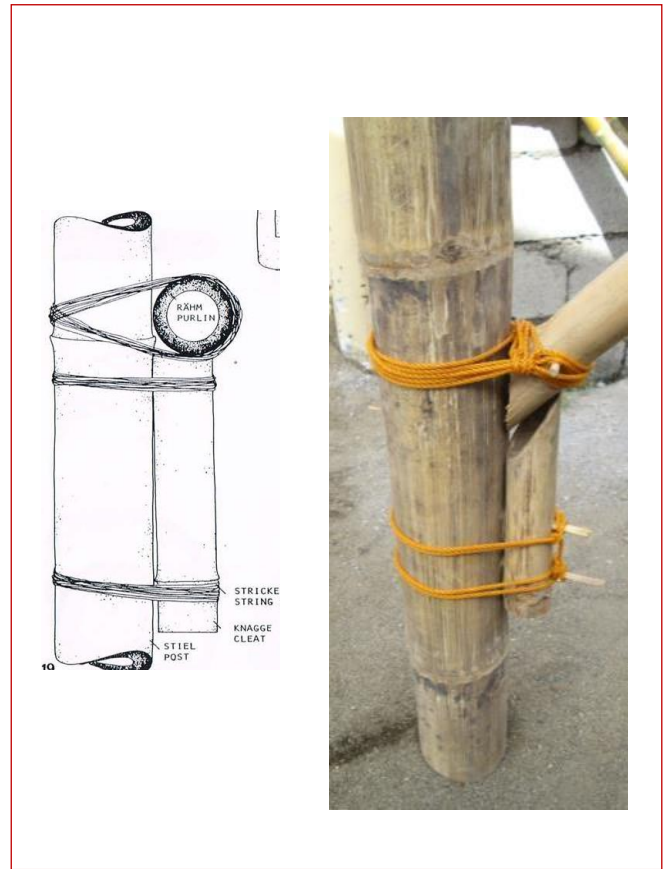
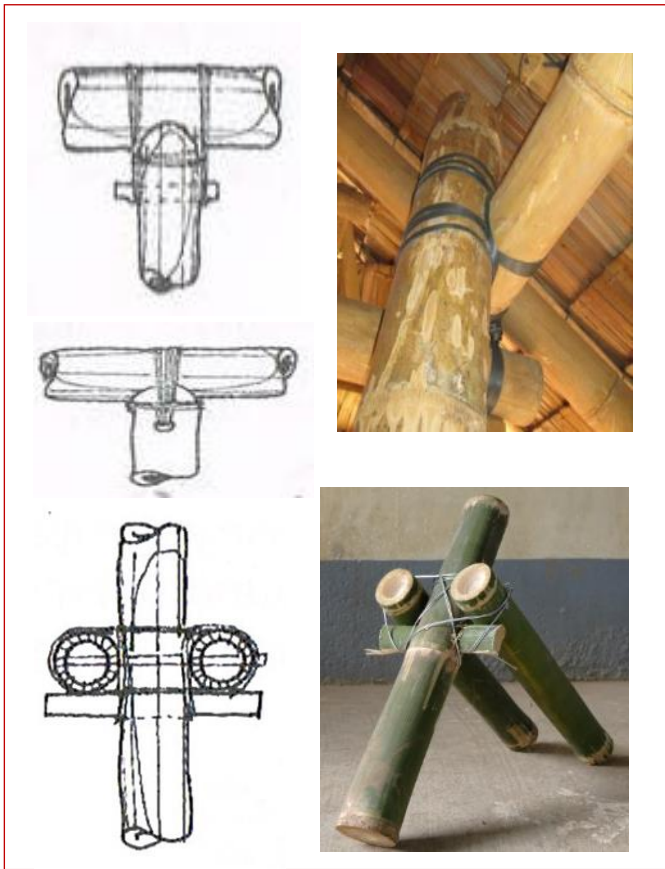

Source:
 Humanitarian Bamboo Guidelines