

# Build a Safe House with **CONFINED MASONRY**

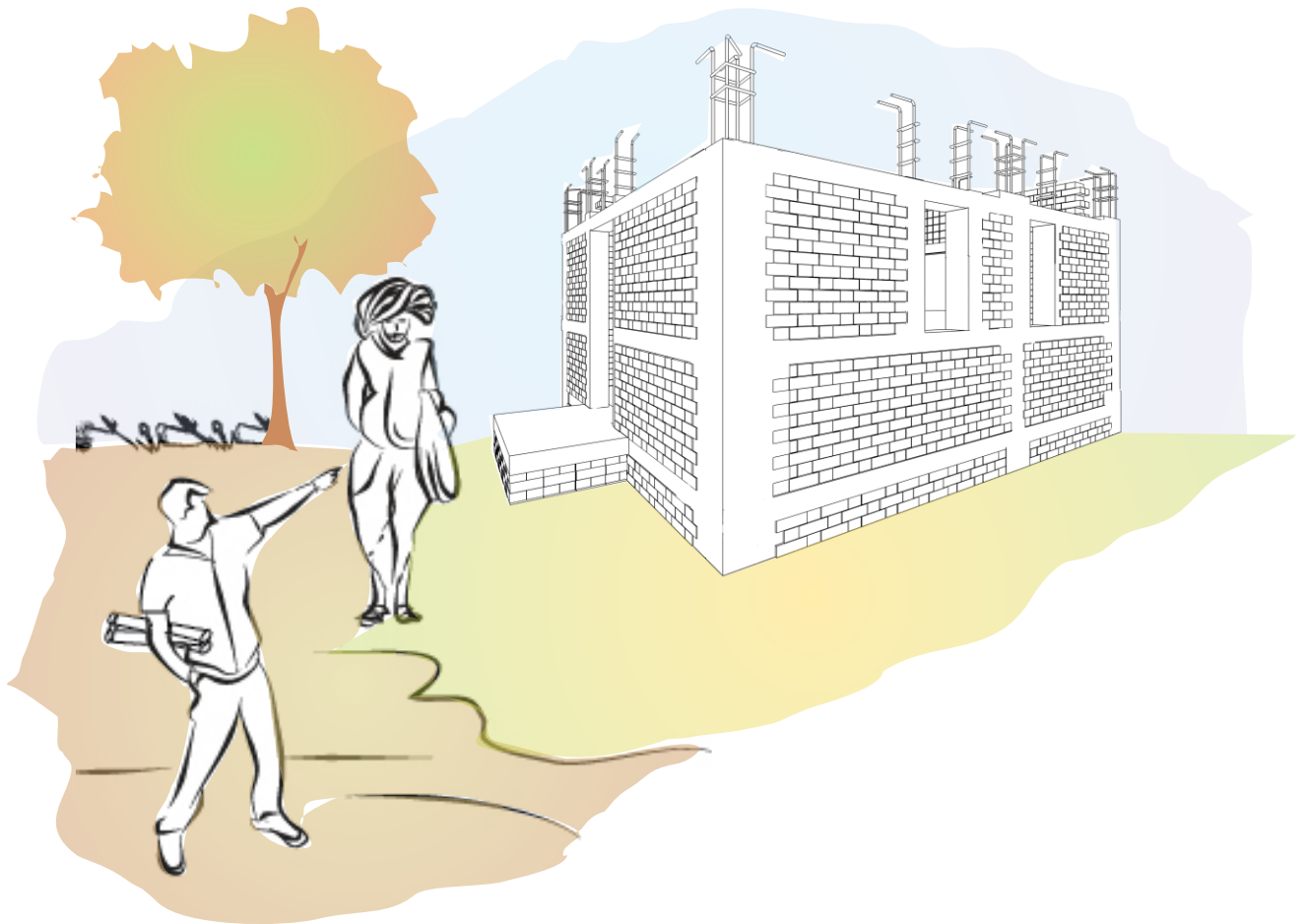

Kamu Iyer  
Shibani M. Kulkarni  
Shantanu Subramaniam

C. V. R. Murty  
Rupen Goswami  
A. R. Vijayanarayanan



**Gujarat State Disaster Management Authority**  
Government of Gujarat



# Build a Safe House with CONFINED MASONRY

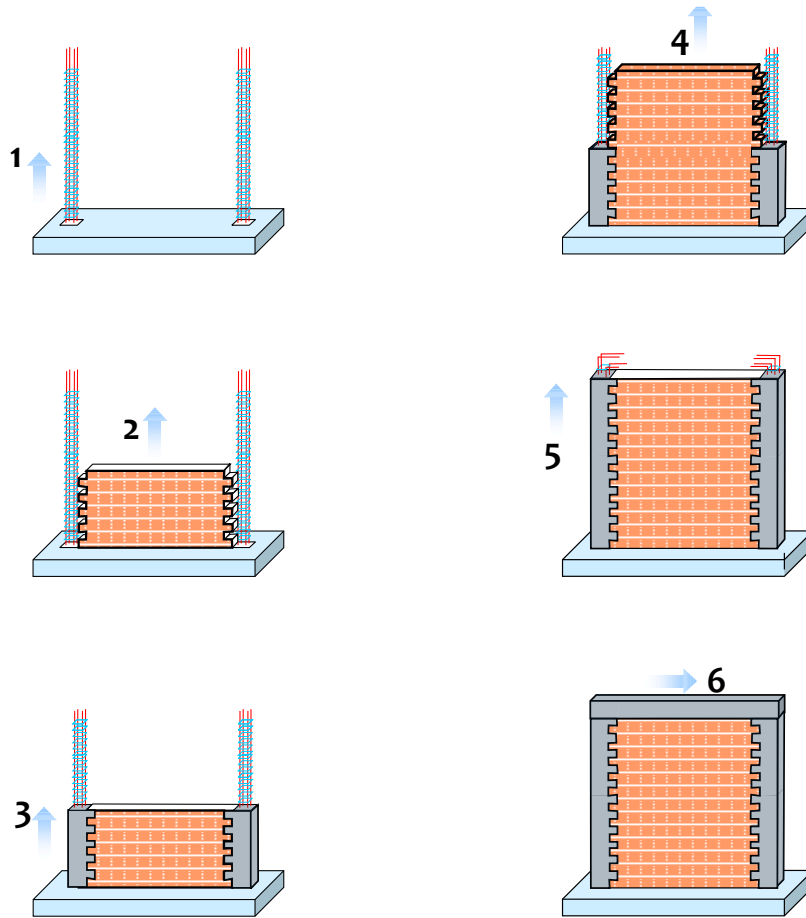

Kamu Iyer  
Shibani M. Kulkarni  
Shantanu Subramaniam

C. V. R. Murty  
Rupen Goswami  
A. R. Vijayanarayanan



**Gujarat State Disaster Management Authority**  
Government of Gujarat



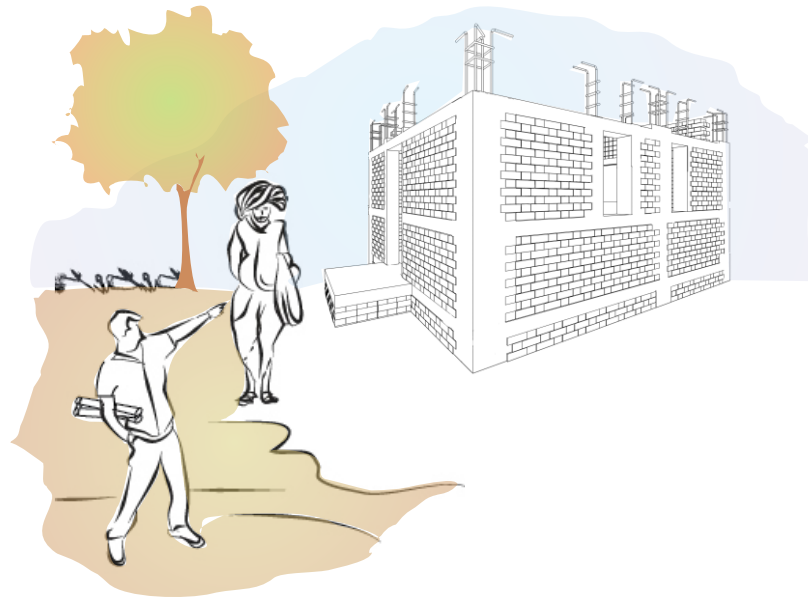

## Contents

<i>Preamble</i>	1
<i>Acknowledgment</i>	5
<b>Confined Masonry</b>	7
<b>Options for a Confined Masonry House</b>	15
<b>Basics of Construction</b>	79
<b>Construction of House Option 1</b>	99



## Preamble

Most houses in rural India are masonry houses. The masonry walls are built with burnt clay brick or natural stone masonry. Many choices are made across India for the roof. For instance, a sloping roof with wood truss and burnt clay tile is adopted in Kachchh region of Gujarat (western state of India), and a flat roof with reinforced concrete (RC) slab in Tehri Region of Uttarakhand (northern state of India). These houses are constructed in the *conventional* manner known to masons. Technically, they are called **Unreinforced Masonry (URM) Houses**; it has plain masonry walls with no steel reinforcement embedded in them to improve their behaviour during earthquakes. Today, of the existing building stock in India, about 45% of houses are made of burnt clay brick and about 10% of natural stone. Thus, over half of India's population lives in URM houses.



**A village house**  
with unreinforced masonry

Unreinforced masonry (URM) walls are pushed sideways during a strong earthquake, along their length and thickness directions. When shaken along their thickness, they collapse. And, when shaken along their length, they develop diagonal cracks along their length and/or separate at wall junctions. When walls collapse, they bring down the roof along with them. This is the main reason for large loss of lives during earthquakes that have occurred in different regions of the country.

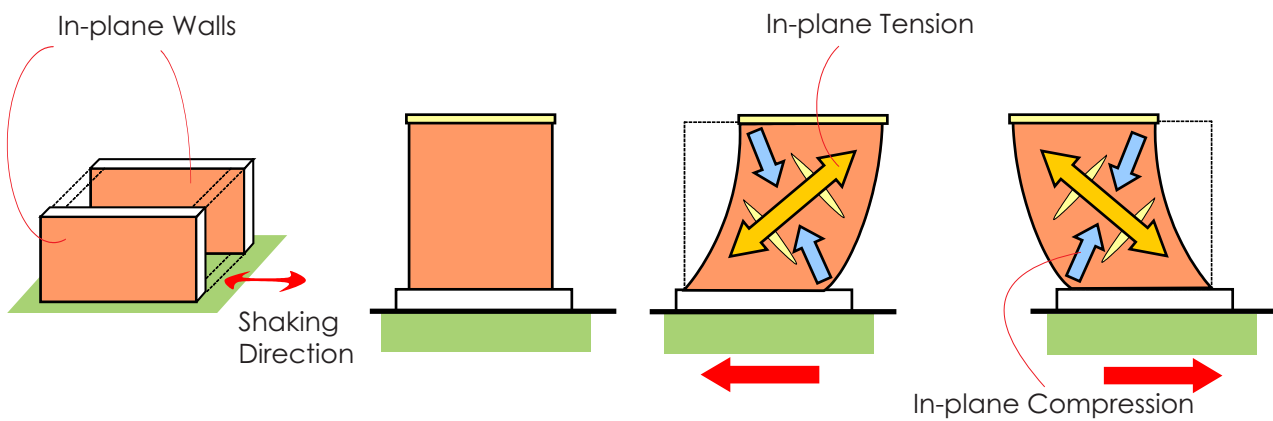

**Shaking along length direction of masonry wall results in diagonal cracking**

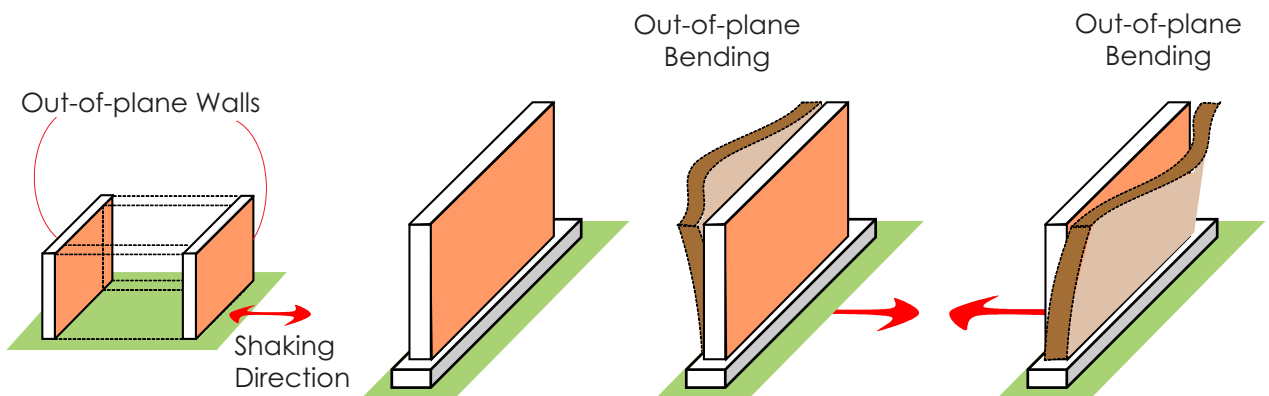

**Shaking along thickness direction of masonry wall can result in collapse**

Despite houses collapsing in earthquakes, people still continue to reconstruct their houses in the age old method of unreinforced masonry, thereby making their houses vulnerable to future earthquakes.



**A villager rebuilding his house**  
with unreinforced masonry

In cities, RC buildings are constructed first by making the RC frame, and then by infilling the spaces between beams and columns with masonry walls made of burnt clay bricks or cement blocks, and cement mortar. To build a house this way requires high levels of technical skills, which usually are not available in small towns and villages. But, everyone, whether residing in a town or a village, wants a **pucca** house - a house with brick walls and RC roof, just like the buildings in larger towns and cities. This is reason enough to improve earthquake safety measures in these houses.



**An RC frame building**  
commonly built in cities

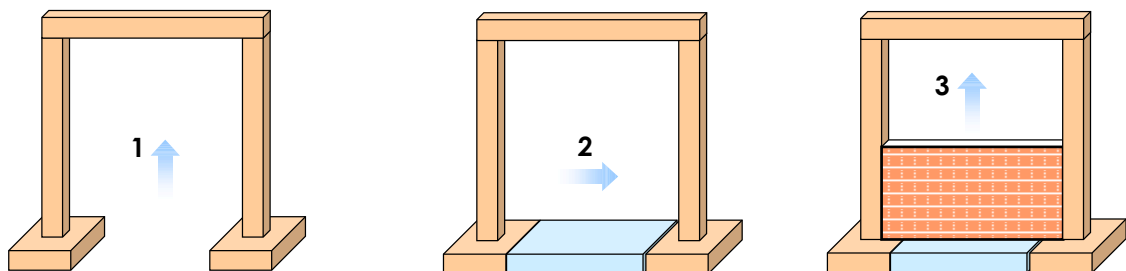

Sequence of  
**RC frame construction with URM infill walls**

Small, but significant, changes should be made in current method of construction of masonry houses in rural India. This improved method of house construction is called **Confined Masonry Construction**. Loss of life can be reduced considerably in masonry houses during future earthquakes. For this, masonry walls are confined on all four sides with (a) stiffer and stronger vertical elements made in RC, and (b) RC horizontal bands at discrete levels in the masonry walls along the perimeter of all the rooms of the house.



**Confined Masonry House**  
with clay brick walls and RC slab

Books providing technical information on confined masonry construction are exhaustive, but largely offer generic details. They have to be adapted for specific conditions at site. Often, this is difficult for a man building his house. An illustrated manual such as this is required, that follows the requirements of Confined Masonry Construction in an easy-to-follow language, and provides guidance on how to build a confined masonry house with specific functional design. Such a manual will enable the individual house owner or a 'practical technician' to build such a house. Also, the manual will help local authorities to construct houses under any social housing scheme sponsored by the Governments.

This book illustrates the step-by-step construction of a *Confined Masonry House* of a specific design. It provides precautions to be taken and amount of material required to construct the house. Also, alternate specific designs are presented.

## Acknowledgements

The authors are grateful to the Gujarat State Disaster Management Authority (GSDMA), Government of Gujarat, Gandhinagar (Gujarat, India), for readily agreeing to support the preparation of this book; the generous financial grant provided by GSDMA towards this effort is gratefully acknowledged. The authors also extend their appreciation to Dr. R. Bannerji, IAS, Chief Executive Officer-GSDMA, Dr. V. Thiruppugazh, IAS, Additional Chief Executive Officer, GSDMA and Mr. S. I. Patel, Additional Chief Executive Officer, GSDMA for their invaluable inputs and guidance during the course of preparing and finalizing this book. Ms. Alpa R. Sheth, Managing Director, Vakil Mehta Sheth Consulting Engineers Private Limited, Mumbai, and Seismic Advisor, GSDMA, Gandhinagar, Gujarat, supported idea of developing this book, and guided us throughout the course of this project from discussing the contents, mid-course feedback on the contents, to getting the book reviewed. The authors sincerely thank Mr. Birju Patel, Deputy Director, GSDMA, Gandhinagar, for providing necessary details of government-driven social housing schemes being undertaken in Gujarat, and for the administrative support from GSDMA .

Dr. Svetlana N. Brzev, British Columbia Institute of Technology, Vancouver, CANADA, readily agreed to review the early manuscript and provided valuable comments for improving the quality of the publication. The authors are grateful to her for this special contribution. Ms. Betsy Ponnachan, III Year B.Tech. (Civil Engineering) Student of MNIT, Jaipur, played a pivotal role in bringing the document to publishable standards by significantly simplifying many graphics presented in this document; this special contribution is gratefully acknowledged. The authors acknowledge with thanks the support offered by various sections of IIT Madras in administering this book writing project. In particular, the authors gratefully acknowledge support offered by Mrs.S.Kavita, Project Assistant, Department of Civil Engineering, and of Mrs.C.Sankari and Mr.Anand Raj of the Structural Engineering Laboratory of the Institute.

The authors remain indebted to their family members for the unconditional support and understanding throughout the of development of the book... This book is dedicated to all the people of India, who lost their kith and kin in masonry house collapses during past earthquakes in the country...





# **Confined Masonry**



## What will happen to my house in an earthquake, If masonry is not confined?

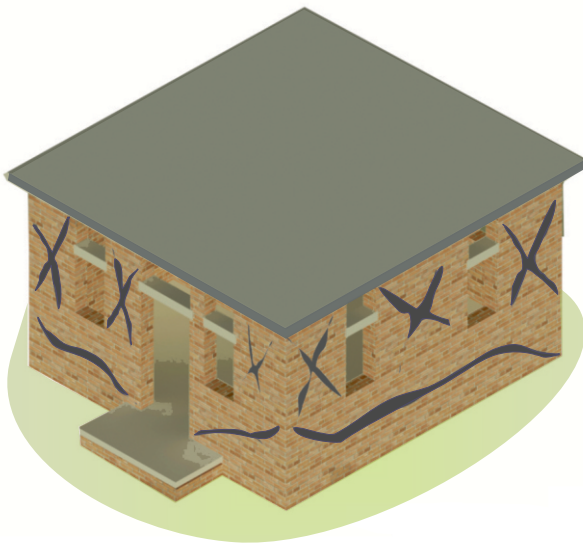

**Moderate Shaking**  
Walls Crack

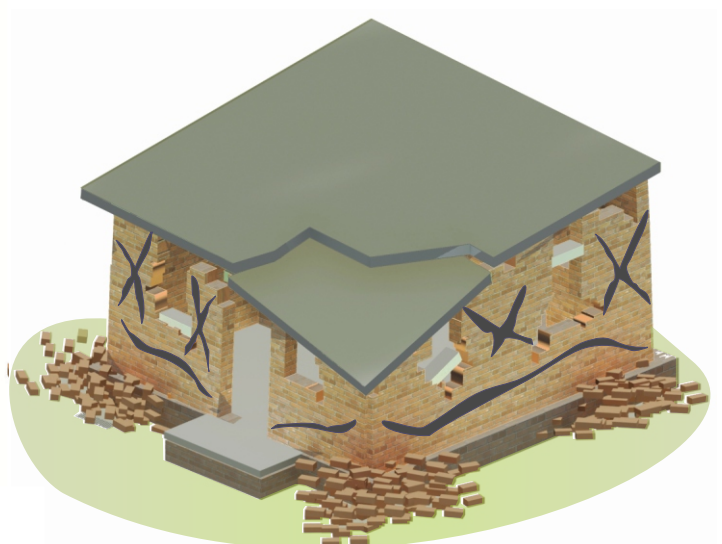

**Severe Shaking**  
Walls collapse and slab falls

During an earthquake, when the ground shakes moderately, unconfined walls are pushed sideways and therefore develop cracks. When the ground shakes violently, unconfined masonry walls collapse bringing down the roof, either partly or fully.

## How do I prevent this?

By confining masonry walls of the house. This is achieved by using:

- (a) vertical RC elements interlocked with bricks at all wall junctions and door and window openings, and
- (b) horizontal RC bands at plinth, sill and lintel levels.

Masonry confined thus is resistant to earthquakes.

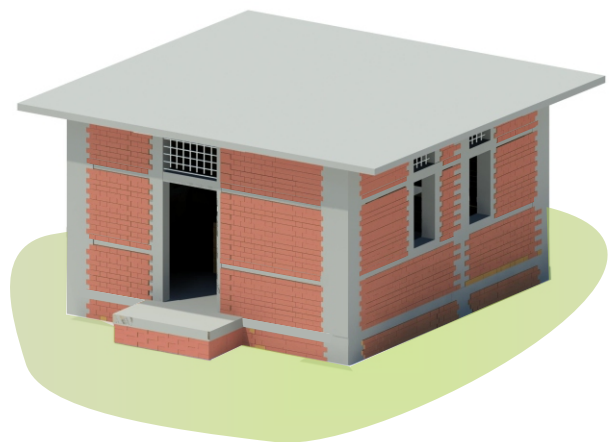

## What is Confined Masonry ?

Confined masonry (CM) consists of RC confining vertical and horizontal confining elements that are cast in-situ around URM wall segments built in small heights. Concrete in these RC elements is poured after the walls are made. This in-situ concrete fills all gaps and covers vertical bars protruding out from the foundation. On hardening of concrete, the RC elements hold the masonry wall segments snugly without any gap between them. This snug action is created by the tothing left in the masonry walls at wall corners and junctions, and adjoining door, window and ventilator openings.

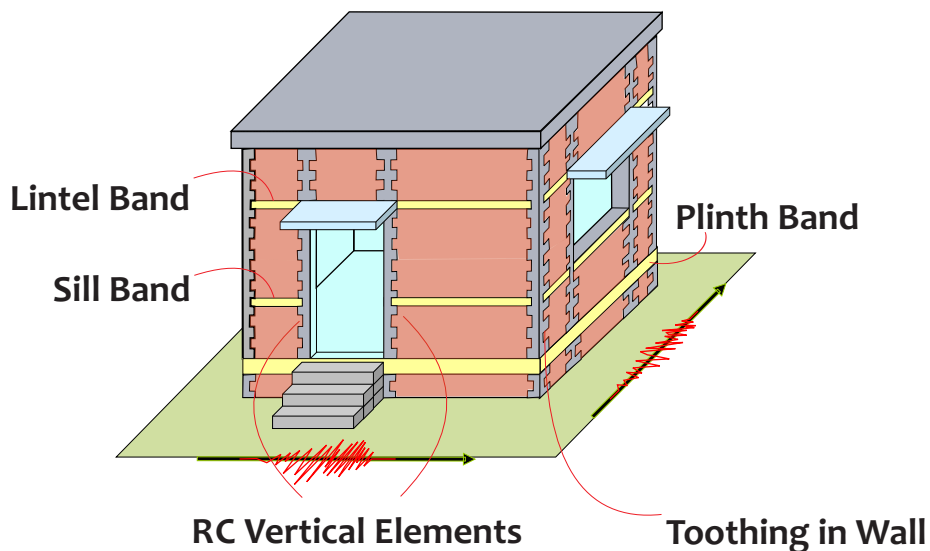

Small-sized vertical reinforced concrete (RC) confining elements are cast in-situ at all wall junctions and adjoining all openings. Horizontal RC elements (called bands) are cast in-situ above and below all openings and at floor levels. Normally, Plinth, Sill and Lintel Bands are provided; in buildings with pitched roofs, two more bands are provided, namely the Roof and Gable Bands. Longitudinal reinforcement bars in vertical RC elements are anchored into the plinth masonry at the bottom and roof slab (when roof is flat), or into the roof band (when the roof is pitched) at the top. Longitudinal reinforcement bars in horizontal RC bands run through all walls of the house; sill band alone is discontinued at door openings.

Under earthquake shaking, the loads are carried primarily by the composite system of masonry wall and RC elements through load-bearing action. These RC confining elements are small in size and grip the whole width of the wall at door and window openings and wall junctions. They have sufficient stiffness to resist to dilation of masonry wall that otherwise happens during earthquake shaking. Thus, each wall panel bound by the confining RC elements stays as an integral unit without disintegrating into its constituent materials.

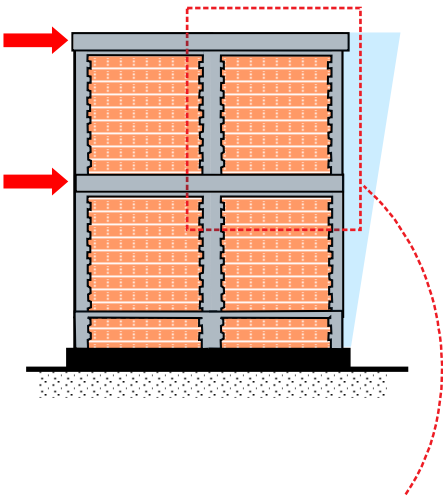

Only nominal bending in RC vertical and horizontal elements

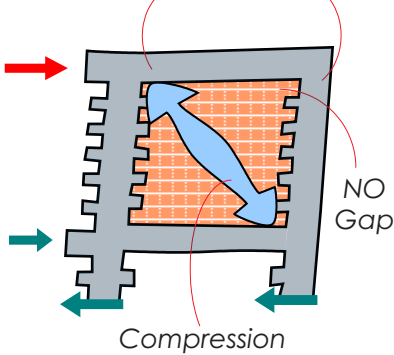

**RC elements holds masonry walls snugly**  
during earthquake shaking

Confined masonry is most suitable and practical method for construction of houses by individual home owners in earthquake areas. The level of engineering required is embedded in empirical rules for planning, design and construction of these houses. Two prominent features of confined masonry construction are:

- (1) Use of a regular grid of walls in both directions with RC vertical members at all wall junctions and in straight walls of longer lengths, and RC vertical elements (toothed into the masonry wall segments) and RC horizontal bands (resting on the masonry walls of the whole house). These items together confine the wall segments and prevent them from dilating along the length direction of the wall and from falling out-of-plane along the thickness direction of the wall..
- (2) Sequence of first making the masonry walls and then pouring in-situ the RC vertical elements and horizontal bands. This choice of construction sequence is responsible for enhancing the integrity of the masonry units and mortar in Confined Masonry, which in turn makes Confined Masonry Construction superior to regular RC frame buildings with plain masonry walls as infills.

Earthquake performance is good of confined masonry construction. While confined masonry constructions sustained severe damage during past earthquakes, complete collapse has not been observed in this typology of construction.

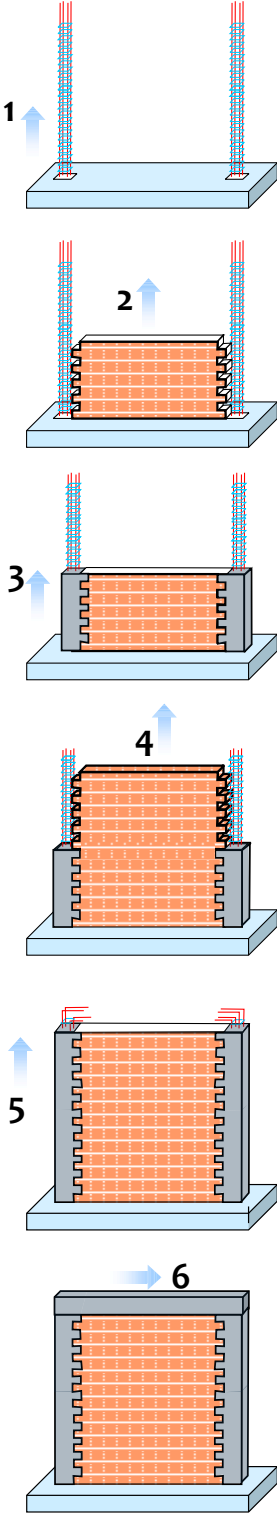

Sequence of Confined Masonry Construction

## What are the main elements of a Confined Masonry House ?

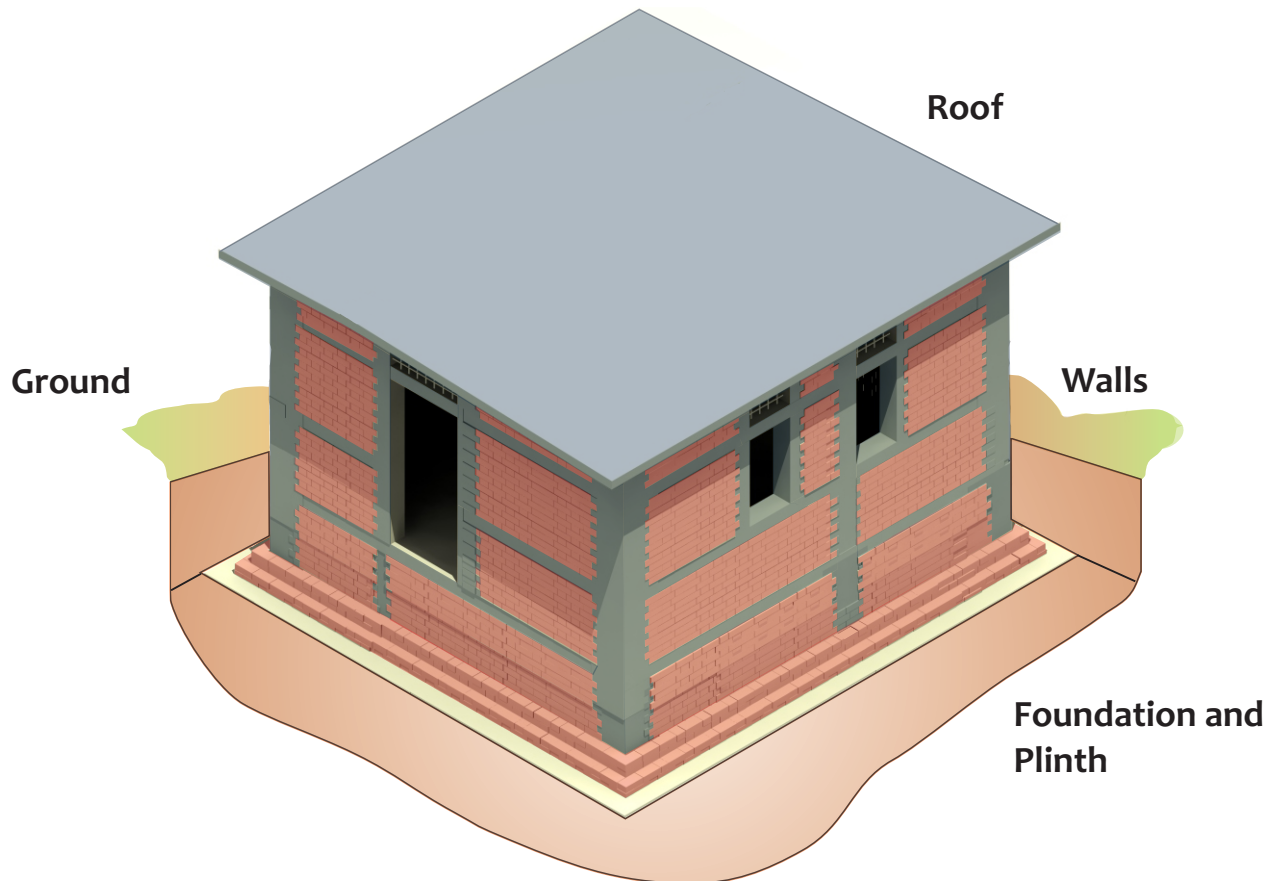

### **Foundation**

All elements of construction from soil level to ground level

### **Plinth**

All elements of construction from ground level to floor level

### **Wall**

Masonry wall, vertical RC elements and horizontal RC bands

### **Roof**

RC slab with all finishes on it in a flat roof, wood/steel truss, clay tiles/sheeting and all finishes on it in a pitched roof

### **Confining Elements**

Vertical RC elements, Horizontal RC bands at plinth, sill and lintel levels in a house with flat roof, and RC eaves and gable bands in a house with pitched roof



# **Options of Confined Masonry Houses**



# What are the available options ?

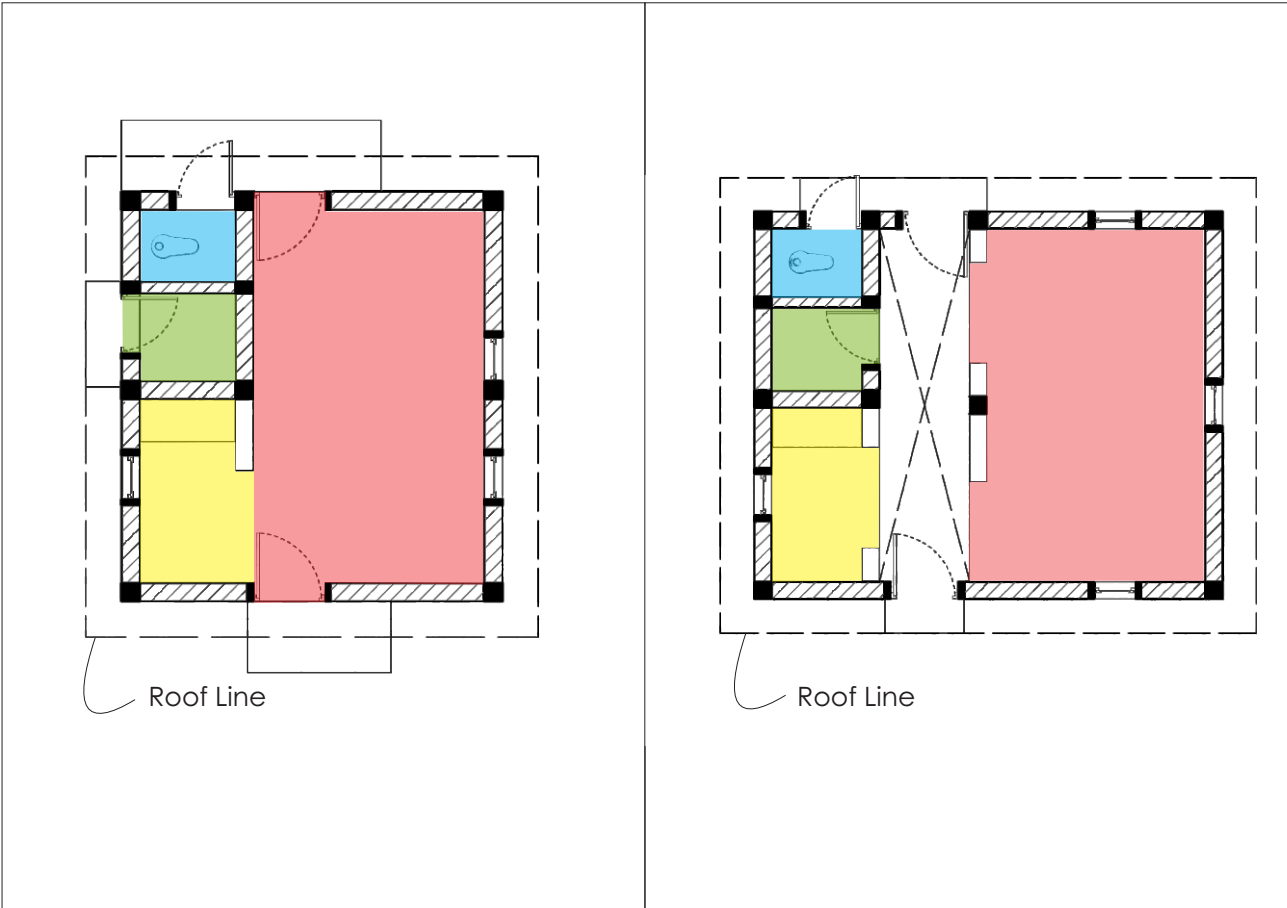

### Option 1

Built-up area: 24.67 m<sup>2</sup>  
 Carpet area: 18.78 m<sup>2</sup>

### Option 2

Built-up area: 32.03 m<sup>2</sup>  
 Carpet area: 20.18 m<sup>2</sup>

- Main Room**
- Toilet**
- Bath**

- Kitchen**
- Access Road**

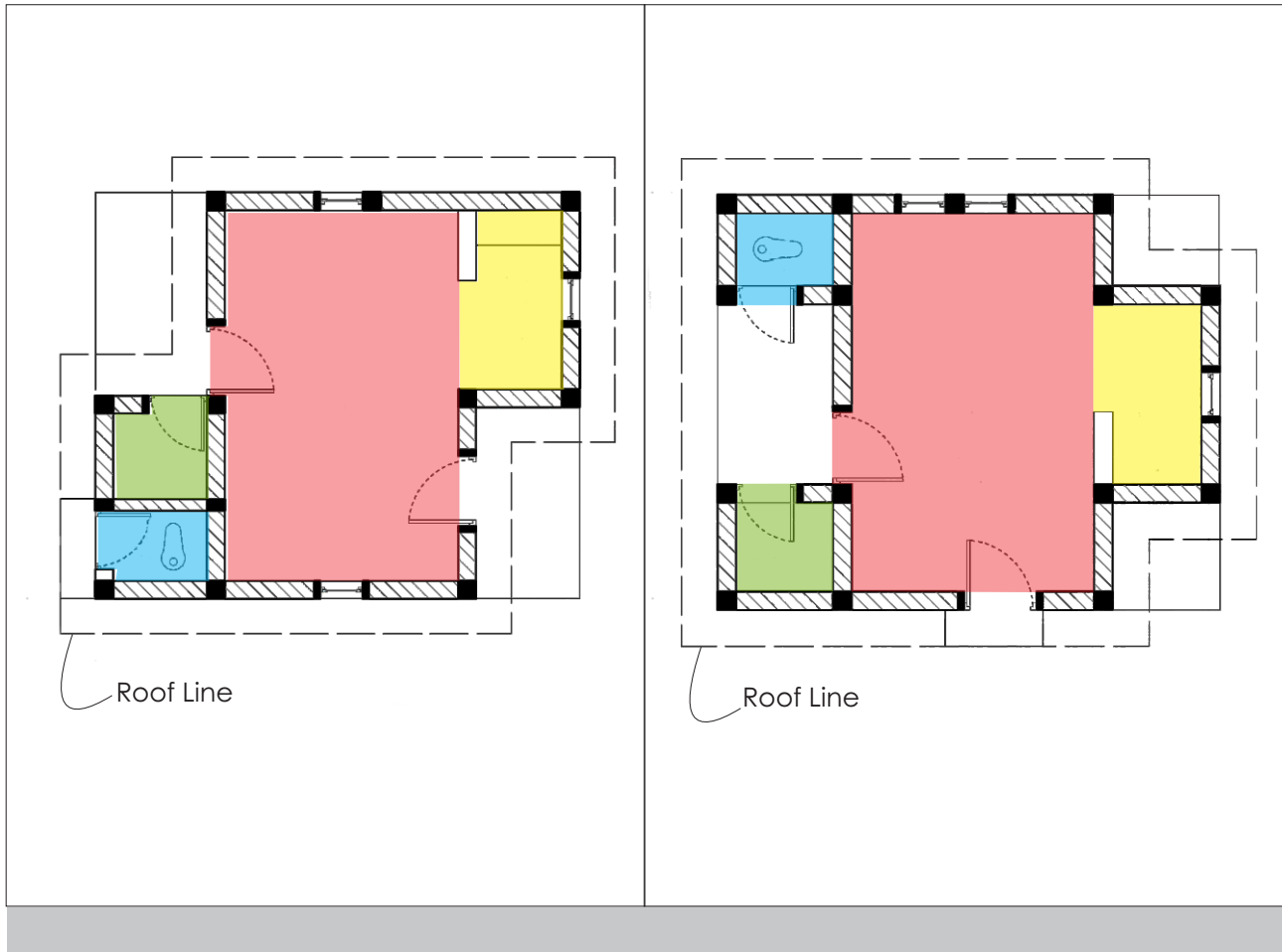

**Option 3**

Built-up area: 25.54 m<sup>2</sup>  
 Carpet area: 18.60 m<sup>2</sup>

**Option 4**

Built-up area: 32.47 m<sup>2</sup>  
 Carpet area: 19.21 m<sup>2</sup>

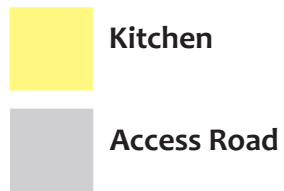
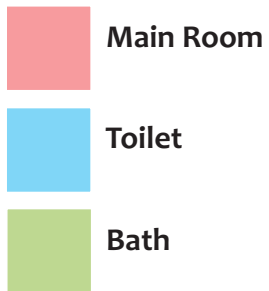

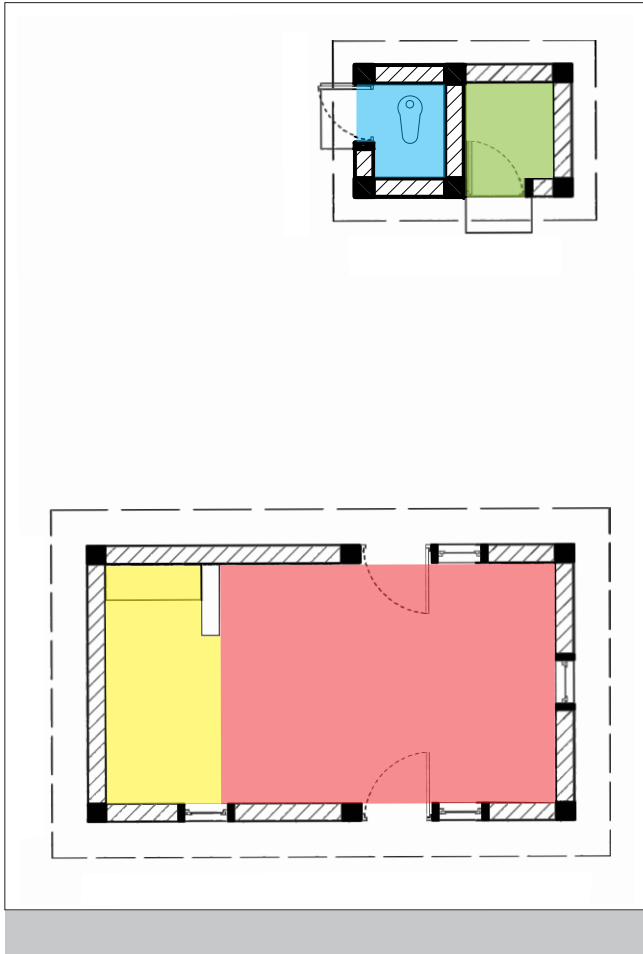

### Option 5

Built-up area: 30.53 m<sup>2</sup>

Carpet area: 18.92 m<sup>2</sup>



**Main Room**



**Toilet**



**Bath**



**Kitchen**



**Access Road**

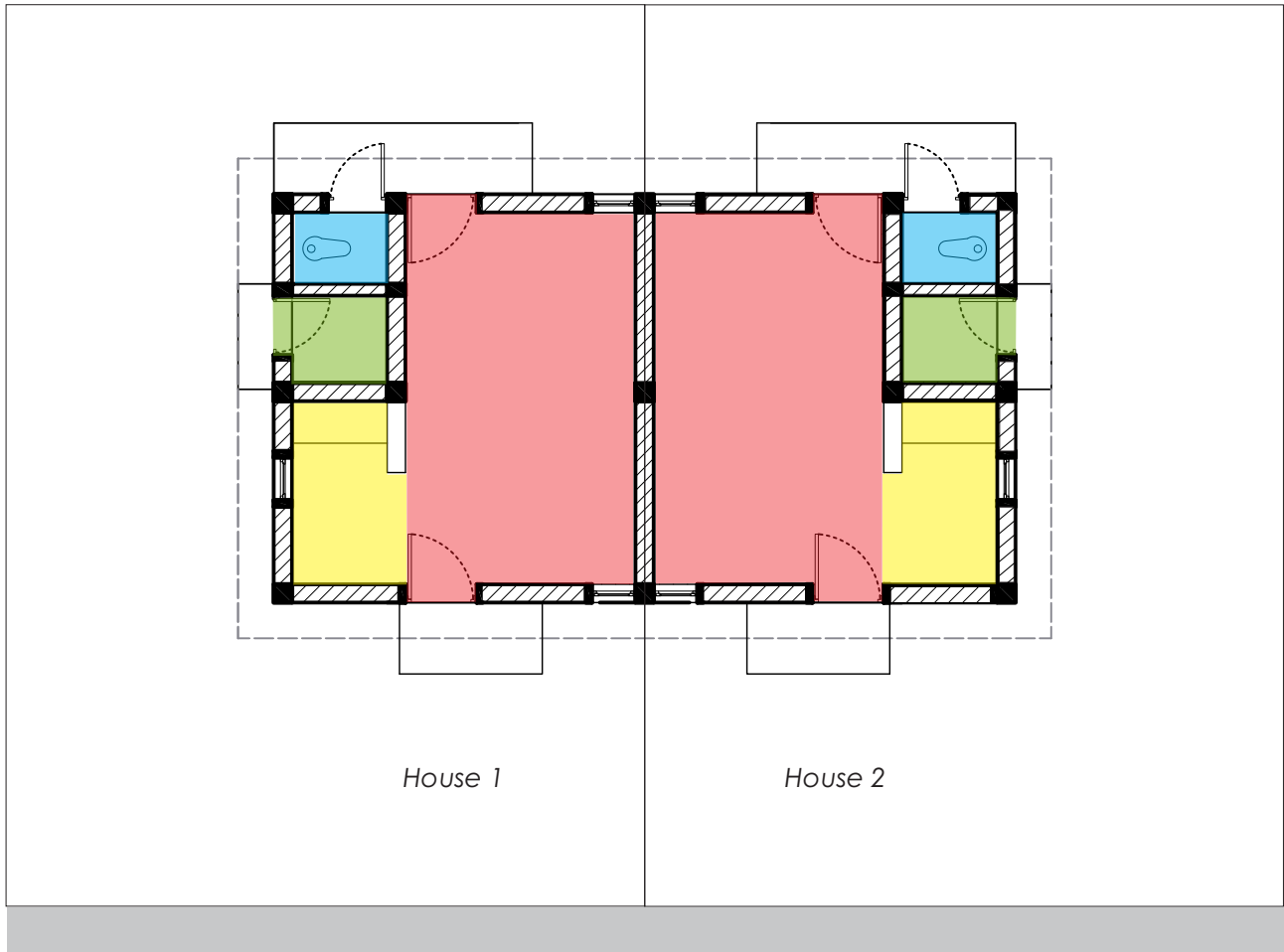

### Option 6

Built-up area: 24.67 m<sup>2</sup> each house

Carpet area: 18.78 m<sup>2</sup> each house



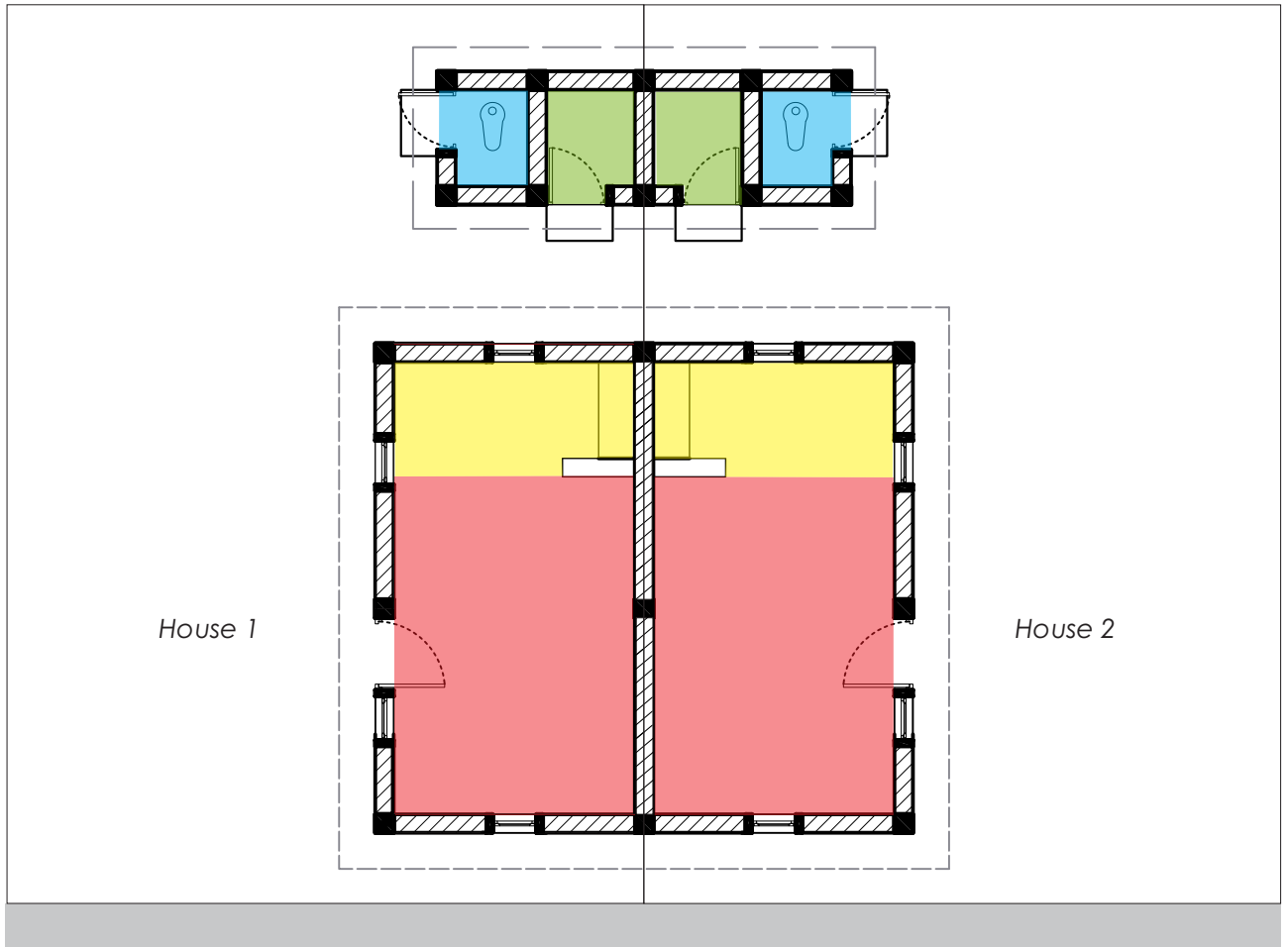

### Option 7

Built-up area: 30.53 m<sup>2</sup> each

Carpet area: 18.92 m<sup>2</sup> each

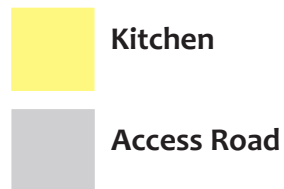

# Option 1

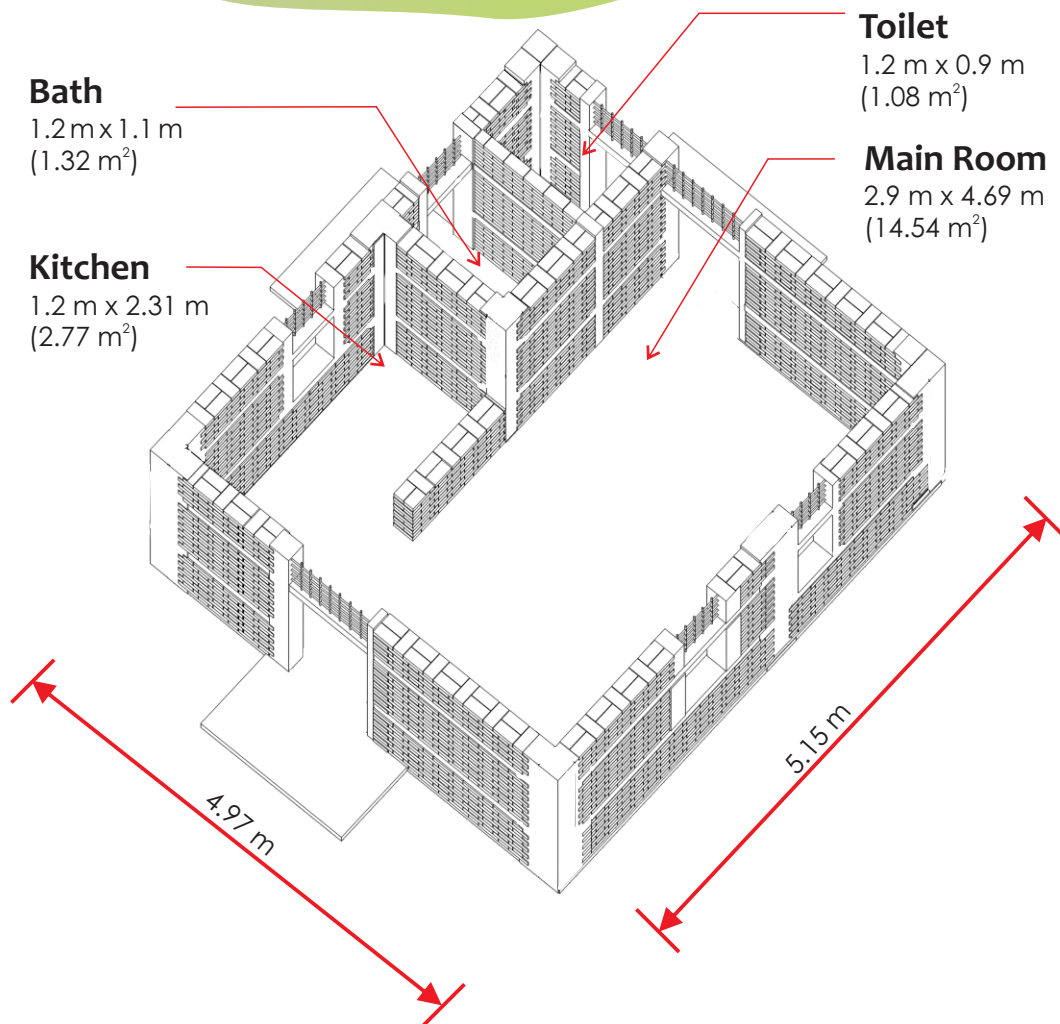
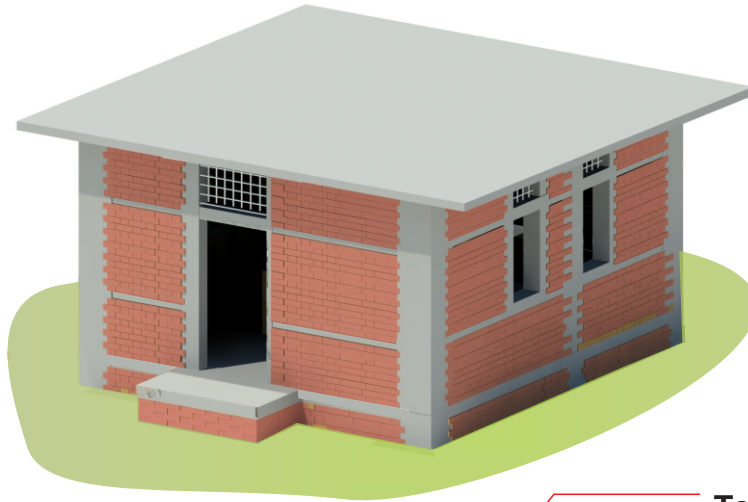

# Option 1

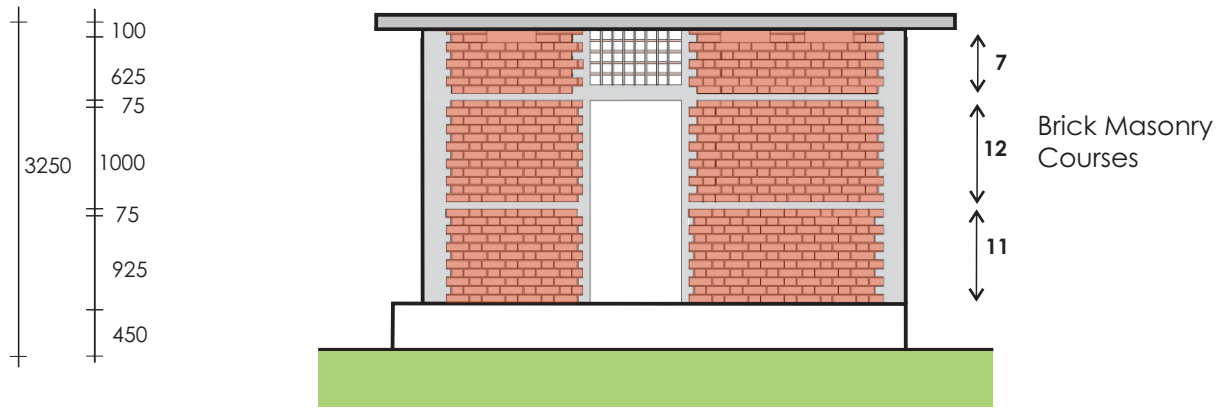

**Front Elevation**

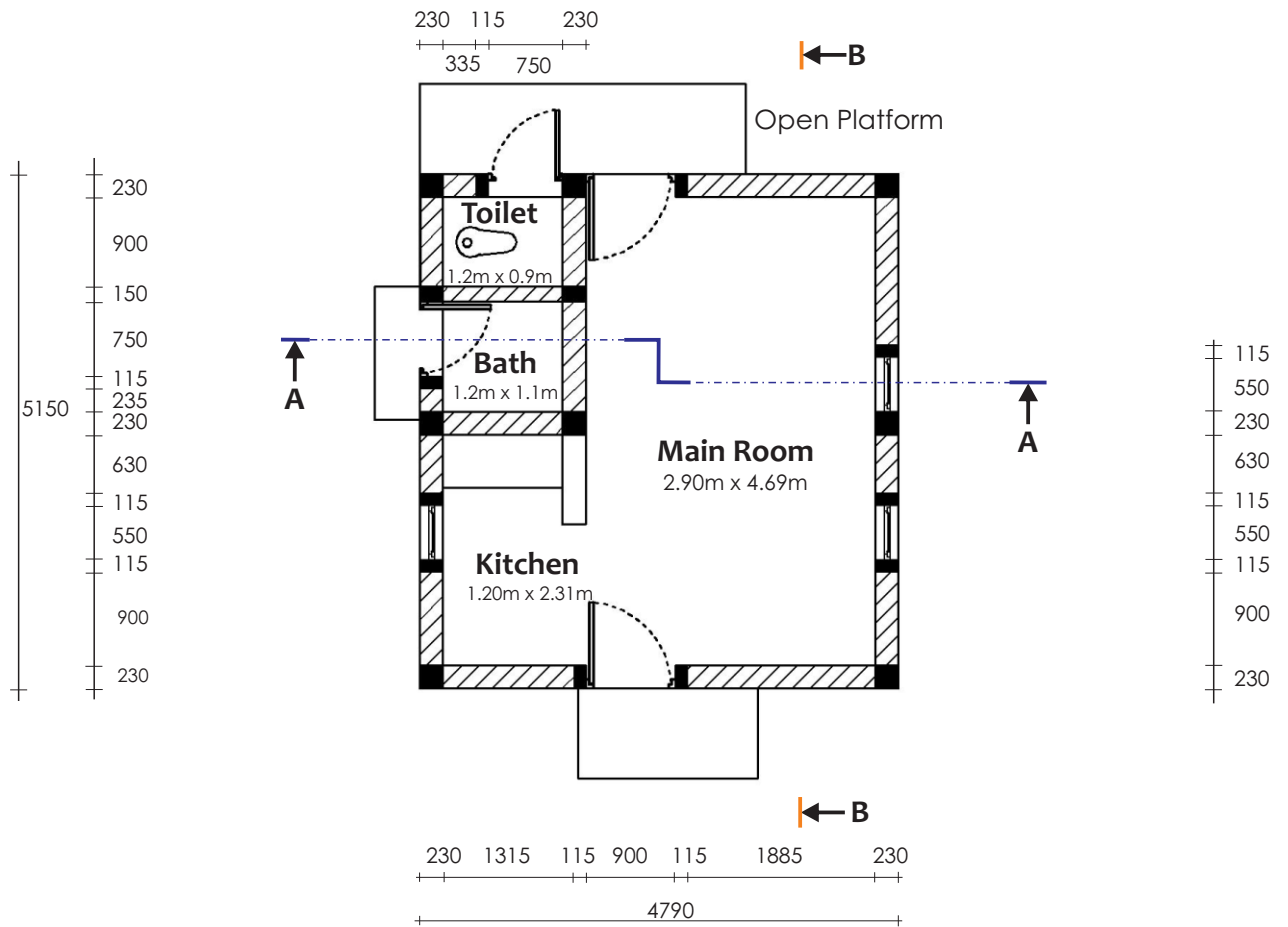

**Plan**

# Option 1

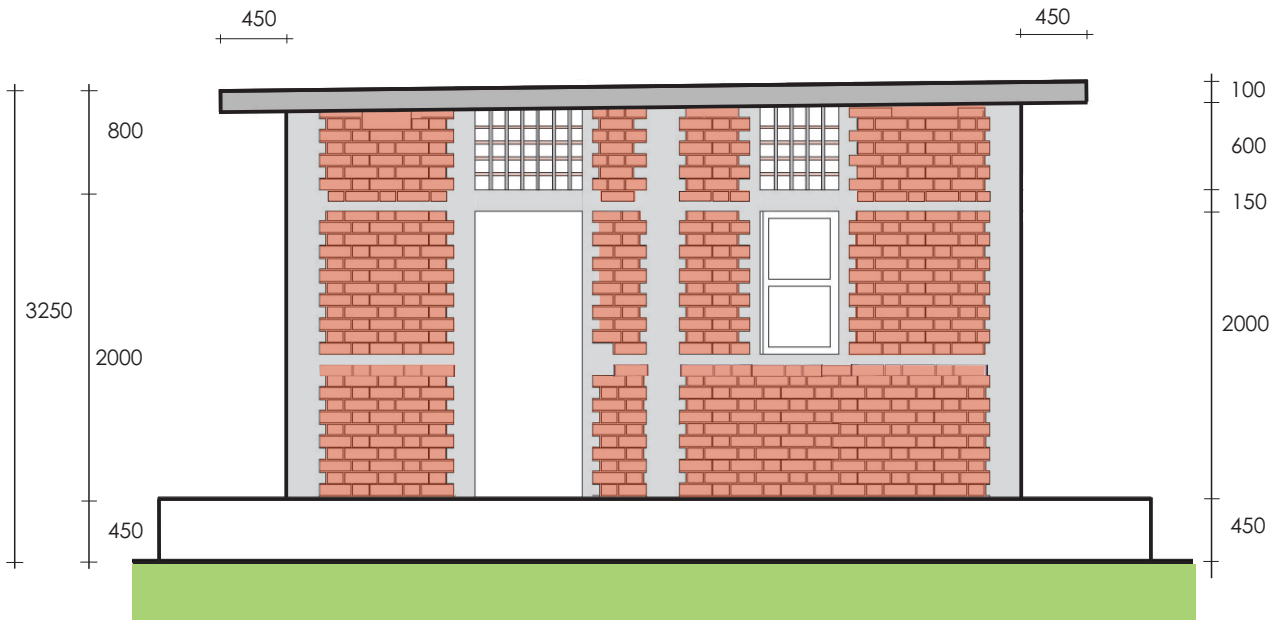

Left Elevation



Right Elevation

# Option 1

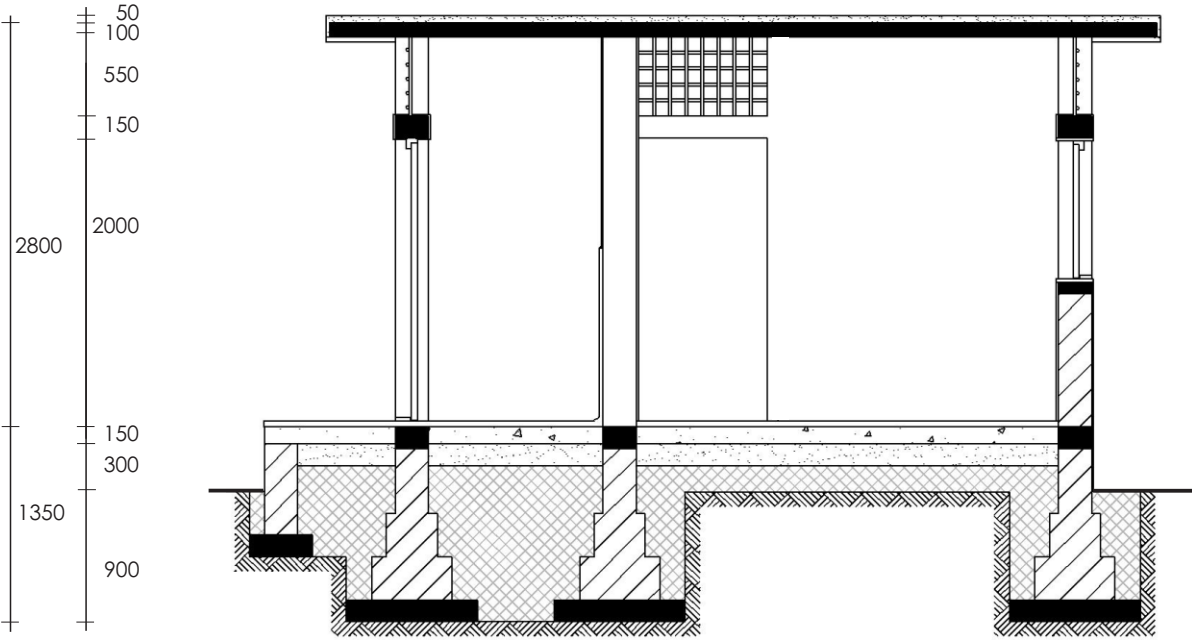

Section A-A

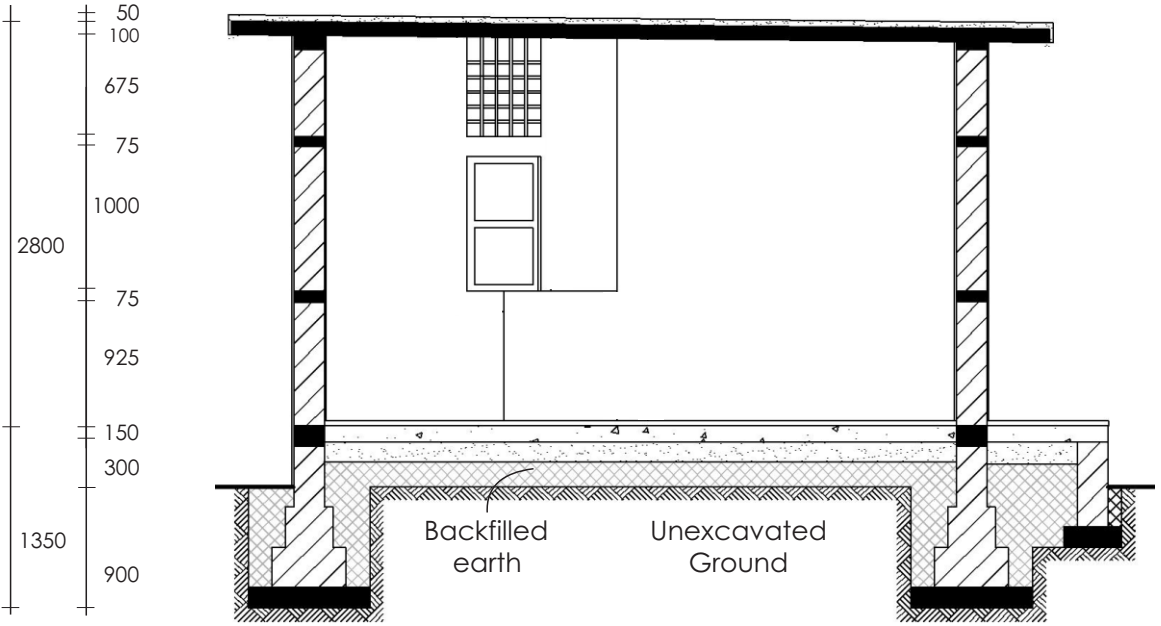

Section B-B

# Option 1

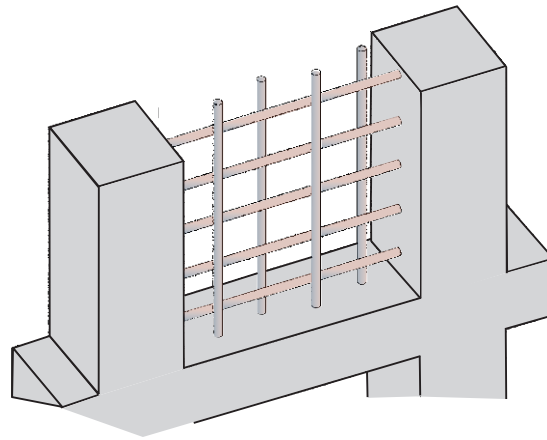

**Ventilator**  
with Built-in Steel Grill

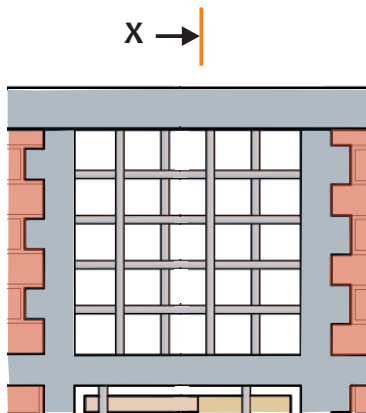

**Elevation**

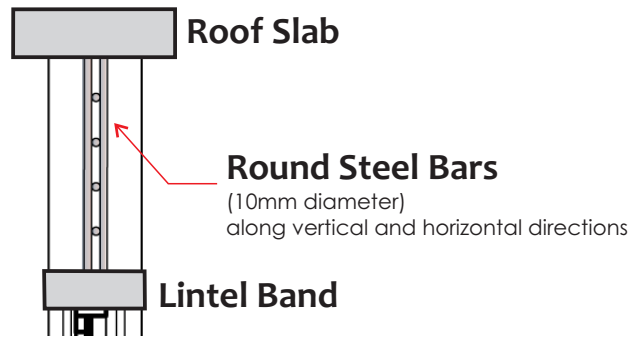

**Section X-X**

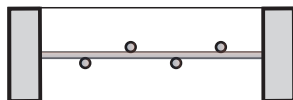

**Plan**

**Vertical RC Elements**

**Option 1**

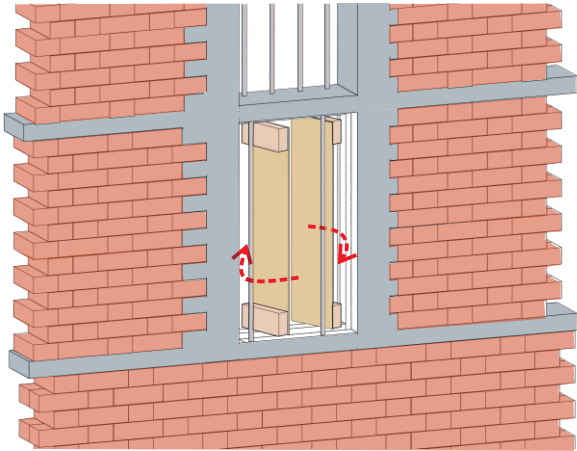

**Pivoted Window**  
Open Position

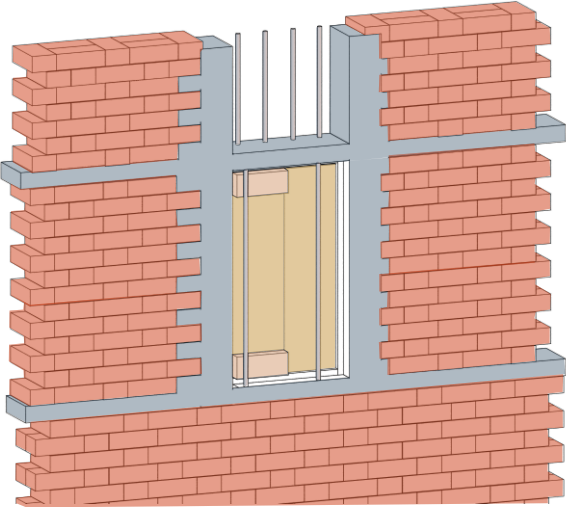

**Pivoted Window**  
Closed Position

# Option 1

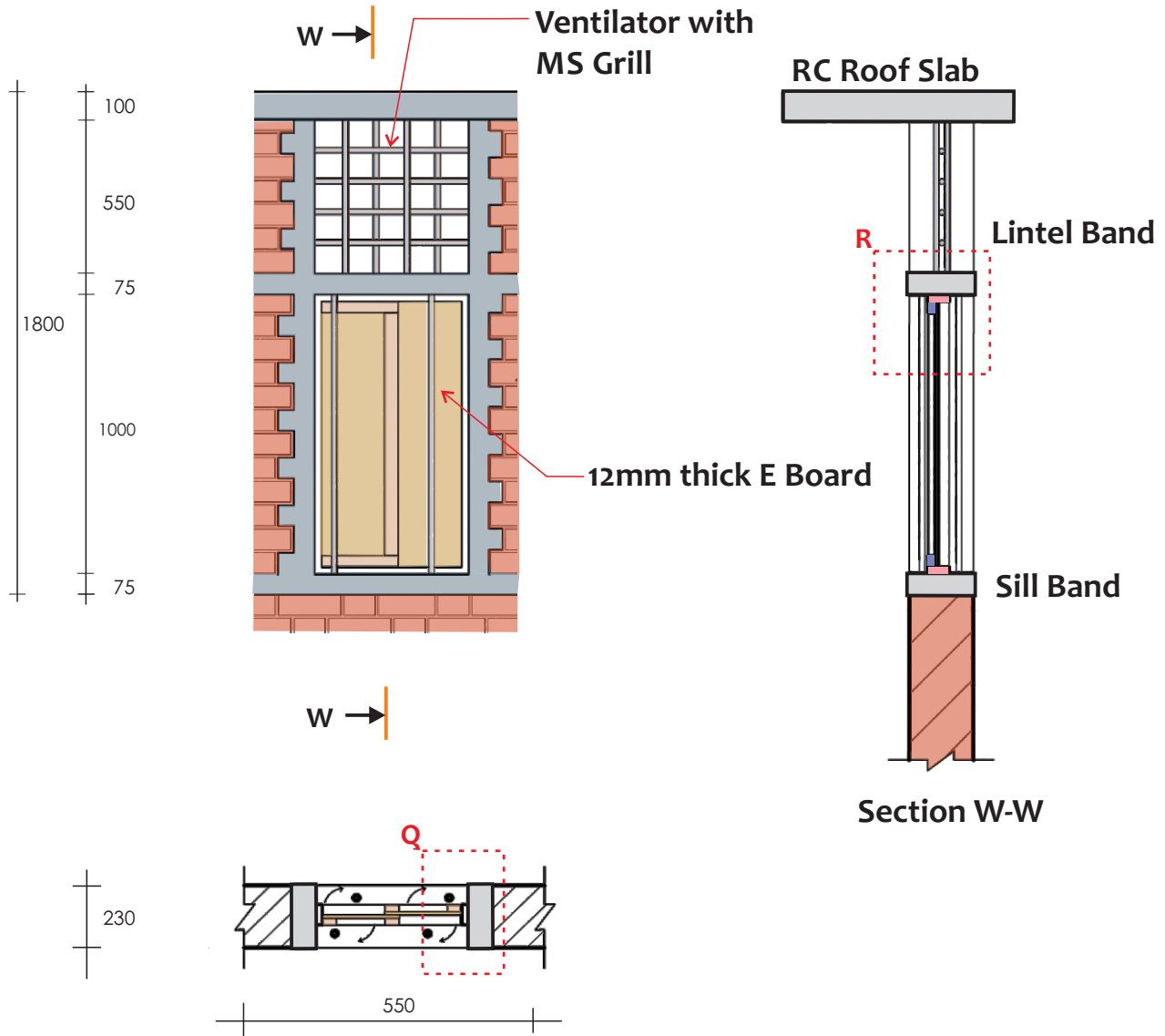

Window Details

# Option 1

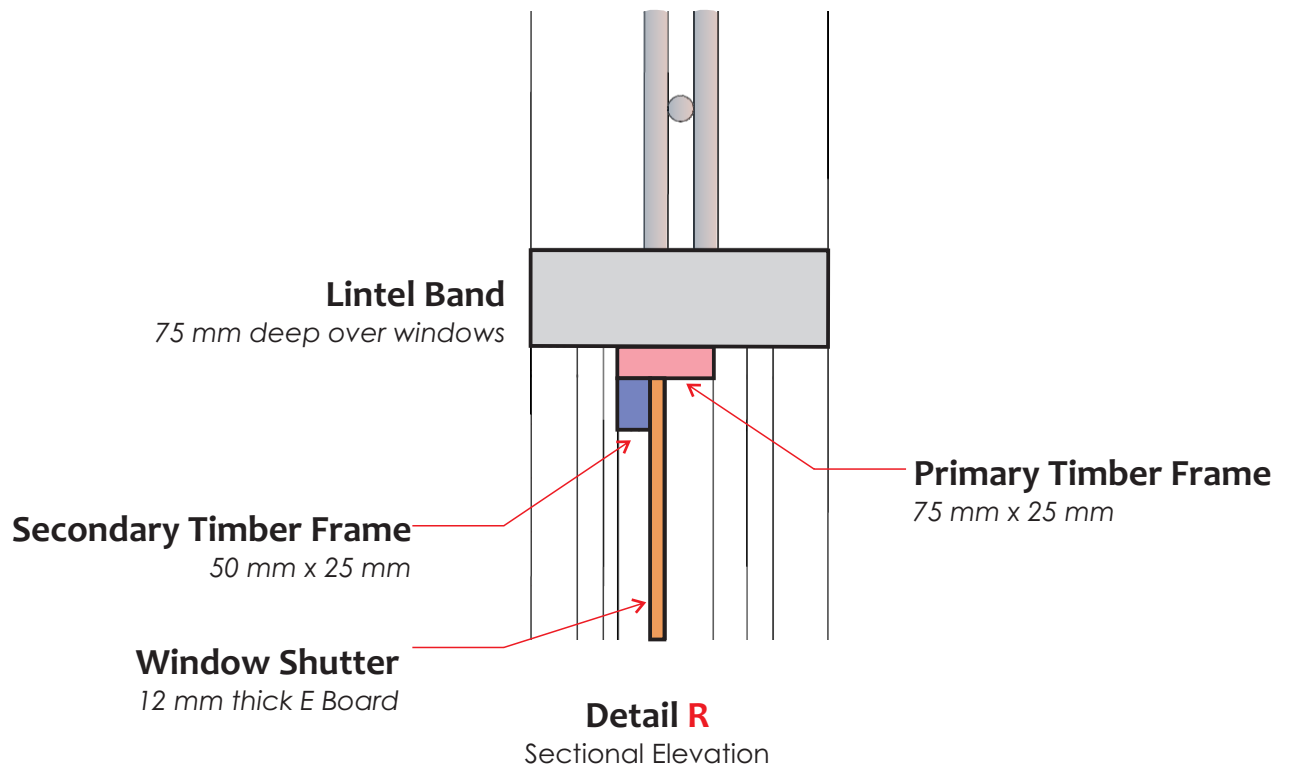
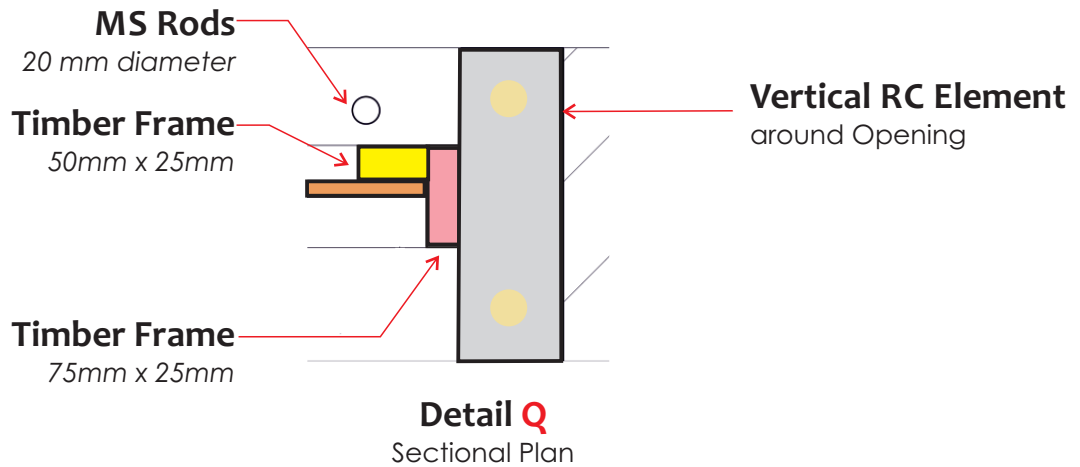

# Option 1

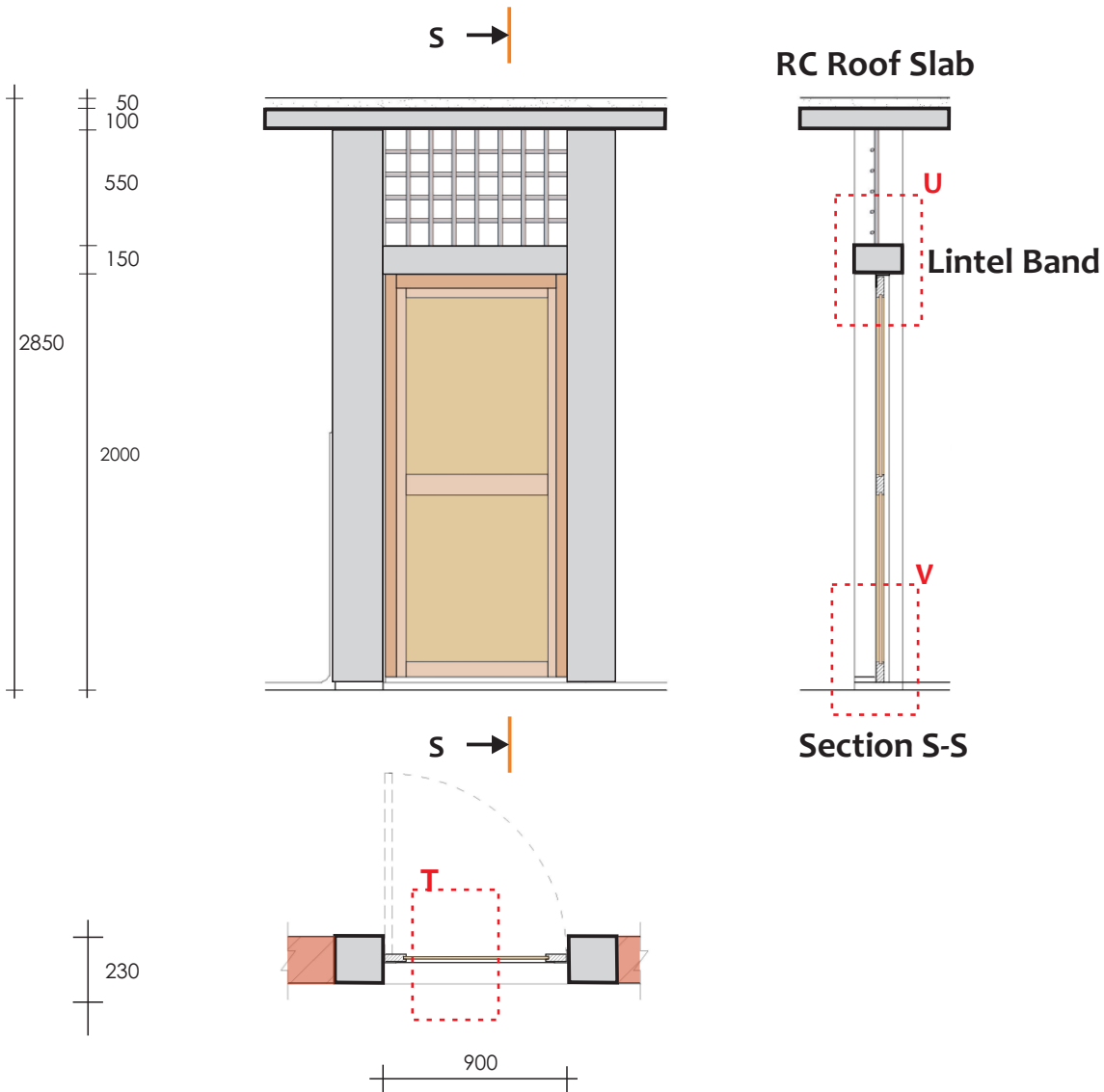

**Door Details**

# Option 1

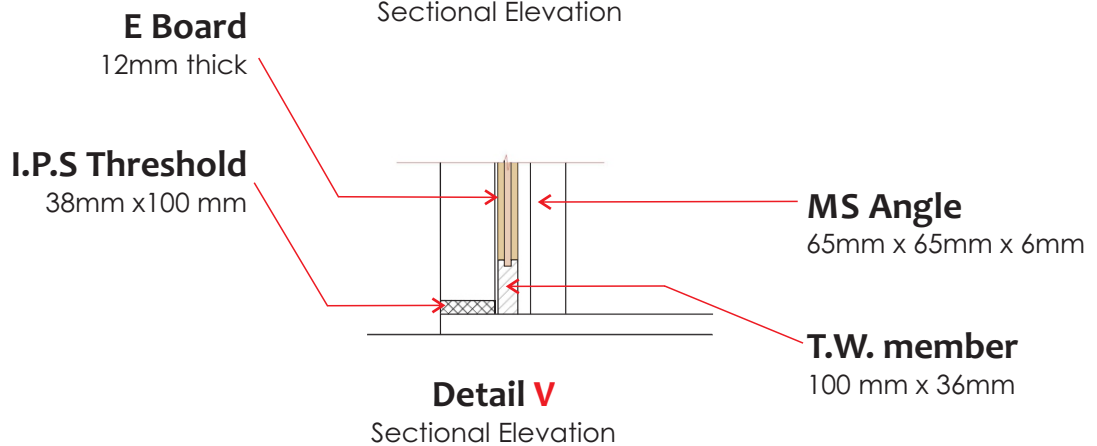
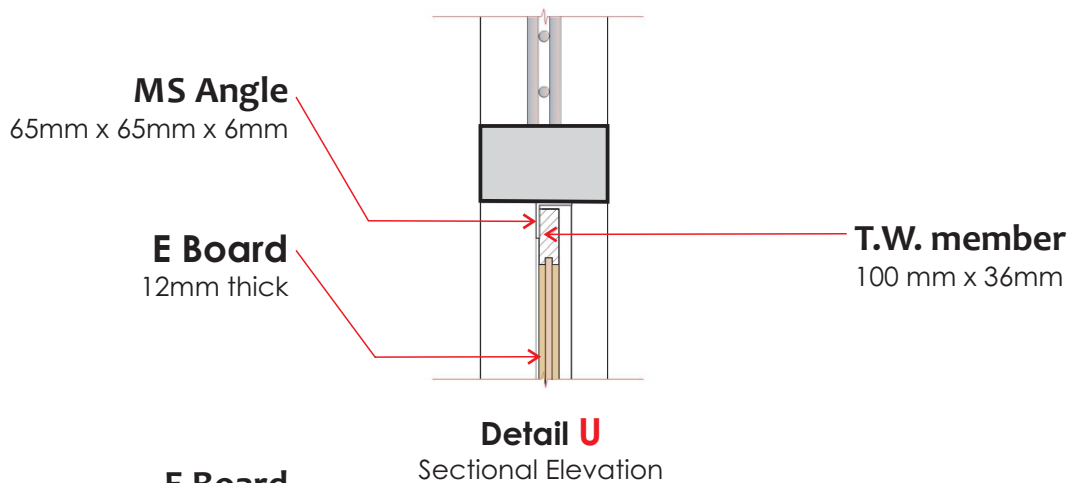
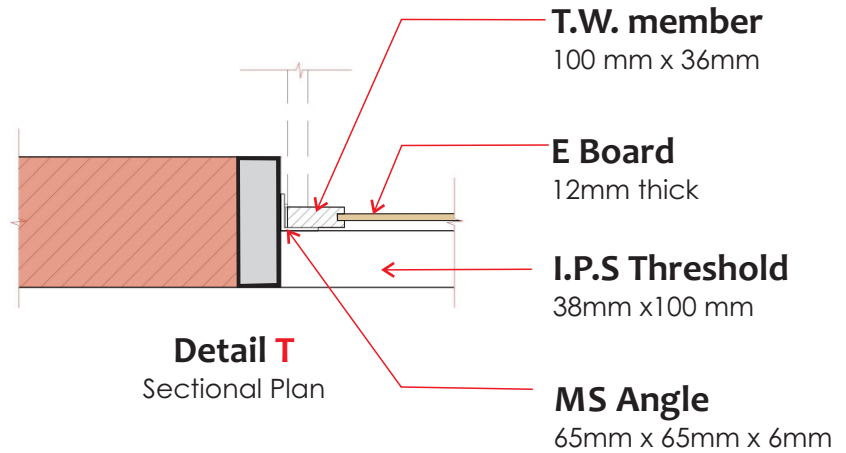

# Option 1

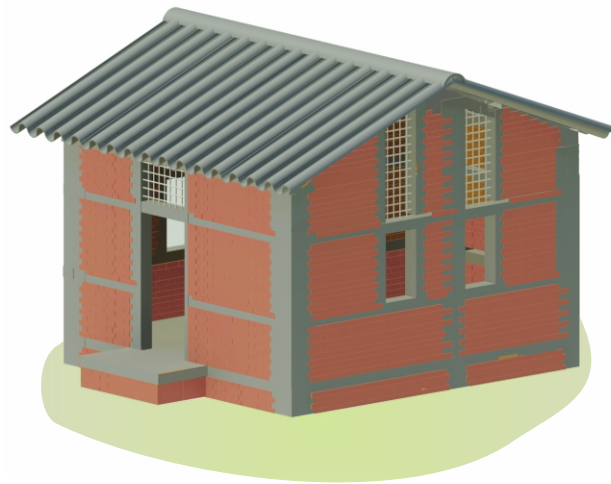

House with sloping roof

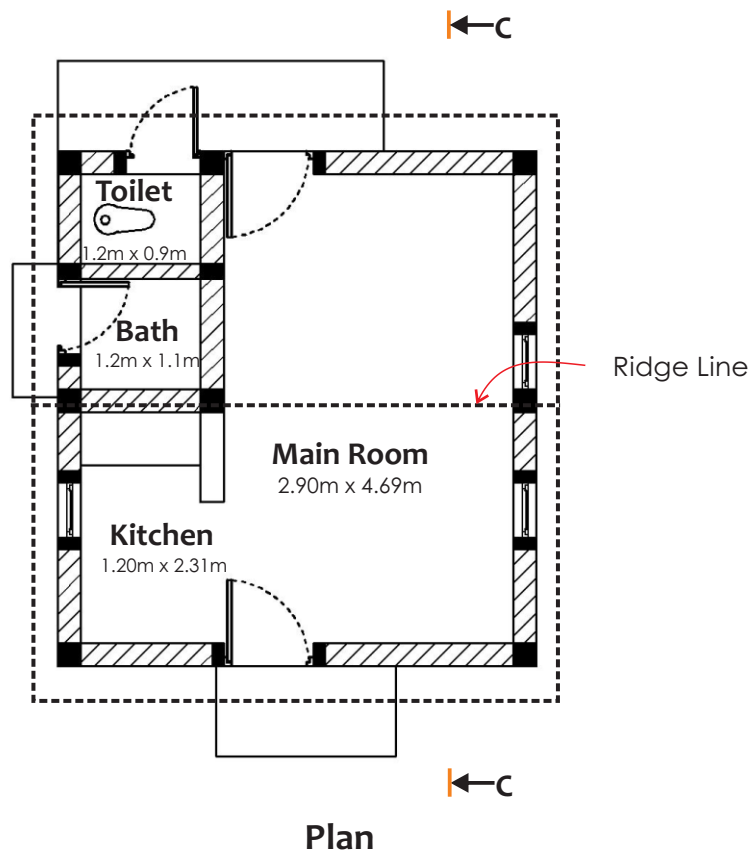

# Option 1

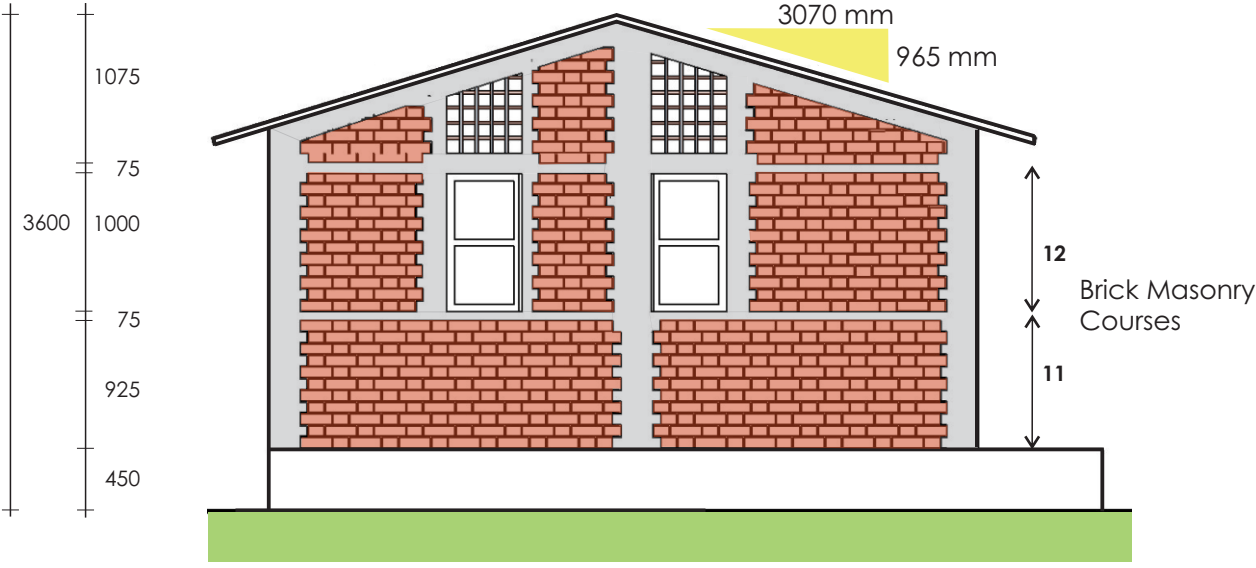

Right Elevation

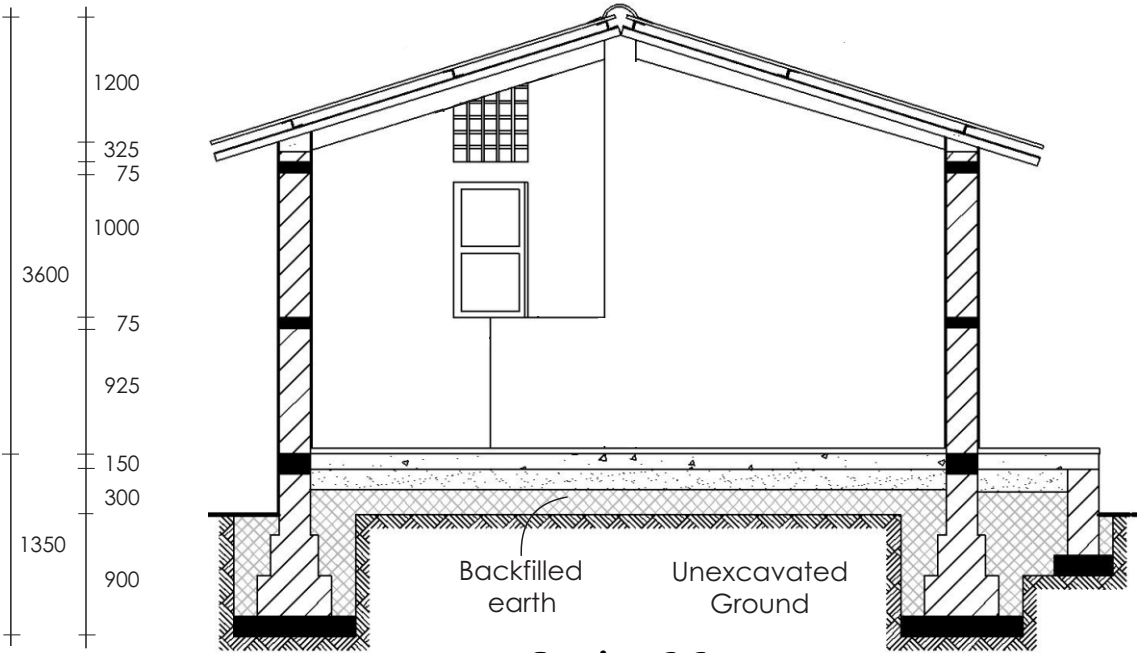

Section C-C

## Option 1 Extended

### How to extend my house ?

To extend the house,  
leave a 600mm projection  
from the Lintel Band  
in the direction of  
proposed expansion

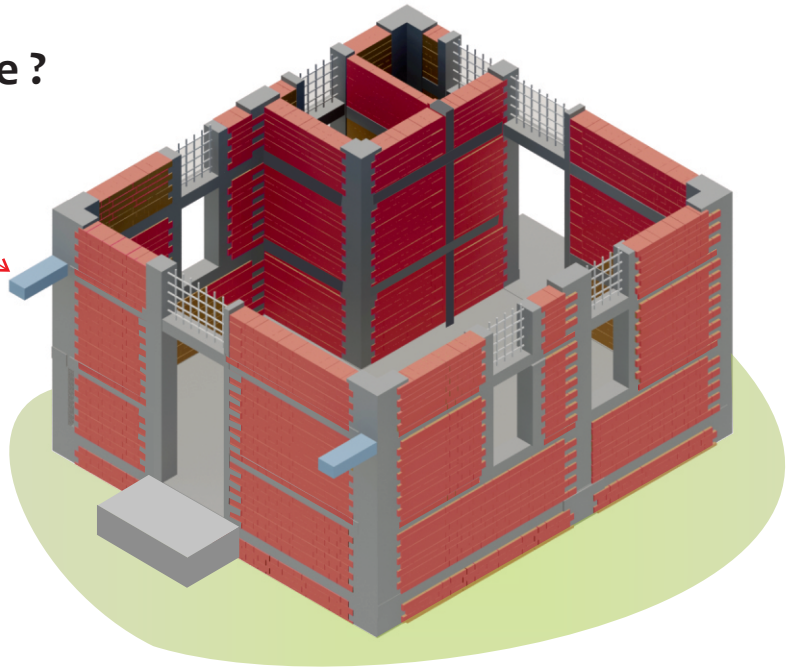

While extending the house,  
chip only the concrete  
from the projected lintel band  
left for future expansion

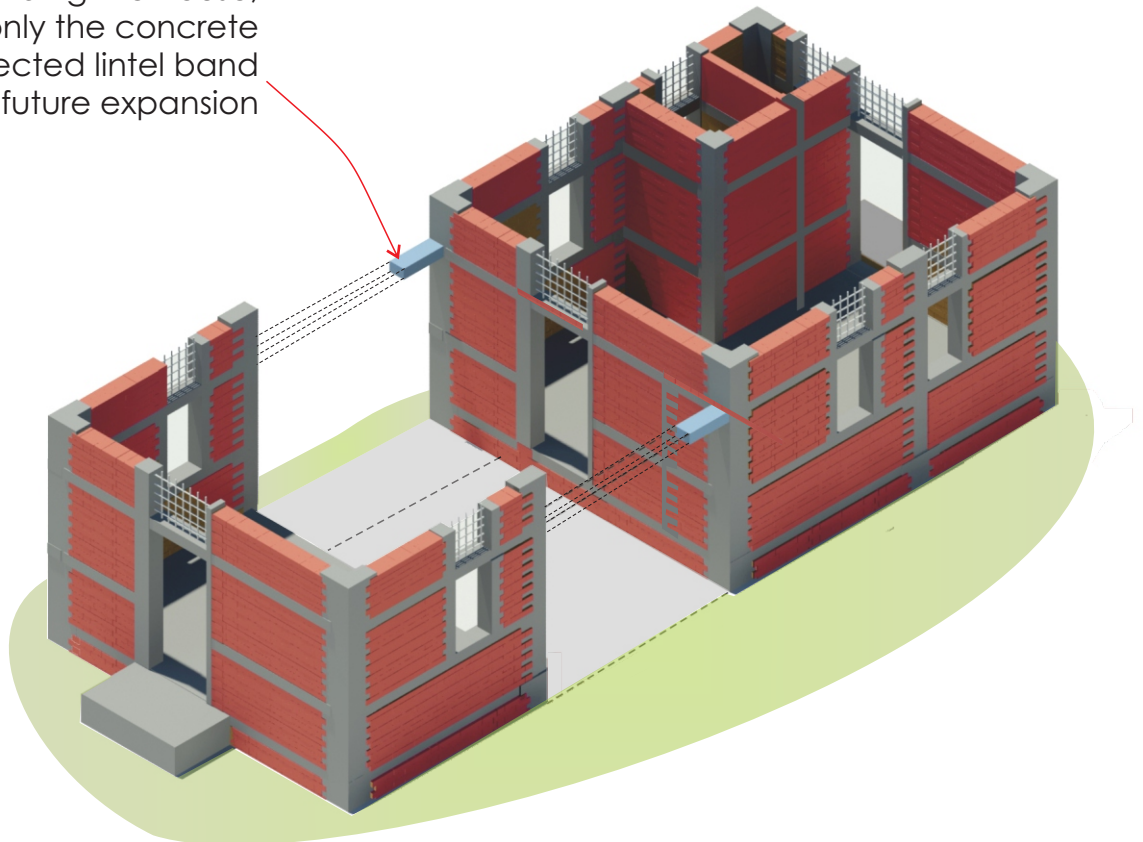

# Option 1 Extended

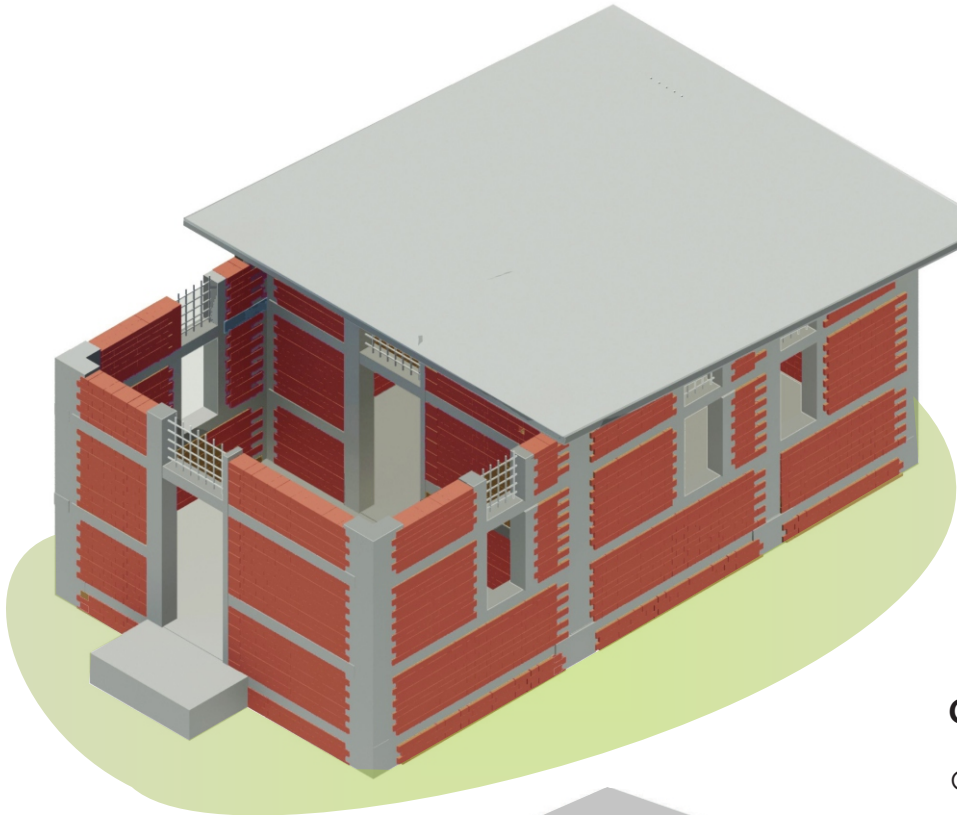

**Option 1 Extended**  
Built-up area: 40.14 m<sup>2</sup>  
Carpet area: 31.77 m<sup>2</sup>

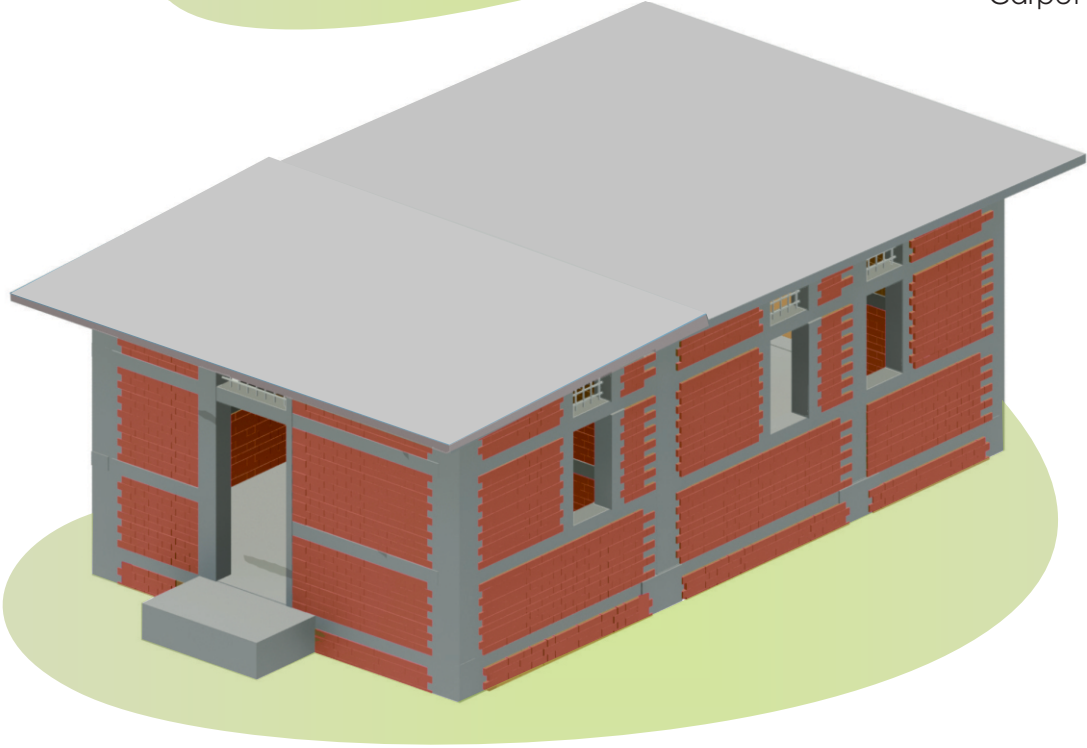

# Option 1 Extended

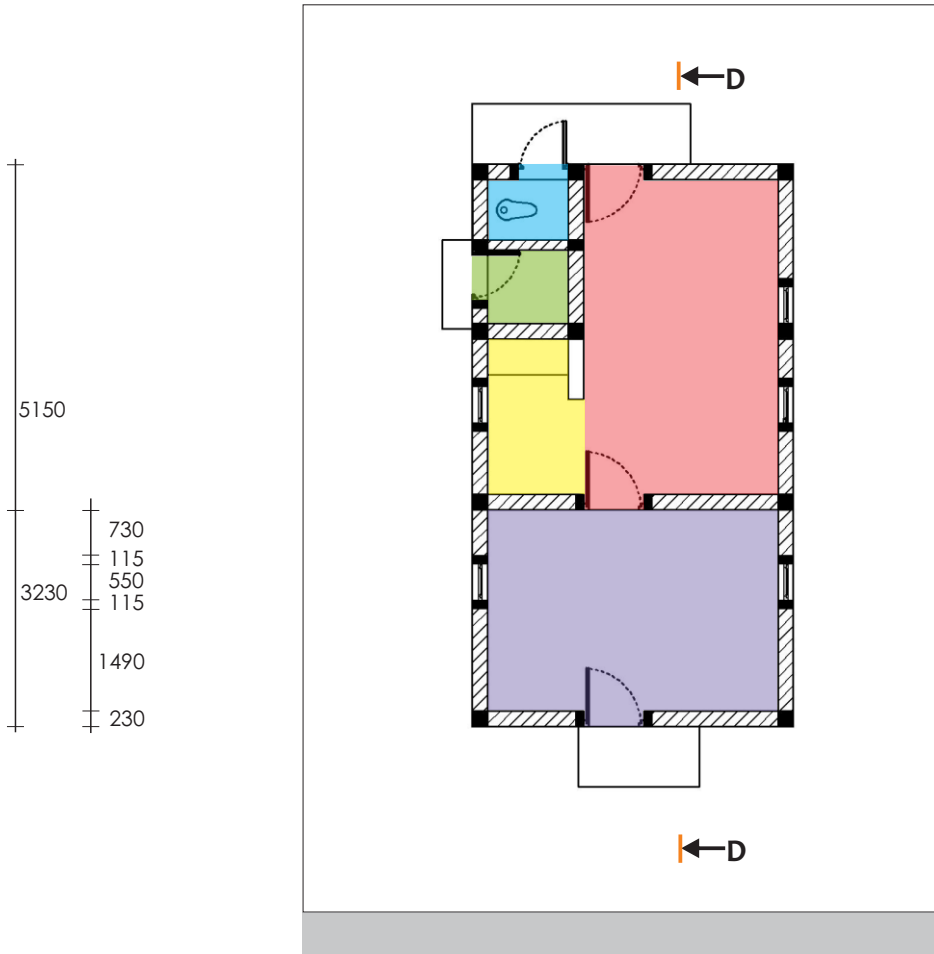

Plan



# Option 1 Extended

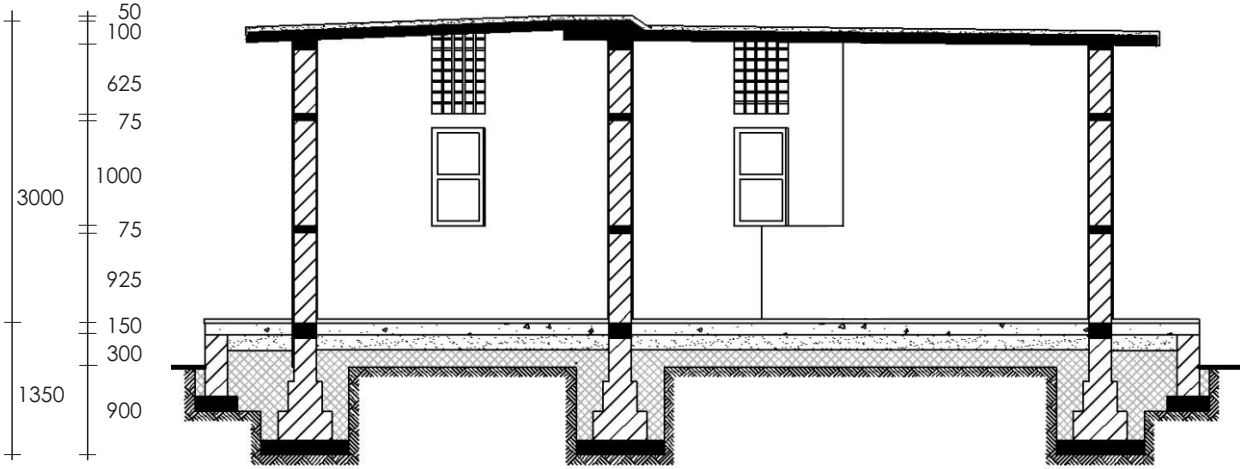

Section D-D

## Option 2

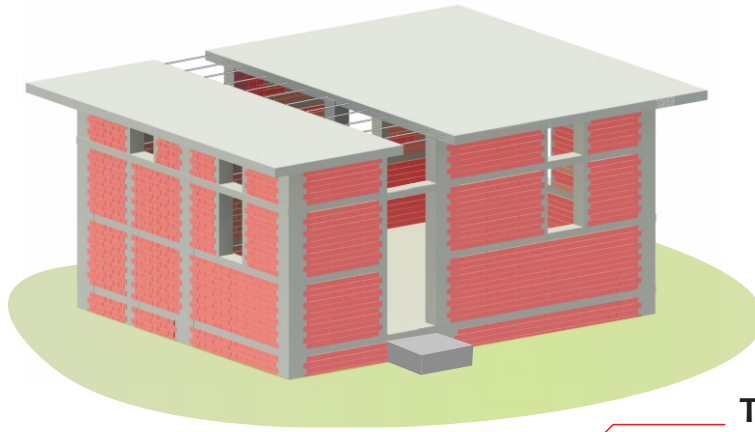

**Bath**  
1.20 m x 1.10 m  
(1.32 m<sup>2</sup>)

**Kitchen**  
1.20 m x 2.31 m  
(2.77 m<sup>2</sup>)

**Toilet**  
1.20 m x 0.90 m  
(1.08 m<sup>2</sup>)

**Main Room**  
3.20 m x 4.69 m  
(14.54 m<sup>2</sup>)

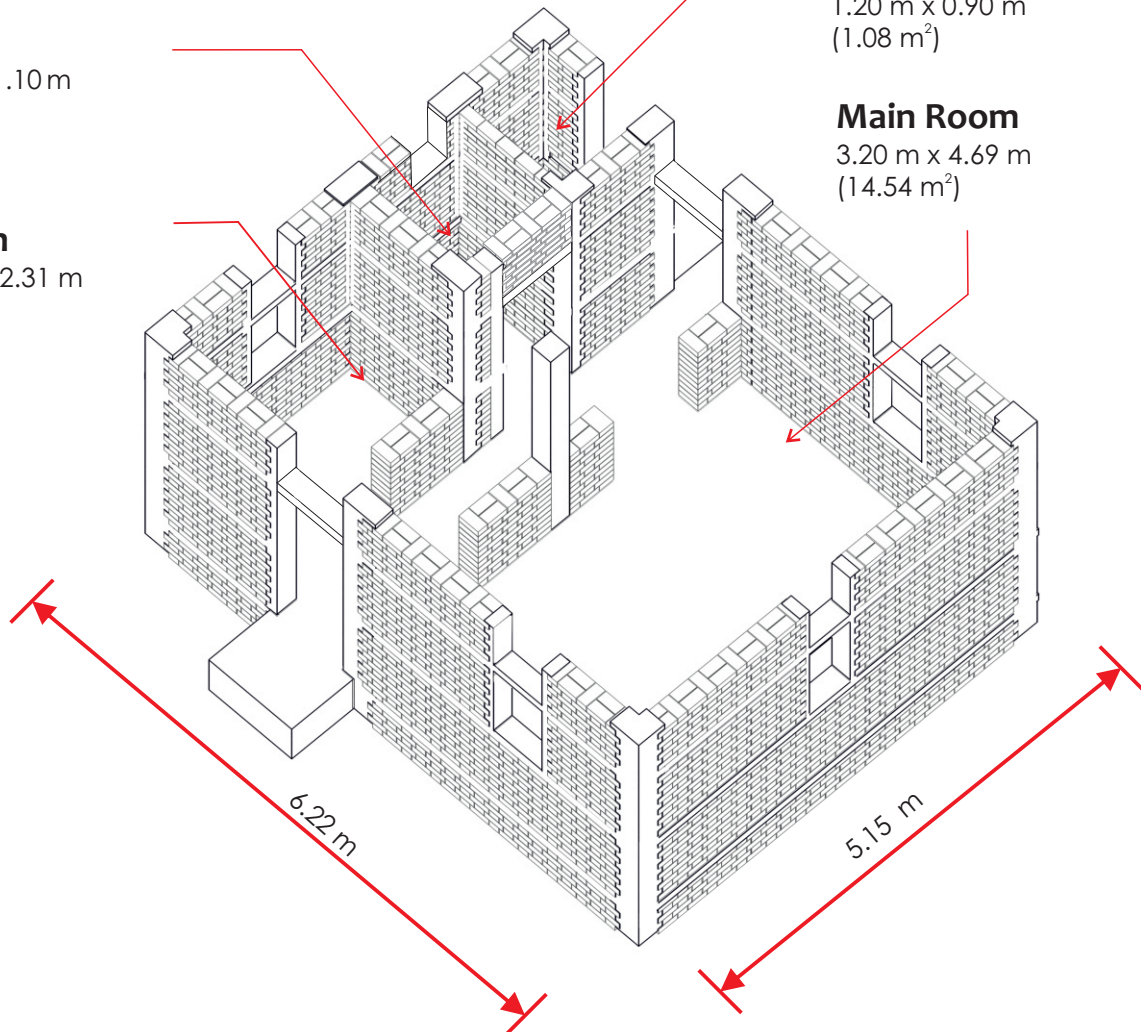

# Option 2



**Front Elevation**

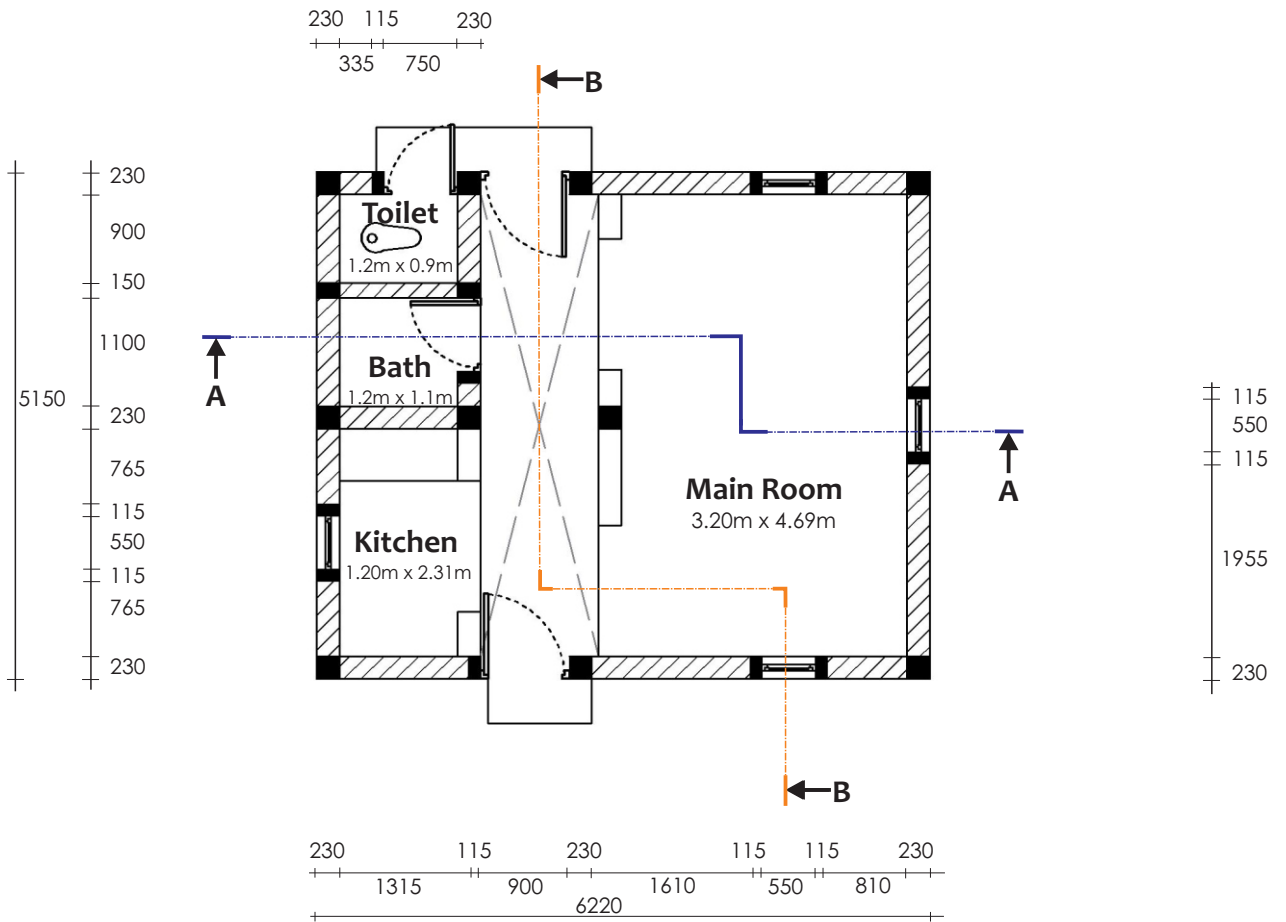

**Plan**

# Option 2

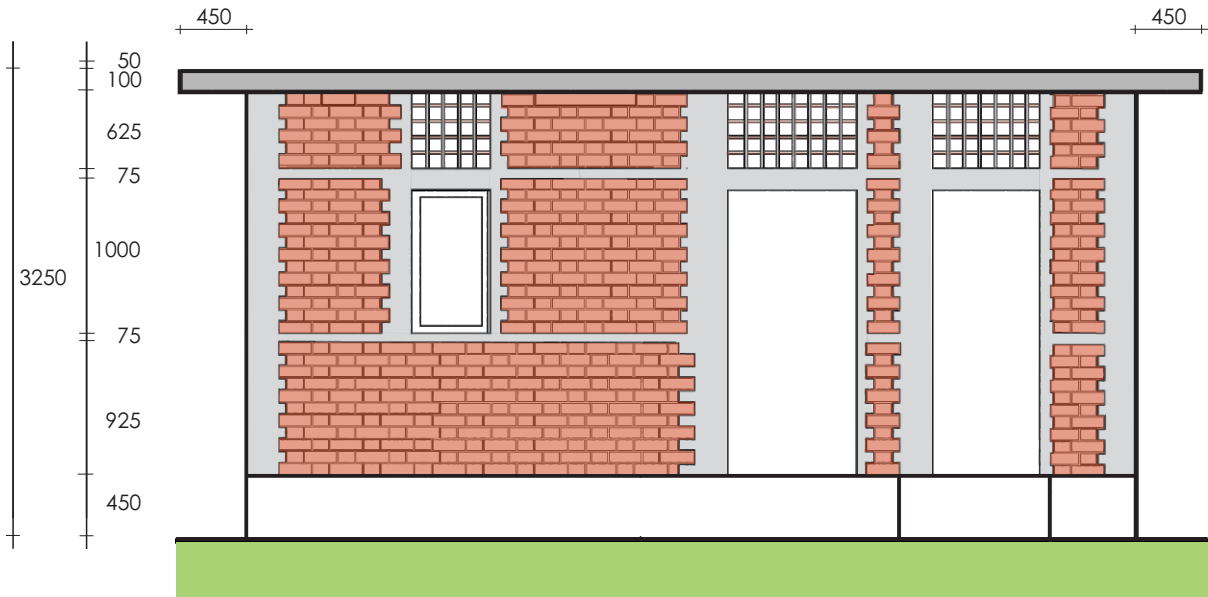

Back Elevation

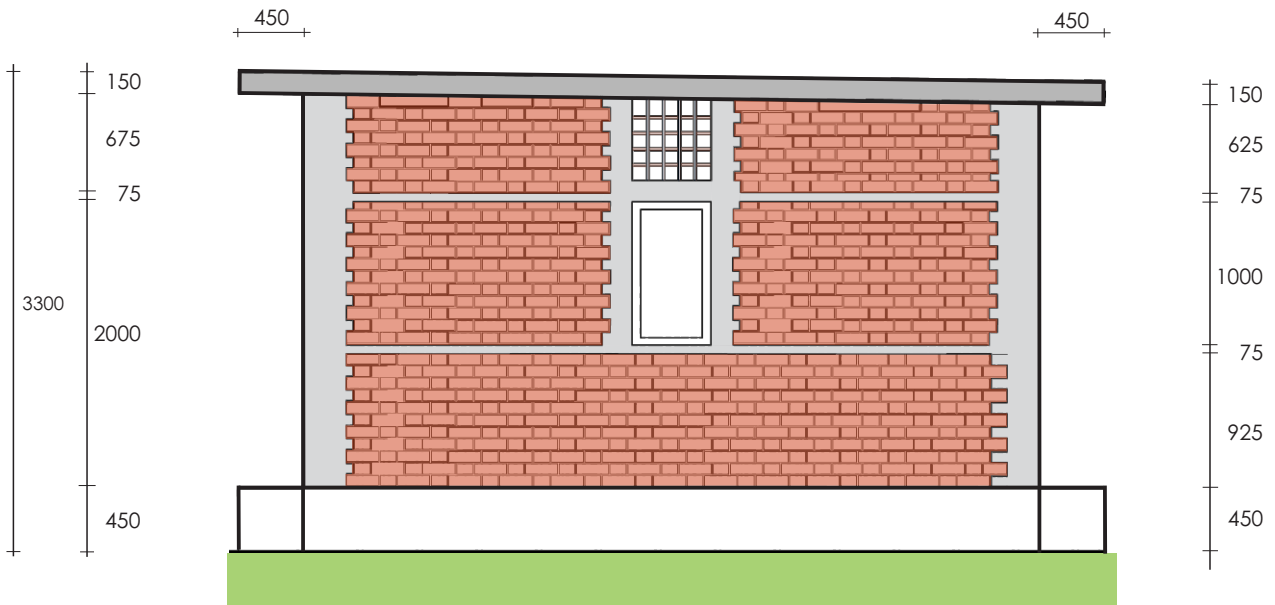

Right Elevation

# Option 2

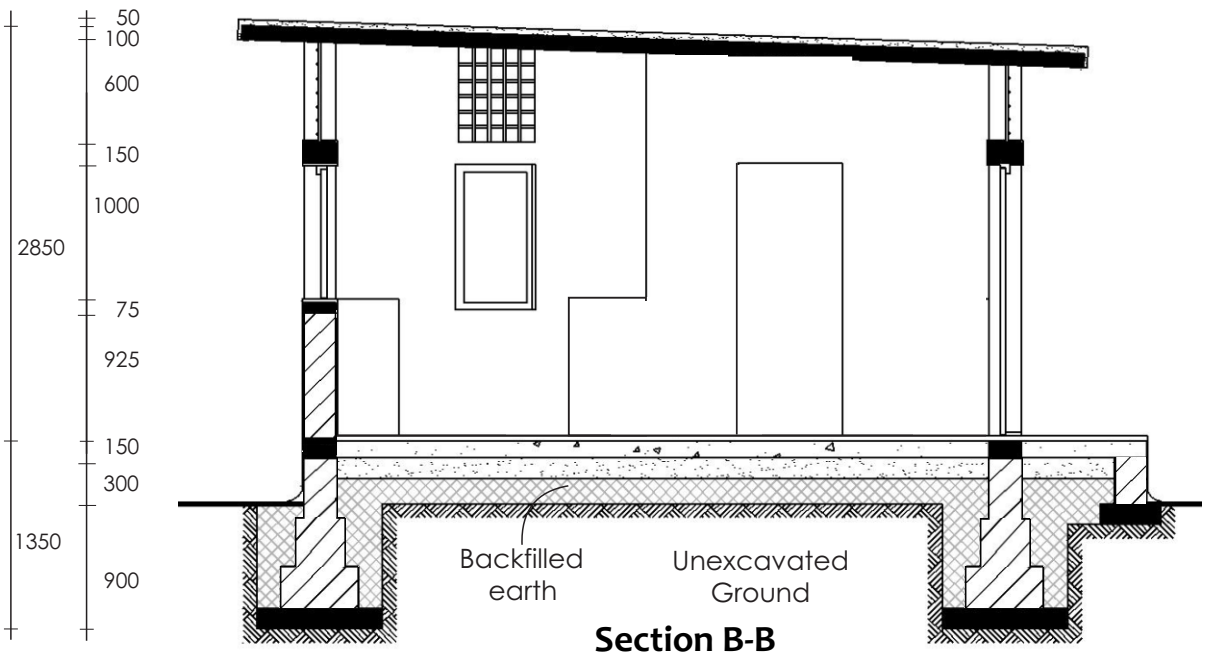
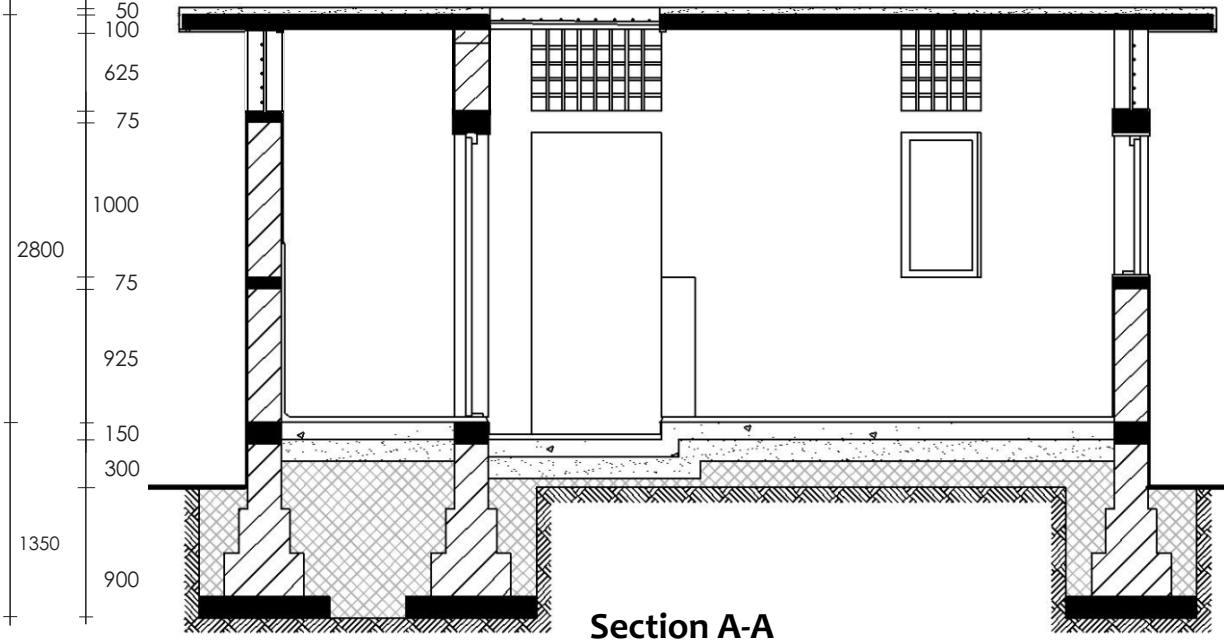

## Option 2



House with sloping roof

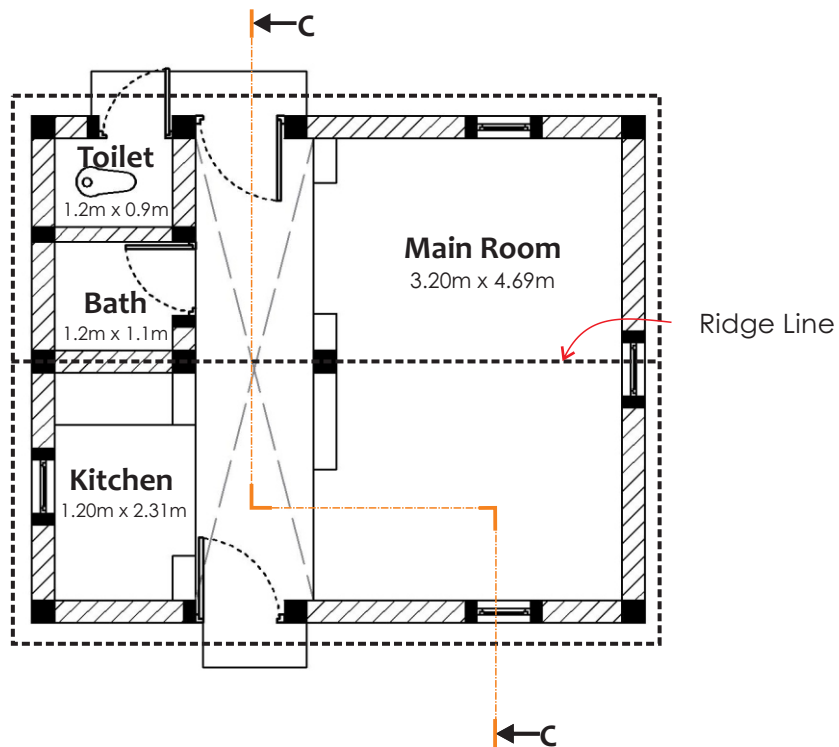

Plan

# Option 2

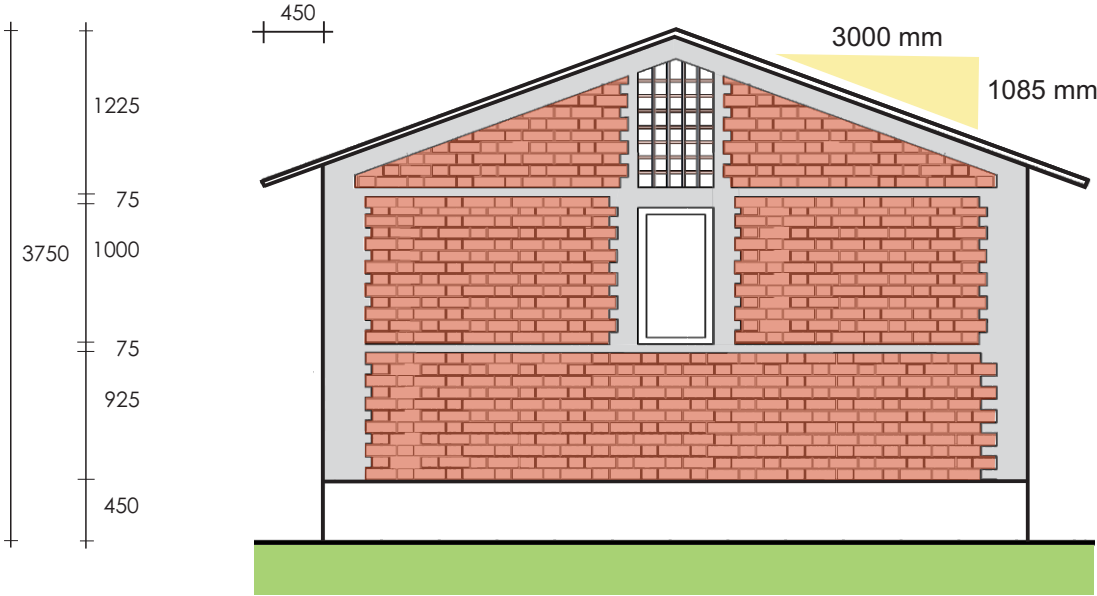

**Right Side Elevation**

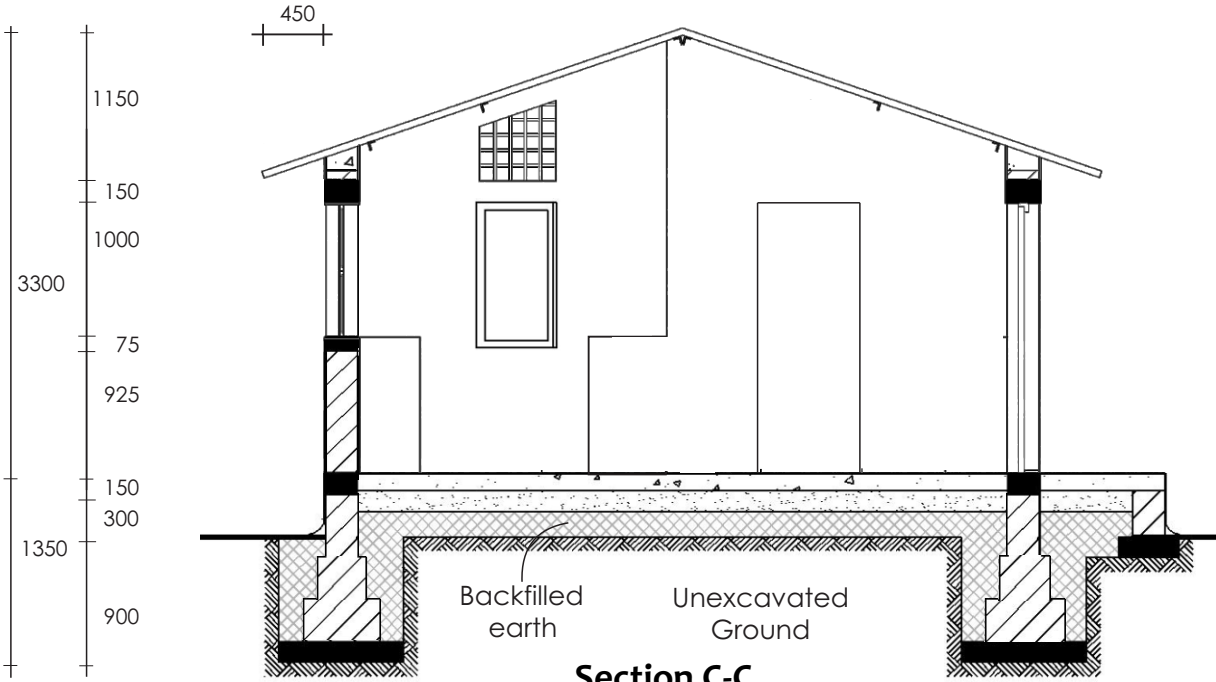

**Section C-C**

## Option 2 Extended

### How to extend my house ?

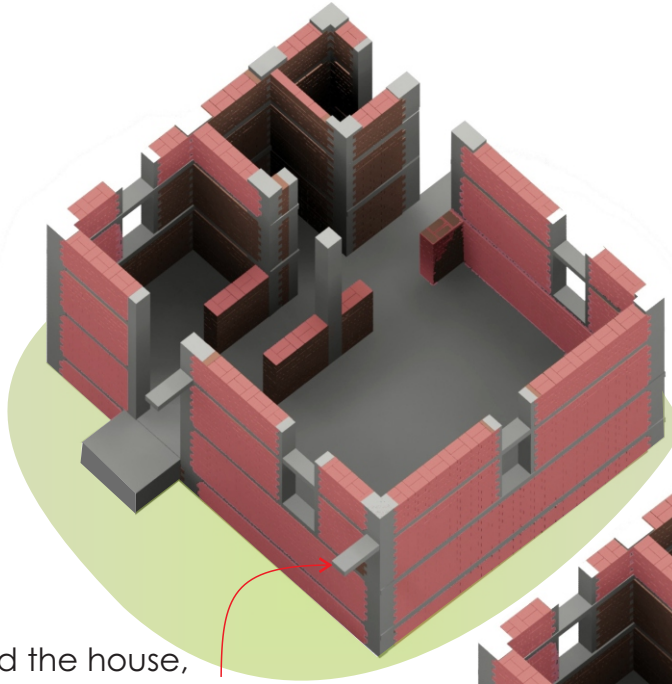

To extend the house,  
leave a 600mm projection  
from the Lintel Band  
in the direction of  
proposed expansion

While extending the house,  
chip only the concrete  
from the projected lintel band  
left for future expansion

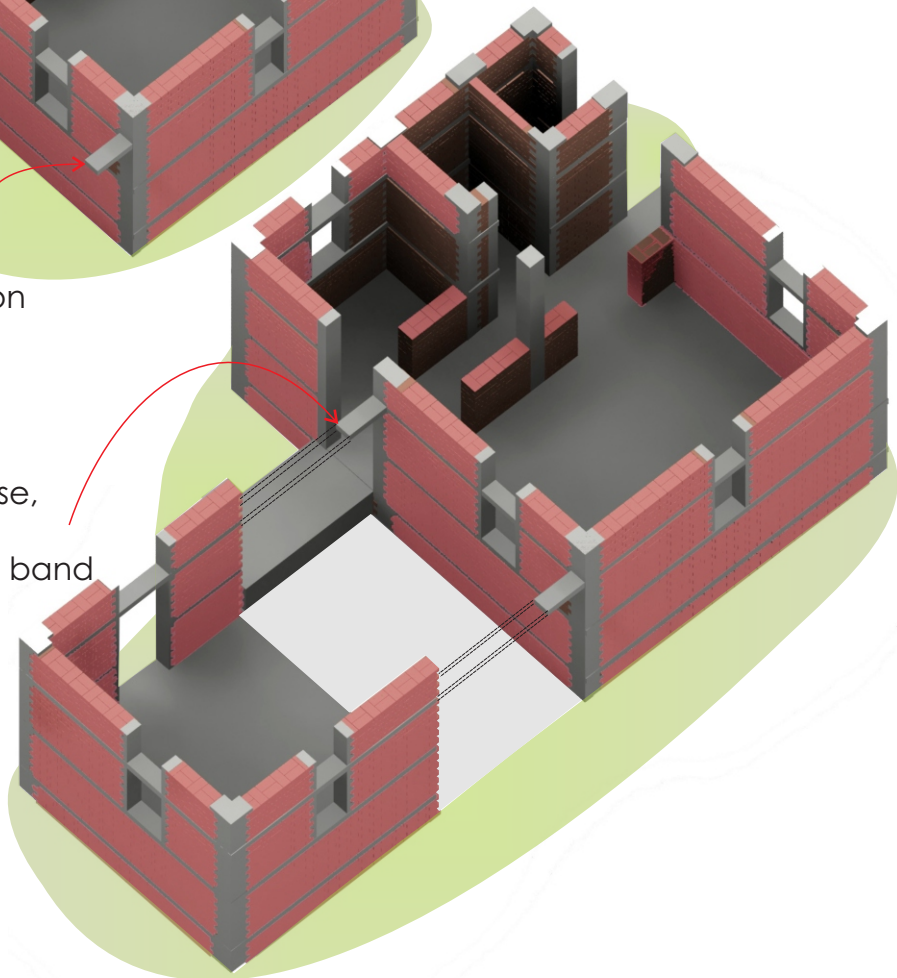

# Option 2 Extended

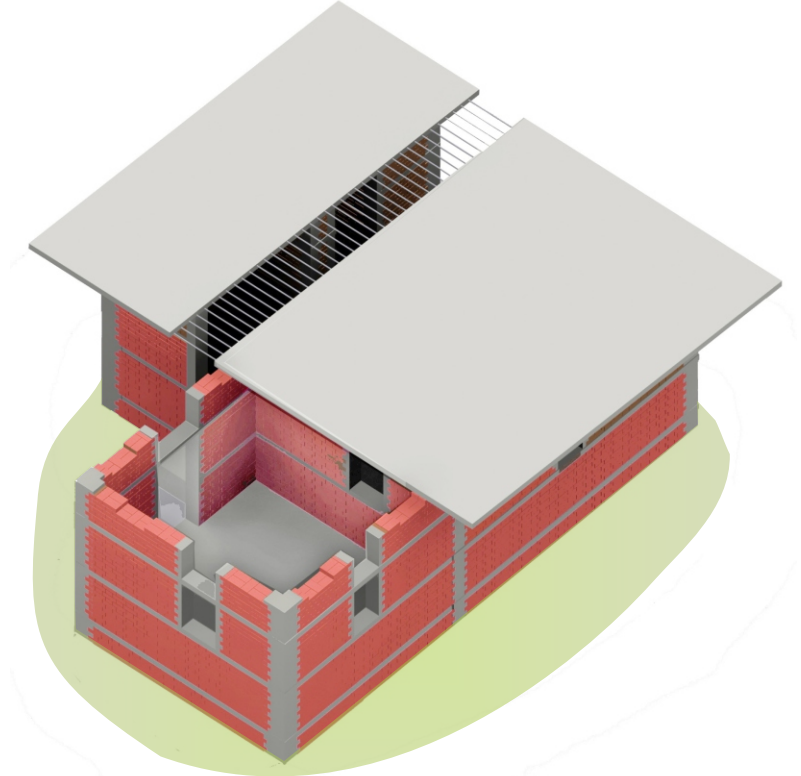

## Option 2 Extended

Built-up area: 43.85 m<sup>2</sup>

Carpet area: 29.78 m<sup>2</sup>

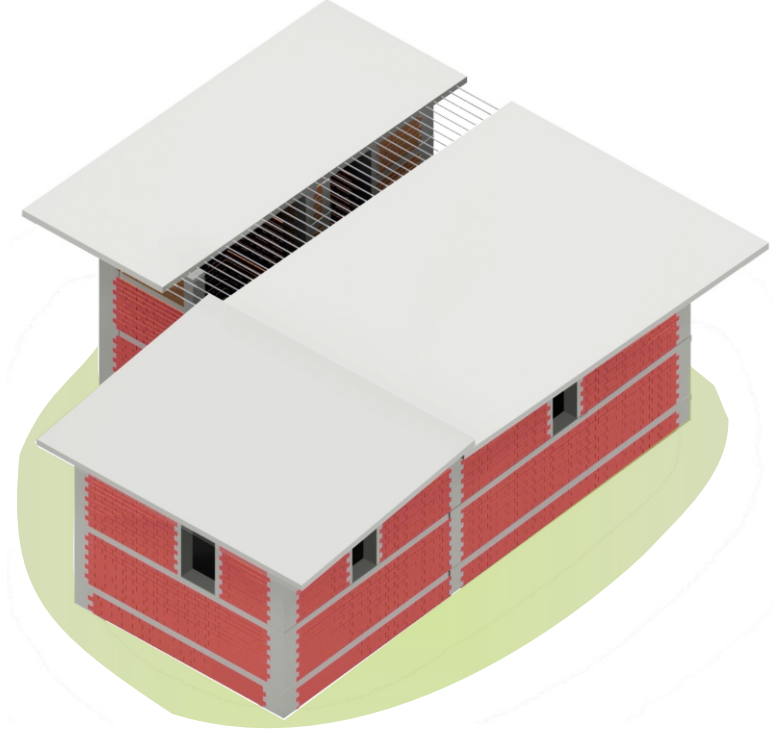

# Option 2 Extended

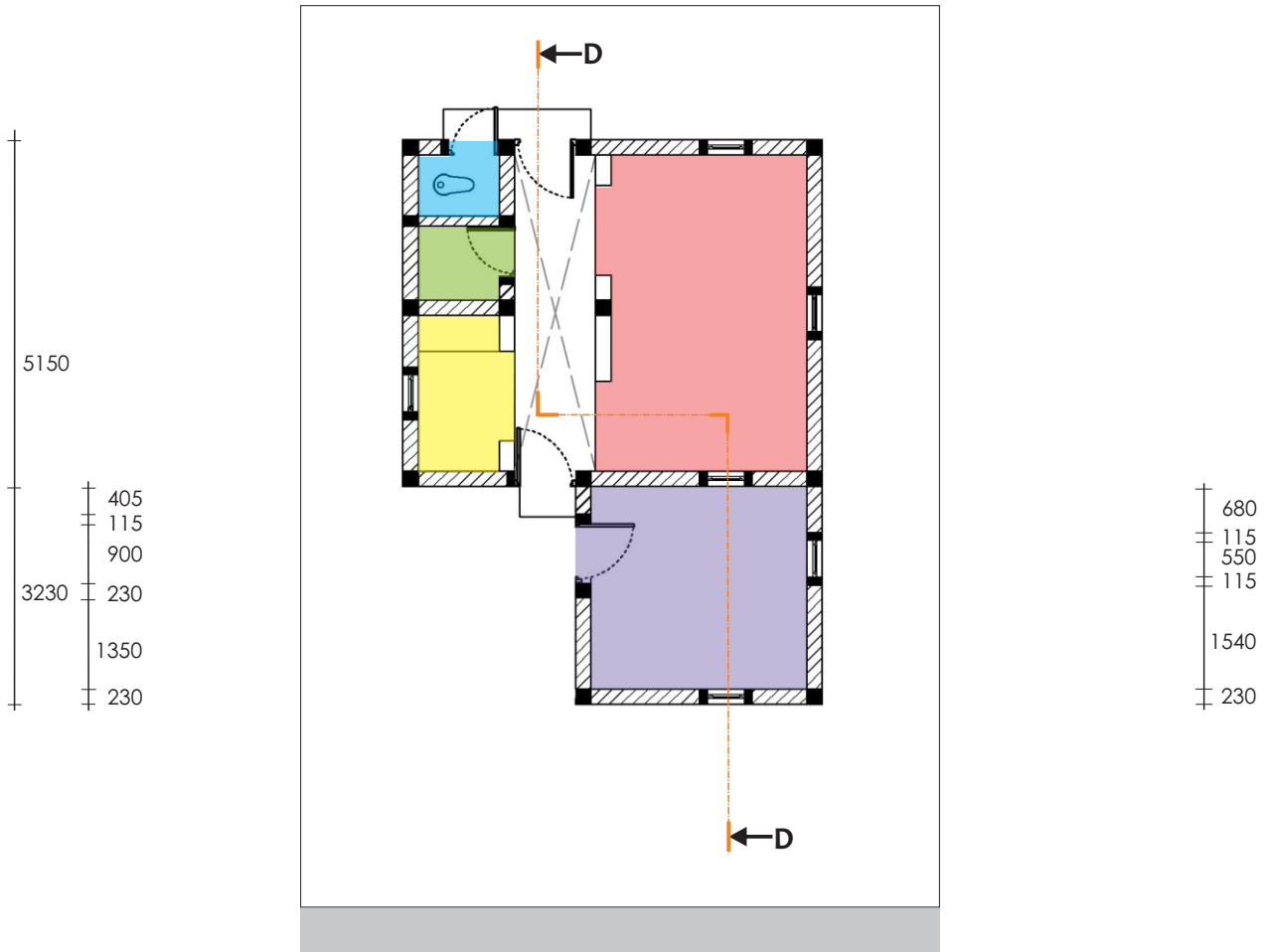

Plan



# Option 2 Extended

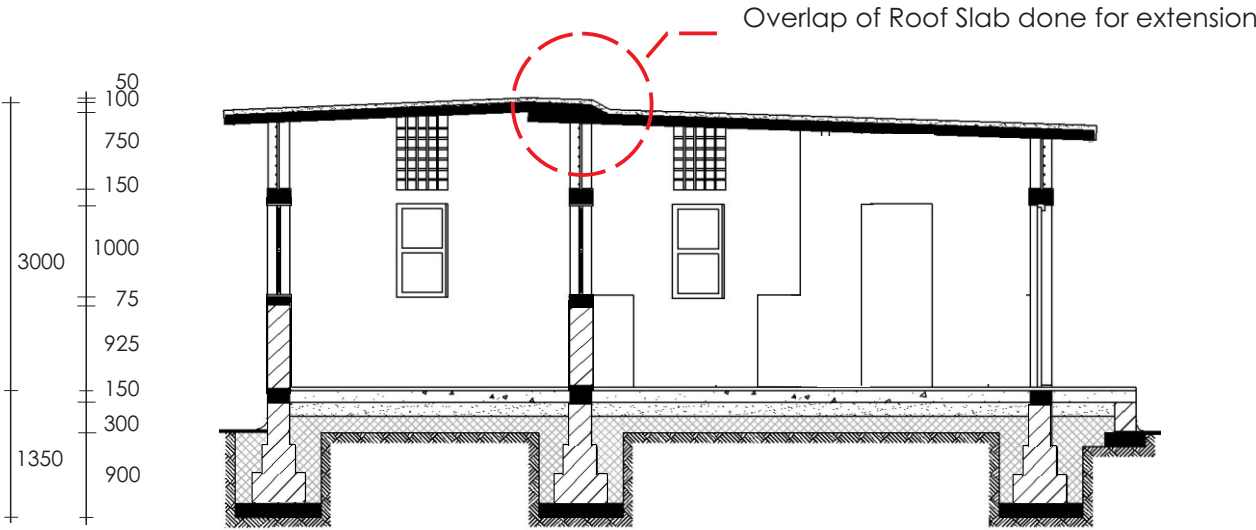

Section D-D

## Option 3

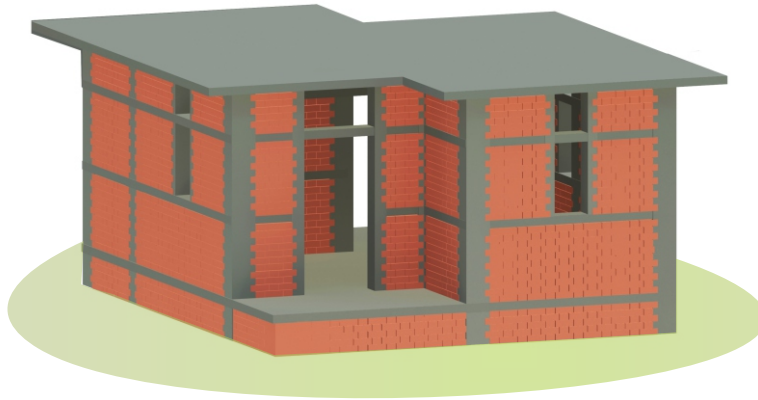

**Bath**  
1.2 m x 1.1 m  
(1.32 m<sup>2</sup>)

**Toilet**  
1.2 m x 0.9 m  
(1.08 m<sup>2</sup>)

**Main Room**  
3.00 m x 4.76 m  
(14.54 m<sup>2</sup>)

**Kitchen**  
1.10 m x 2.23 m  
(2.77 m<sup>2</sup>)

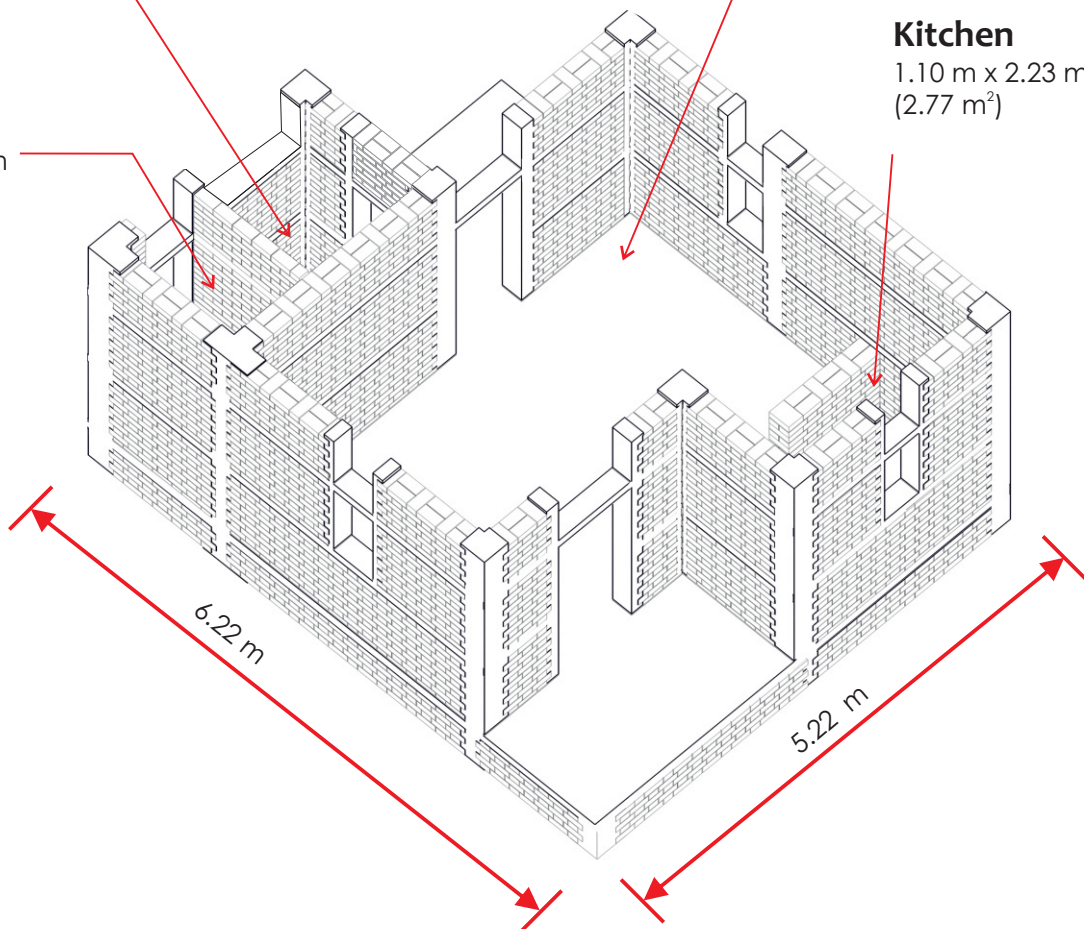

# Option 3

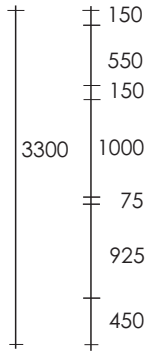

Brick Masonry Courses

**Front Elevation**

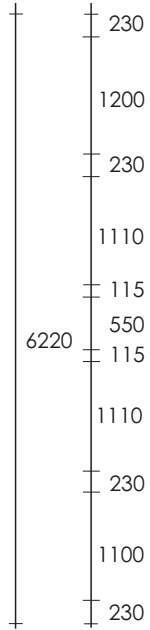
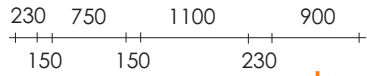

↑  
**A**

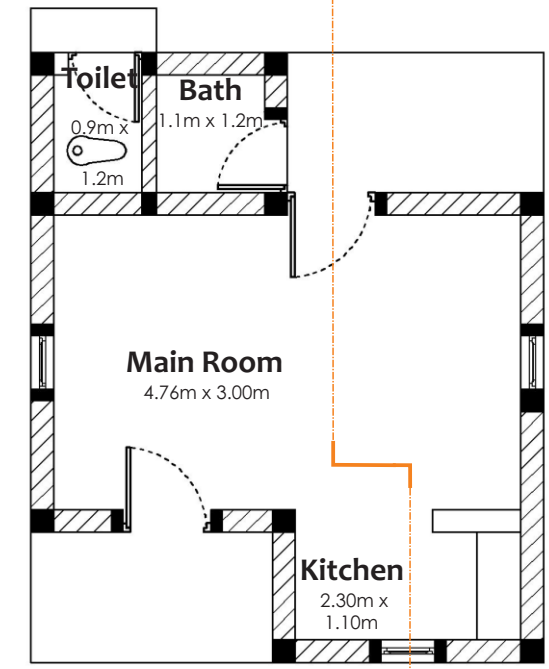

↑  
**A**

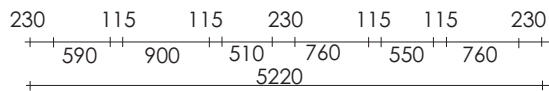

**Plan**

# Option 3

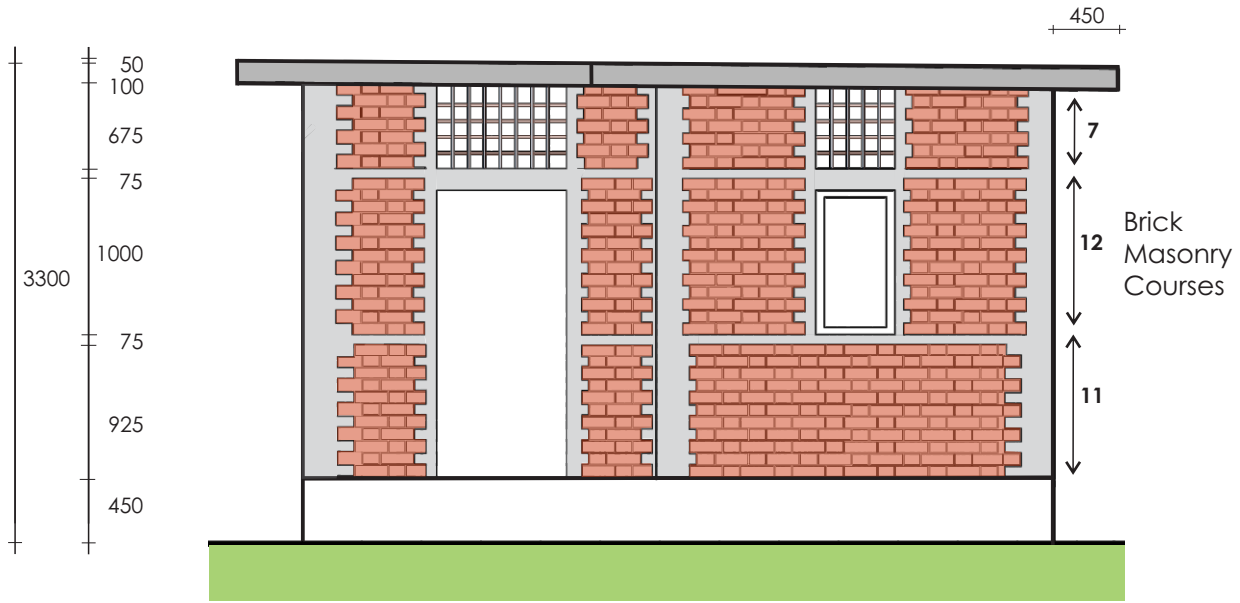

Front Elevation

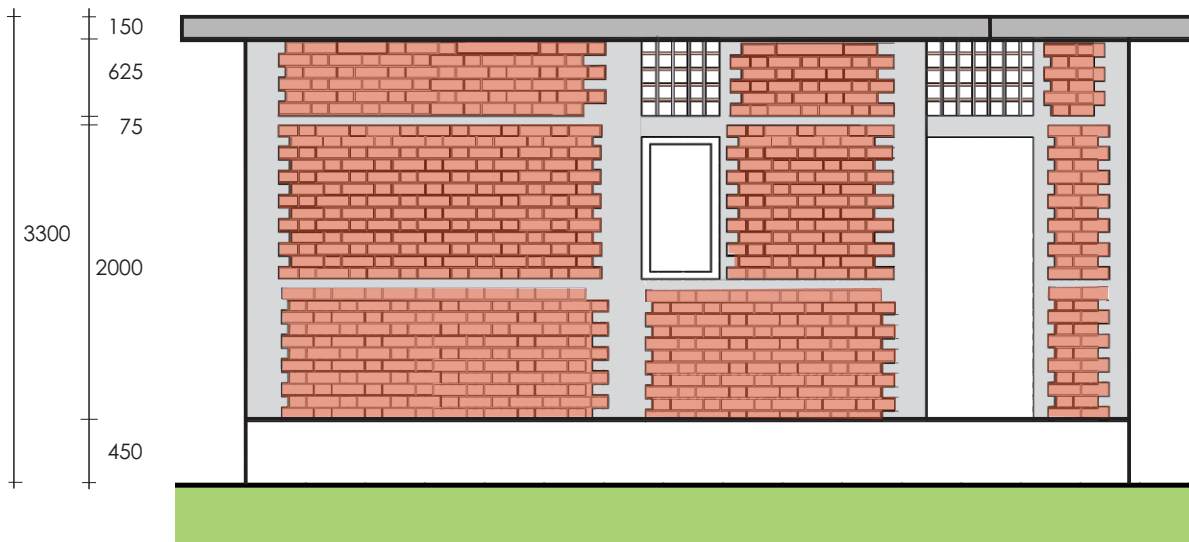

Right Elevation

# Option 3

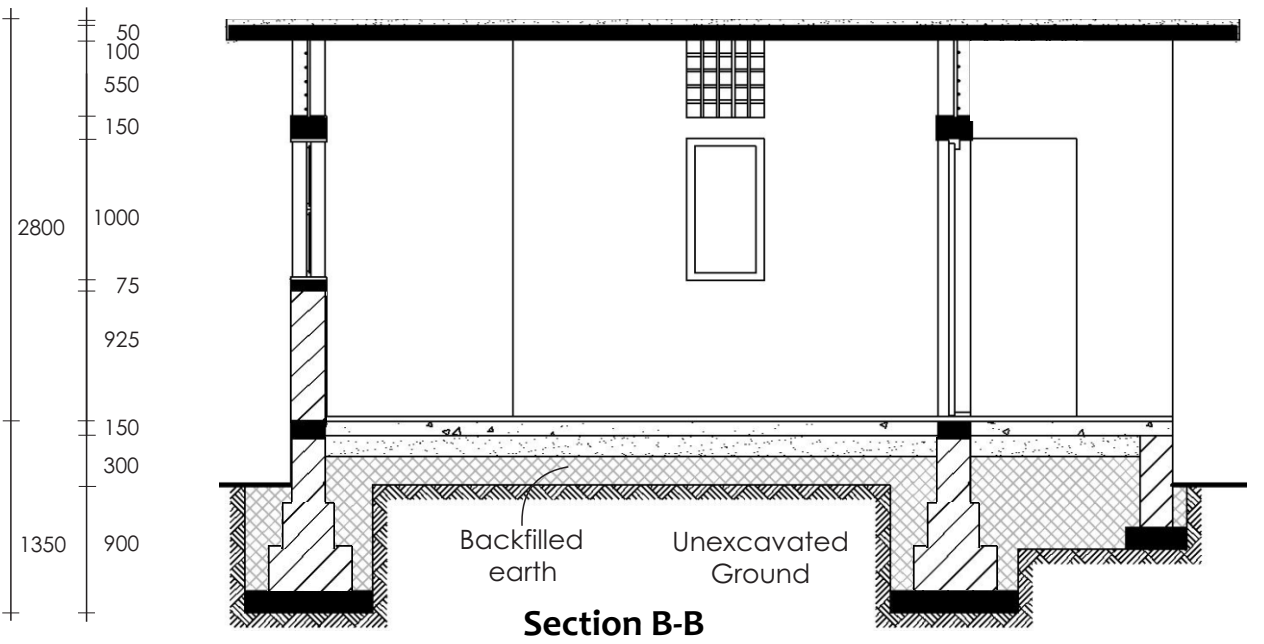
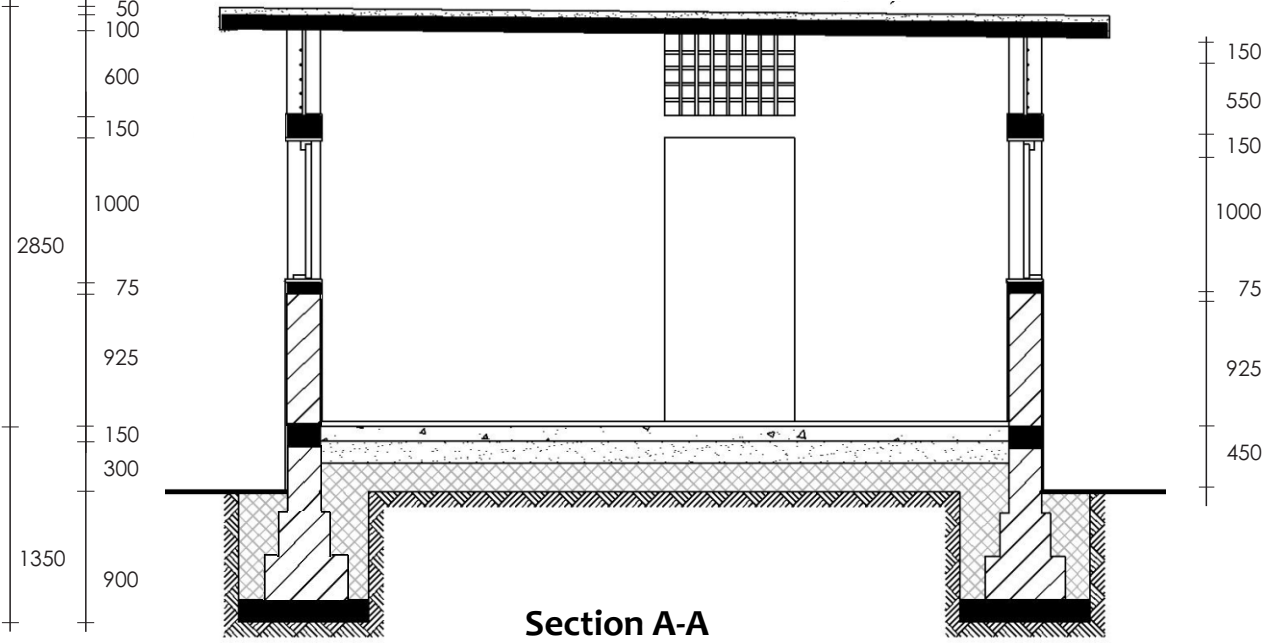

## Option 3

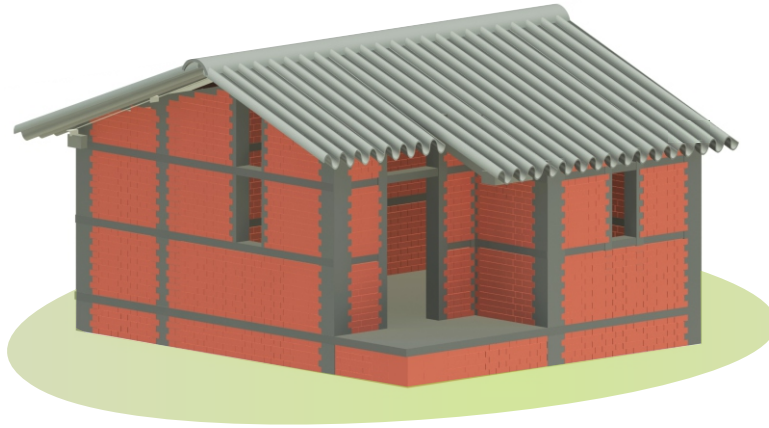

House with sloping roof

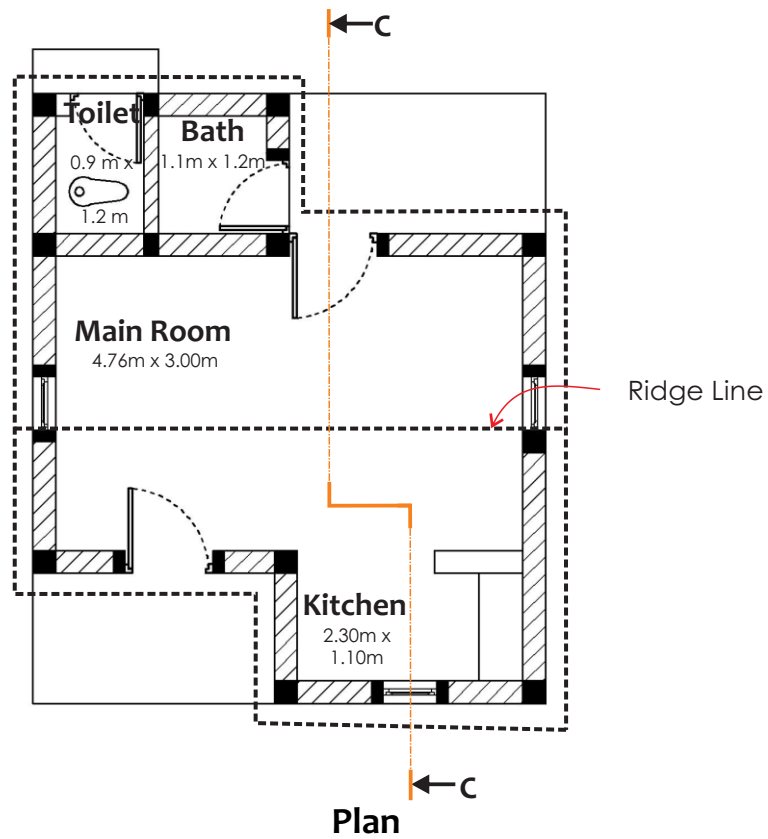

# Option 3



Front Elevation

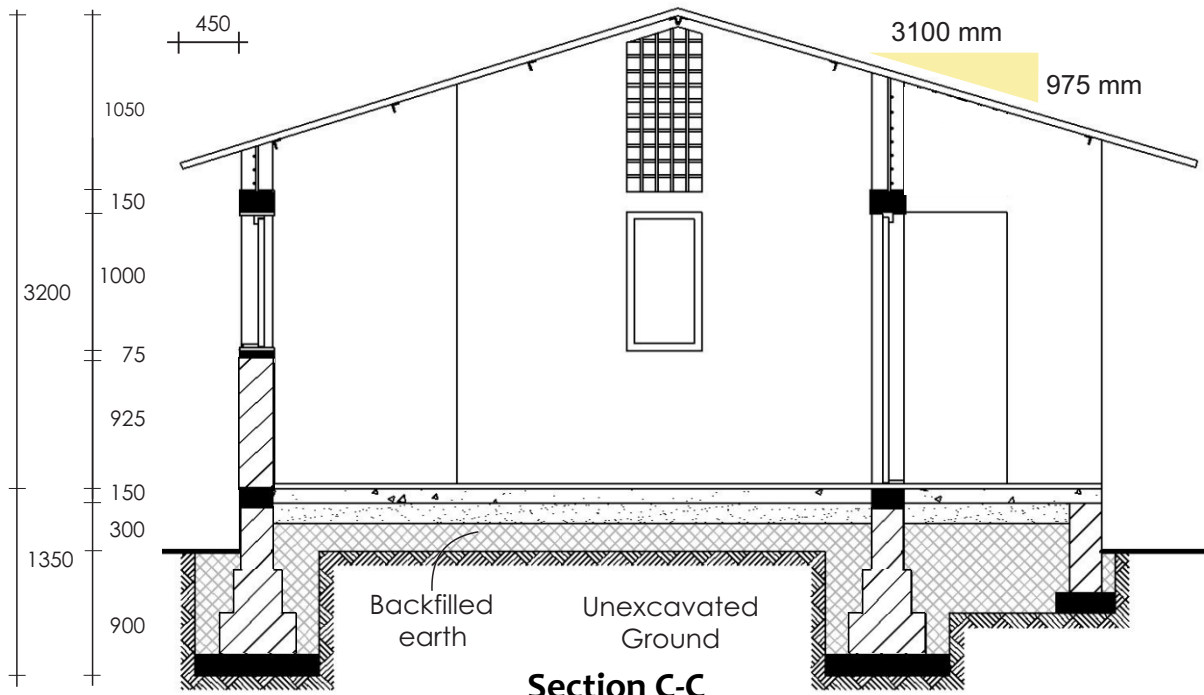

Section C-C

## Option 3 Extended

### How to extend my house ?

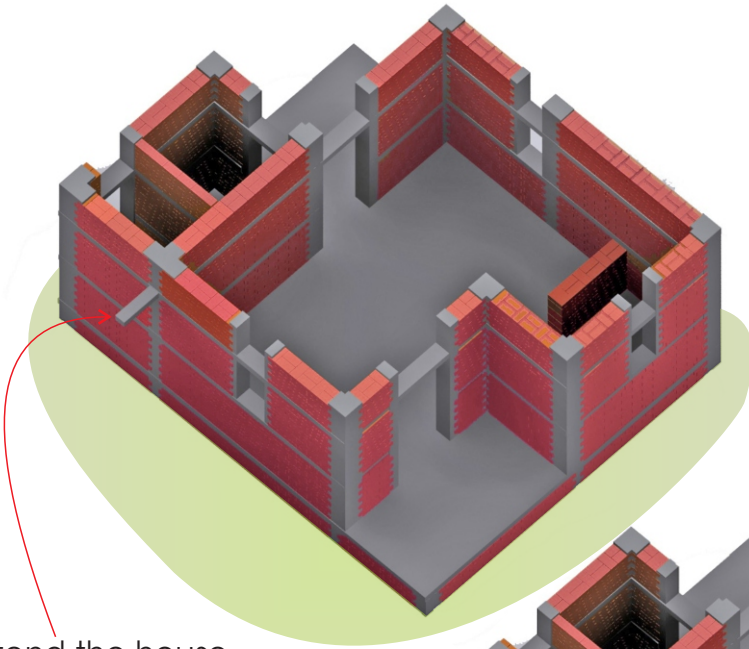

To extend the house, leave a projection of 600mm from the Lintel Band in the direction of proposed extension

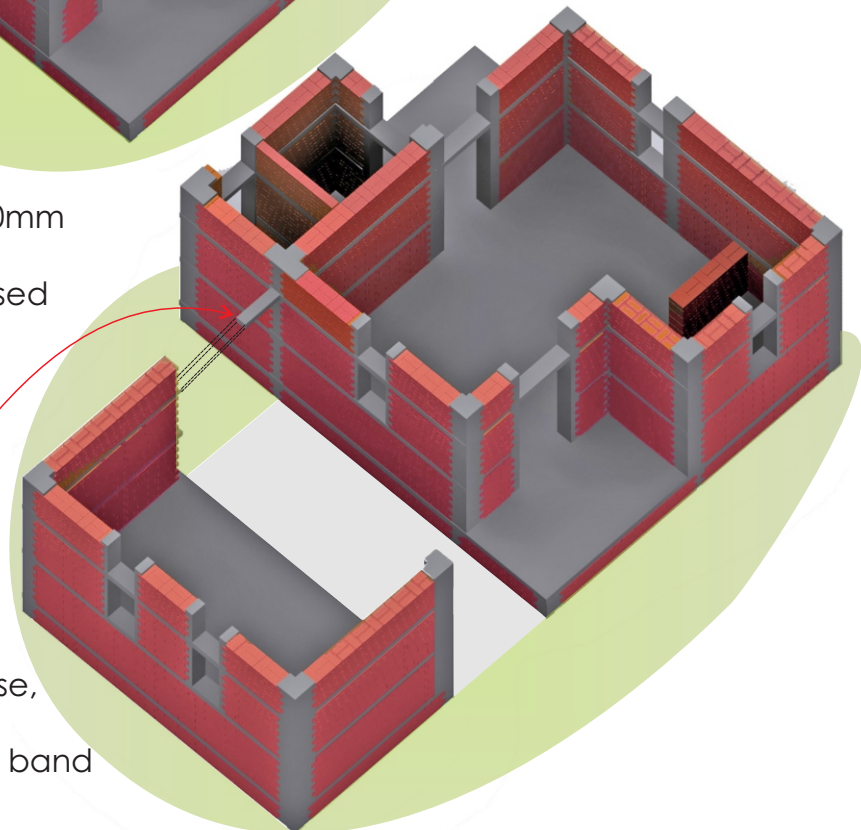

While extending the house, chip only the concrete from the projected lintel band left for future expansion

# Option 3 Extended

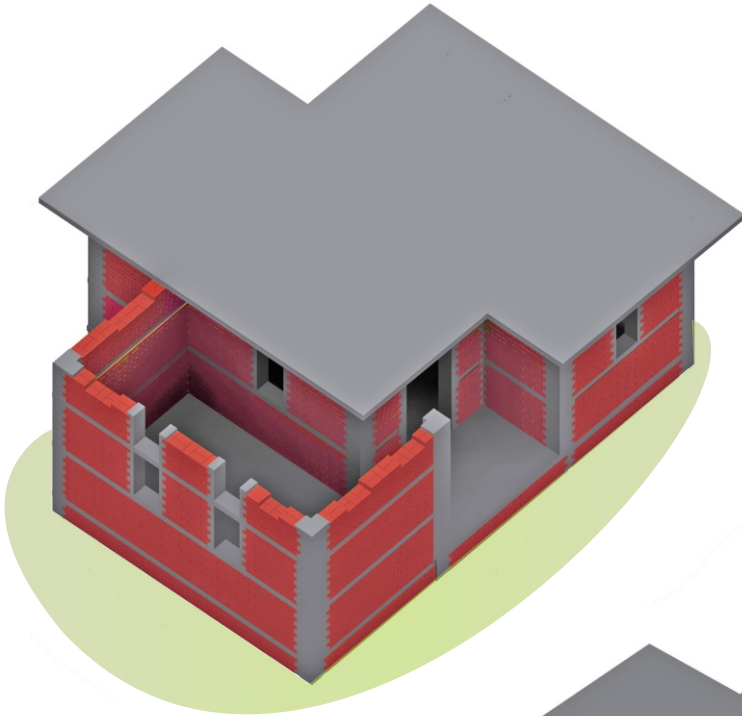

**Option 3 Extended**  
Built-up area: 47.94 m<sup>2</sup>  
Carpet area: 32.20 m<sup>2</sup>



# Option 3 Extended

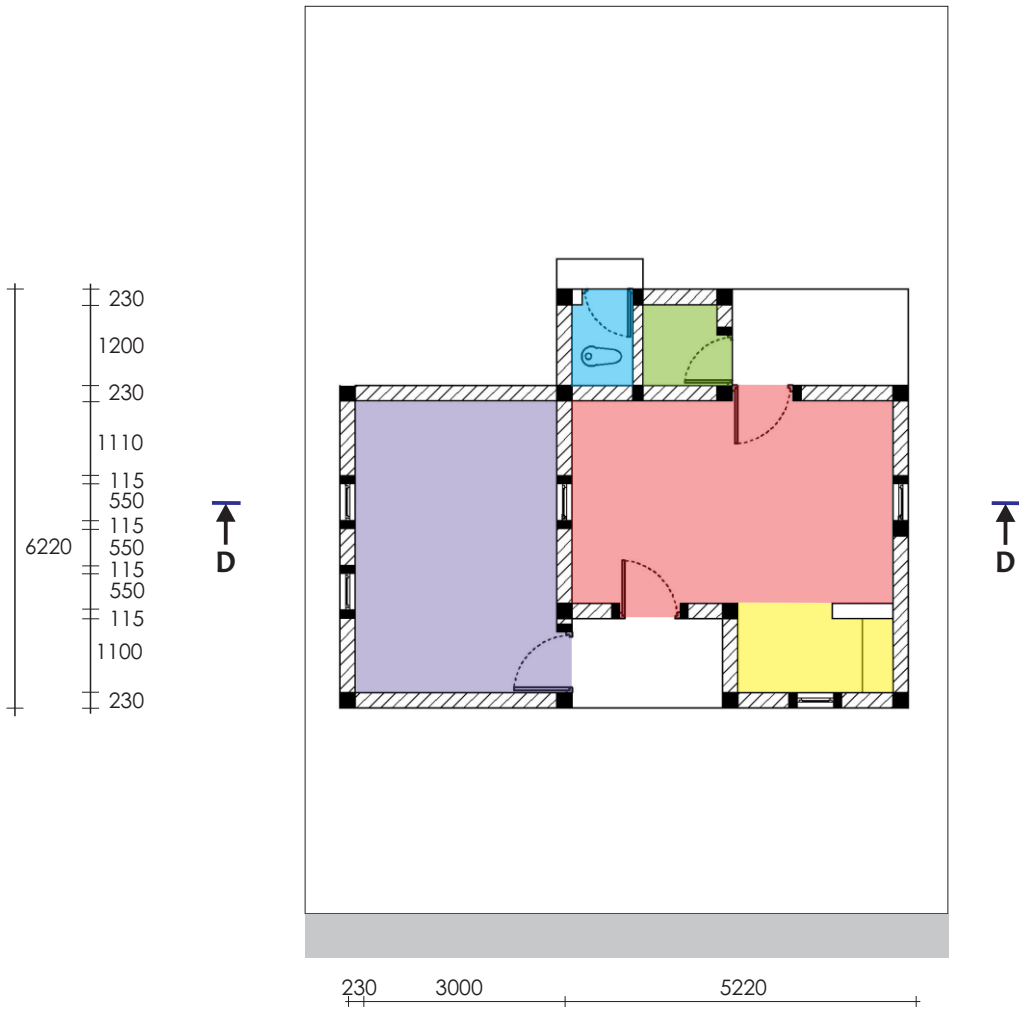

**Plan**



# Option 3 Extended

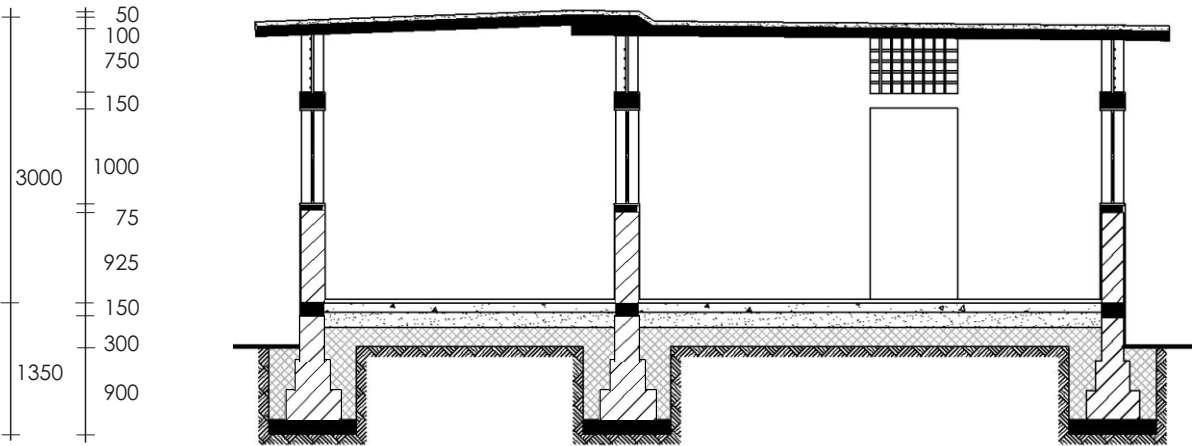

Section D-D

## Option 4

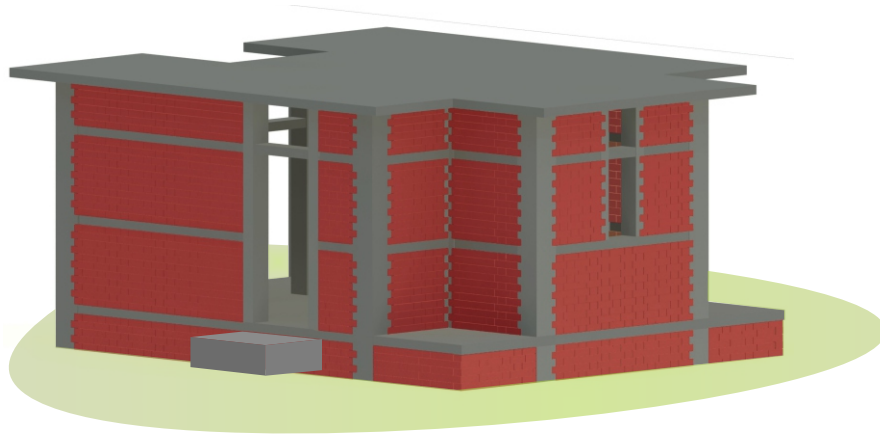

**Bath**  
1.2 m x 1.1 m  
(1.32 m<sup>2</sup>)

**Toilet**  
1.2 m x 0.9 m  
(1.08 m<sup>2</sup>)

**Main Room**  
3.00 m x 4.69 m  
(14.54 m<sup>2</sup>)

**Kitchen**  
1.10 m x 2.23 m  
(2.77 m<sup>2</sup>)

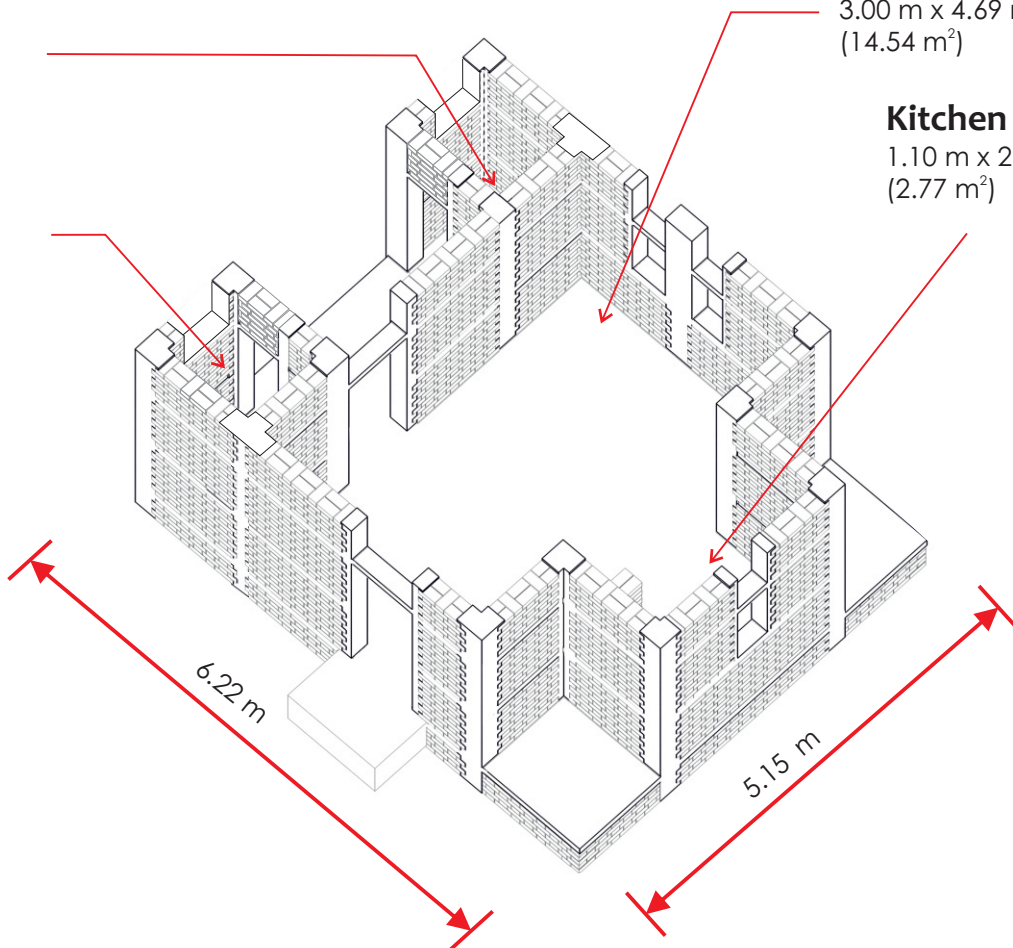

# Option 4

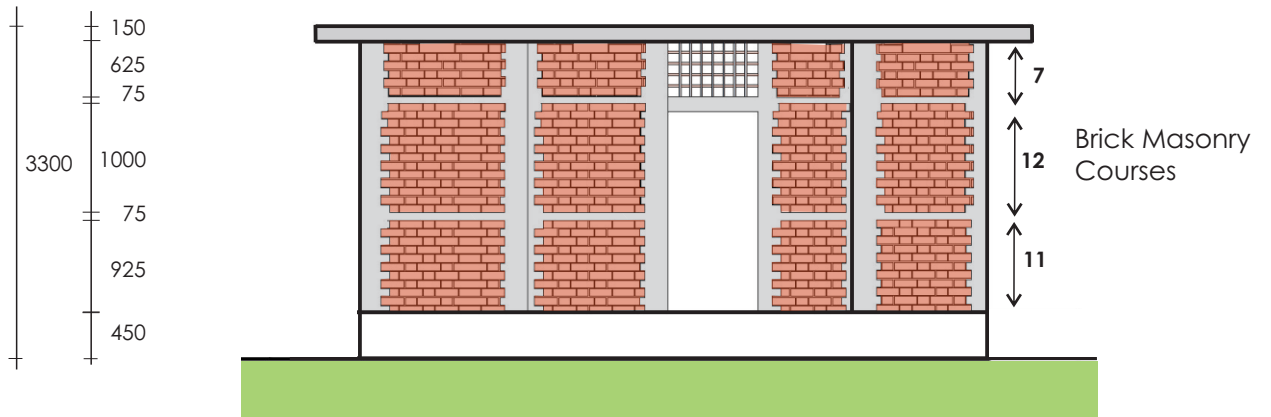

Front Elevation

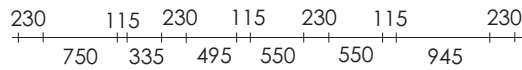

←B

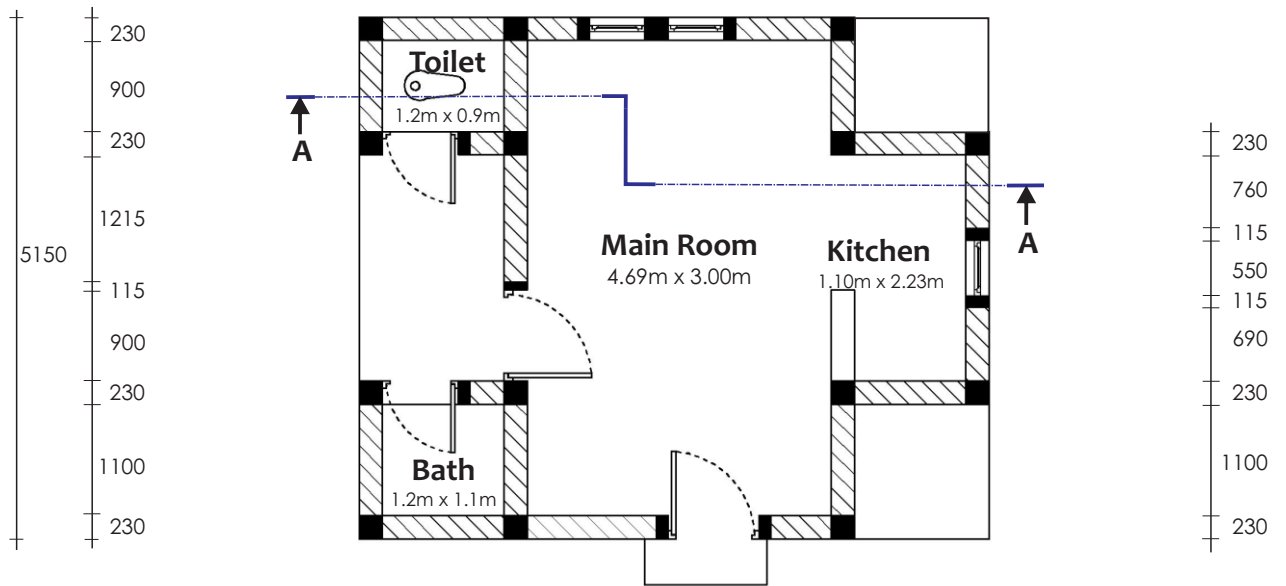

←B

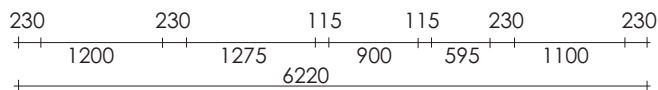

Plan

# Option 4

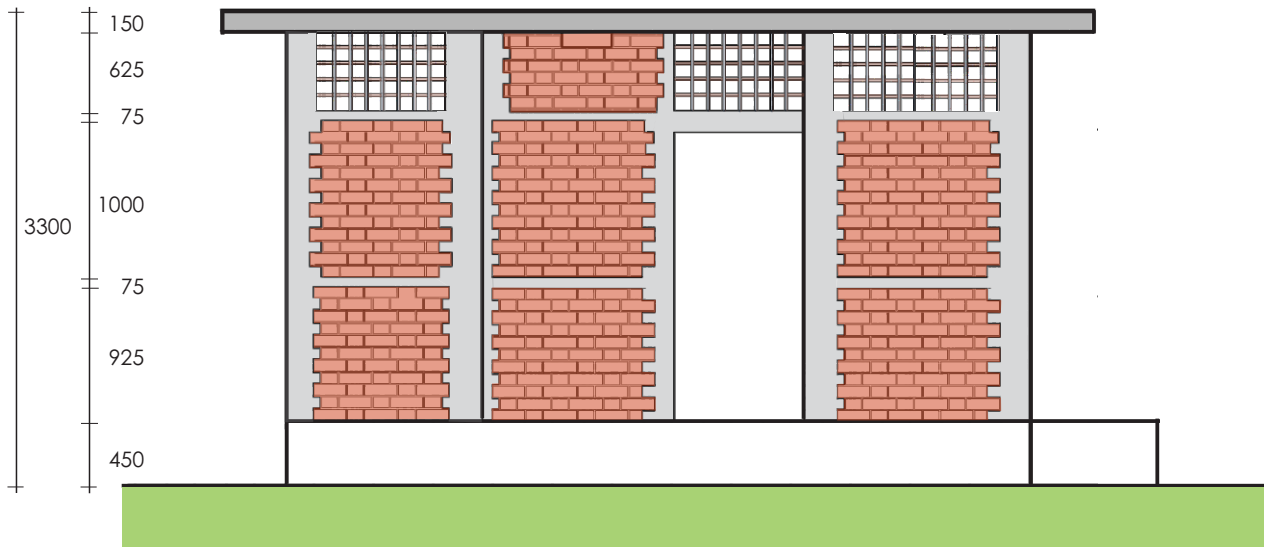

Left Elevation

# Option 4

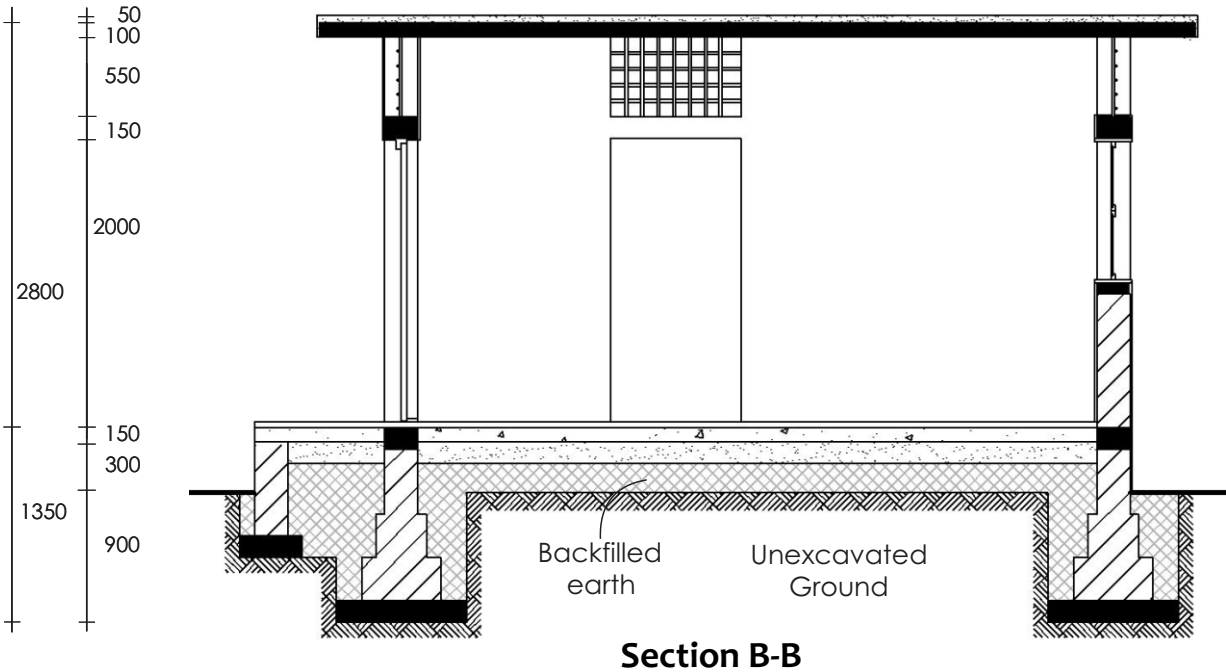
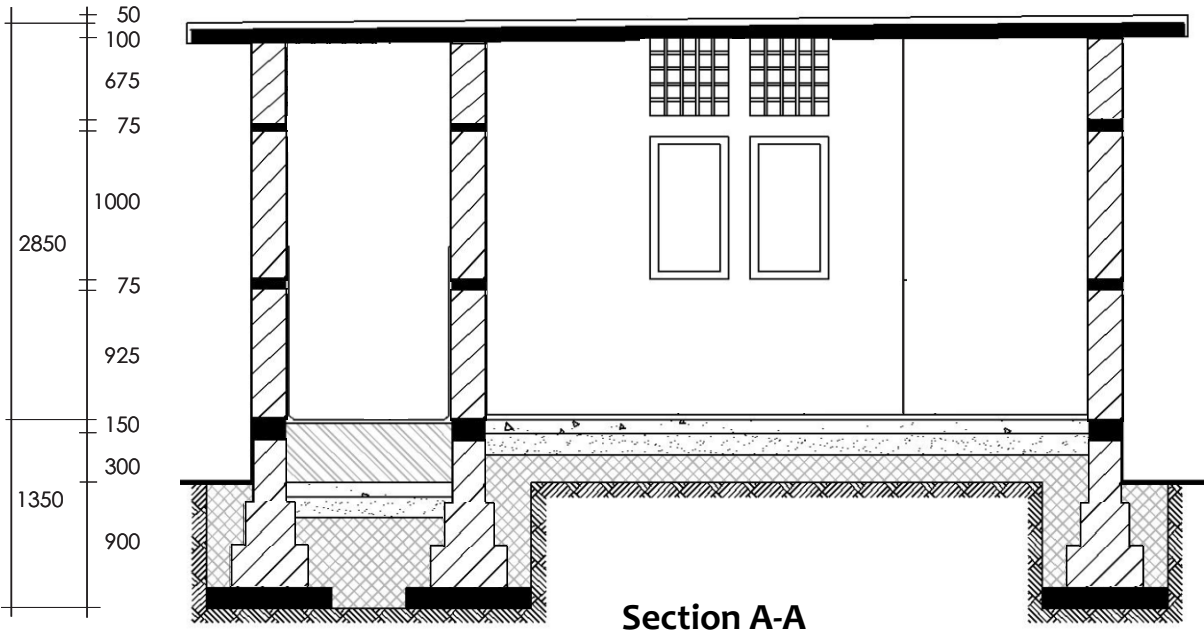

## Option 4

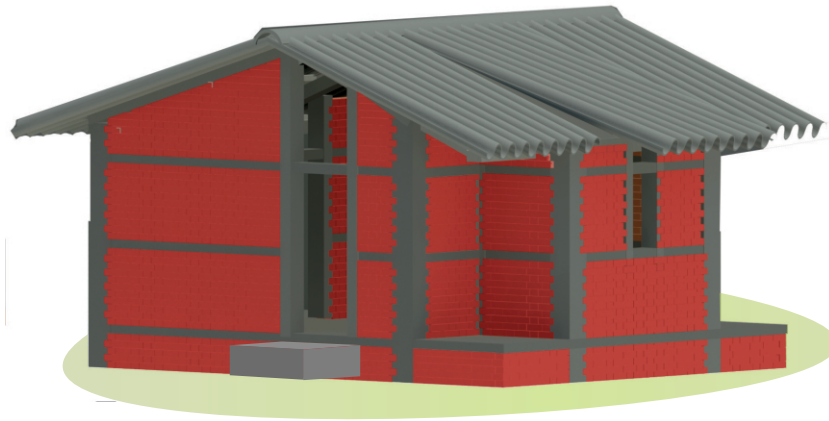

House with sloping roof

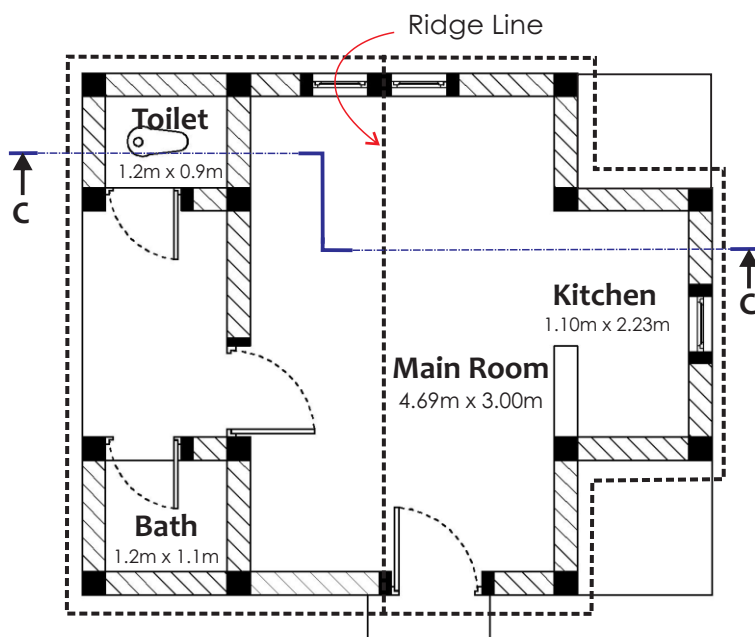

Plan

# Option 4

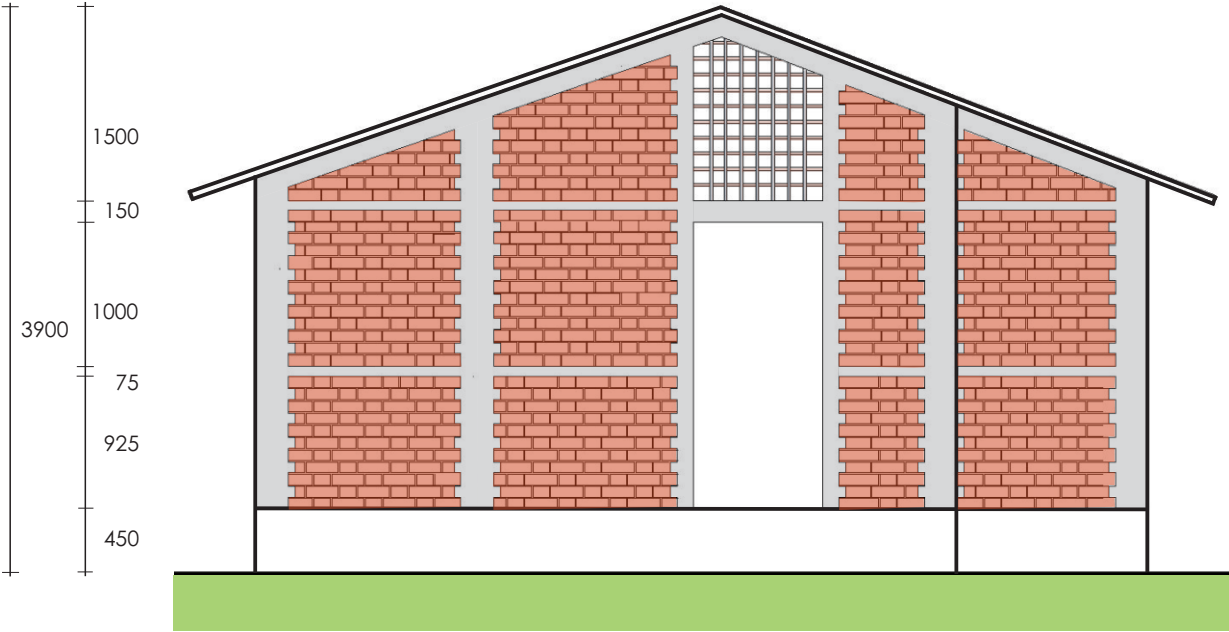

Front Elevation

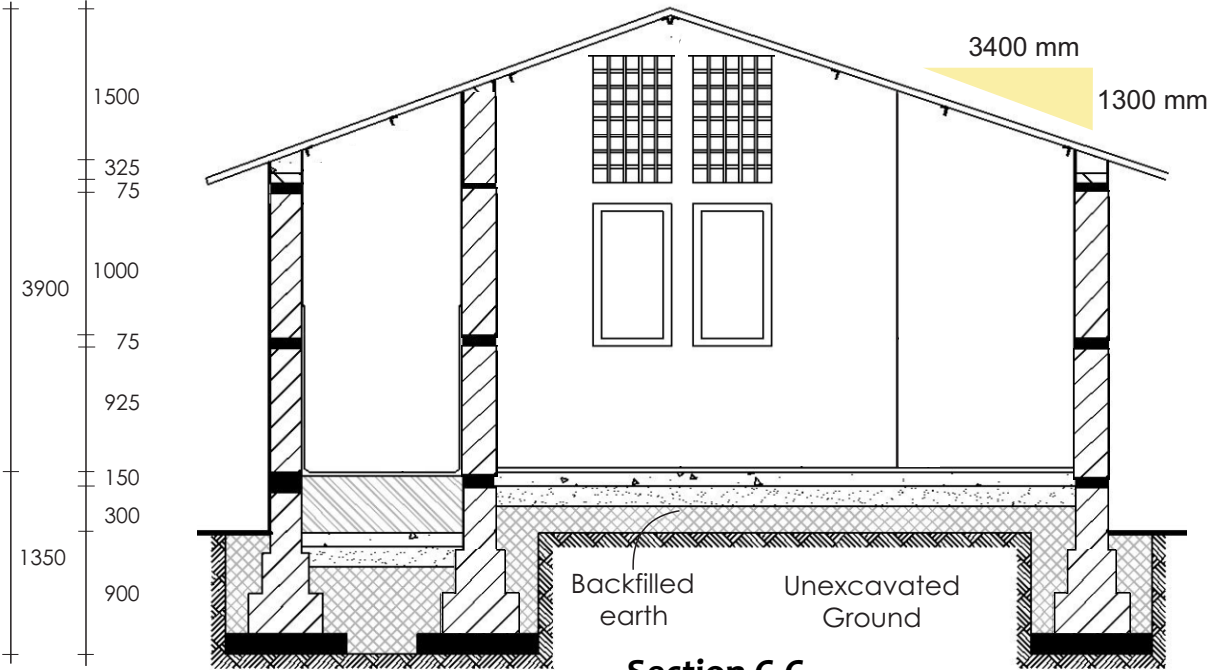

Section C-C

## Option 4 Extended

### How to extend my house ?

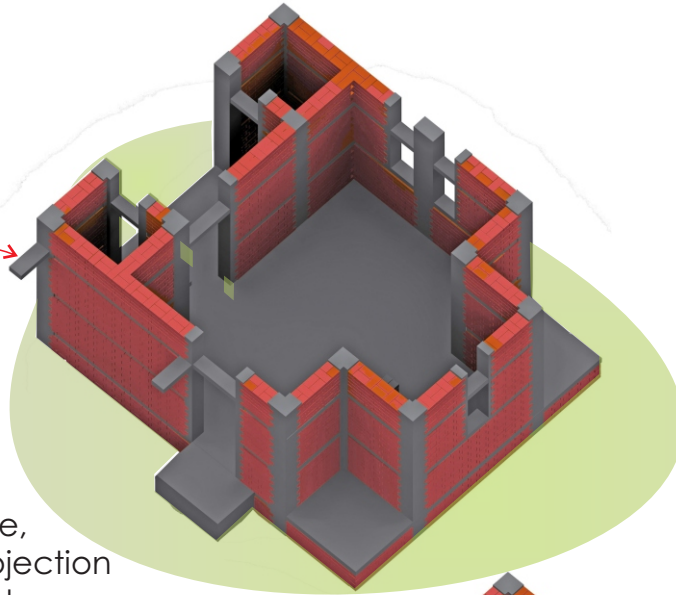

To extend the house, leave a 600mm projection from the Lintel Band in the direction of proposed expansion

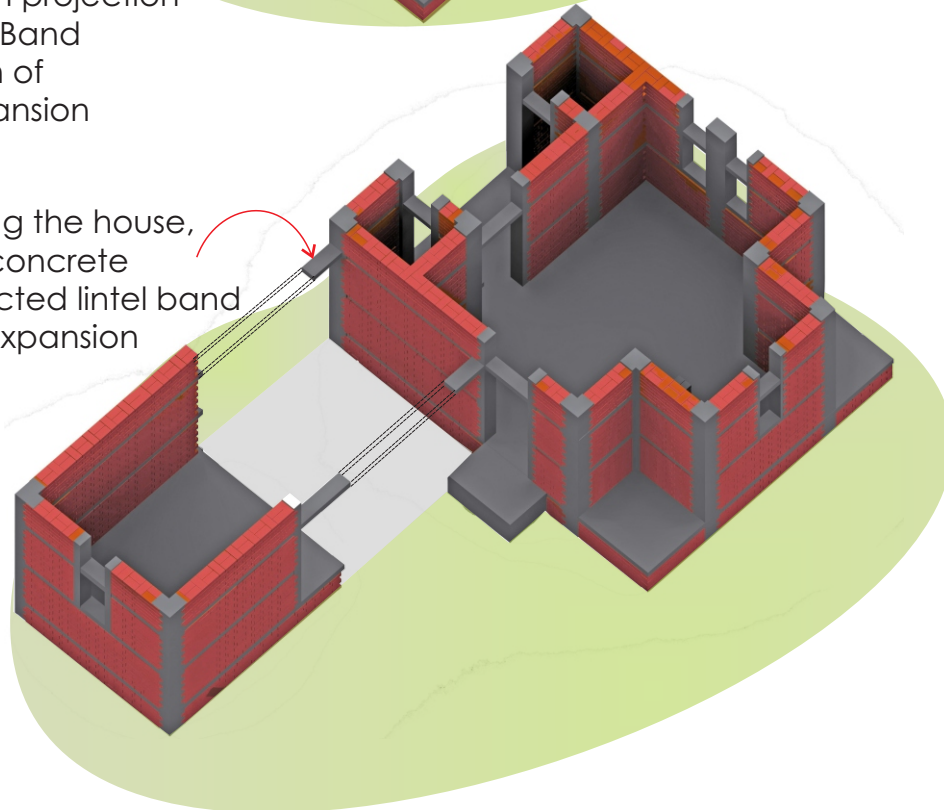

While extending the house, chip only the concrete from the projected lintel band left for future expansion

# Option 4 Extended

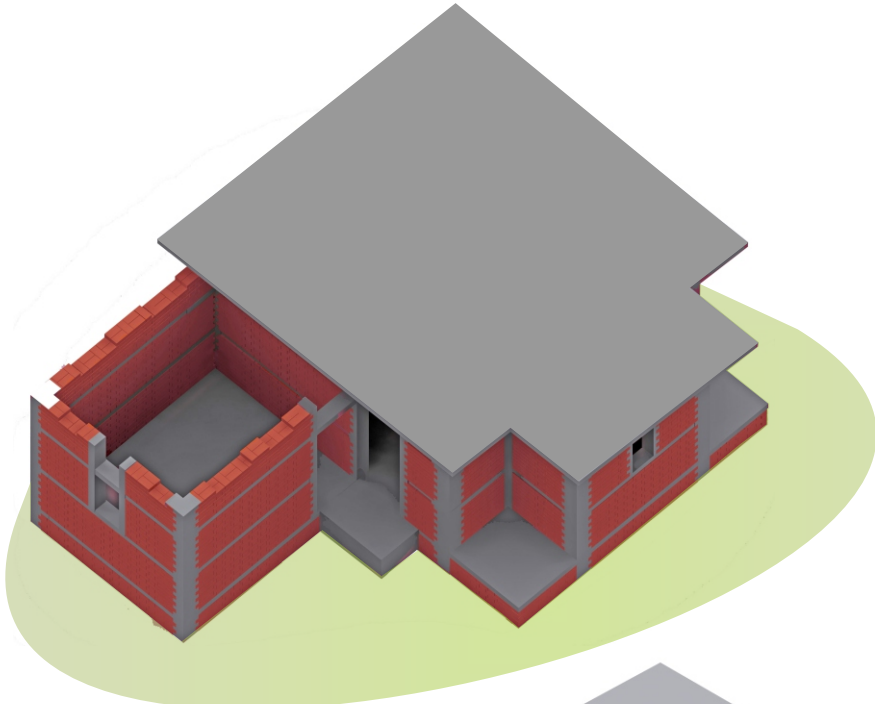

**Option 4 Extended**  
Built-up area: 40.38 m<sup>2</sup>  
Carpet area: 26.69 m<sup>2</sup>

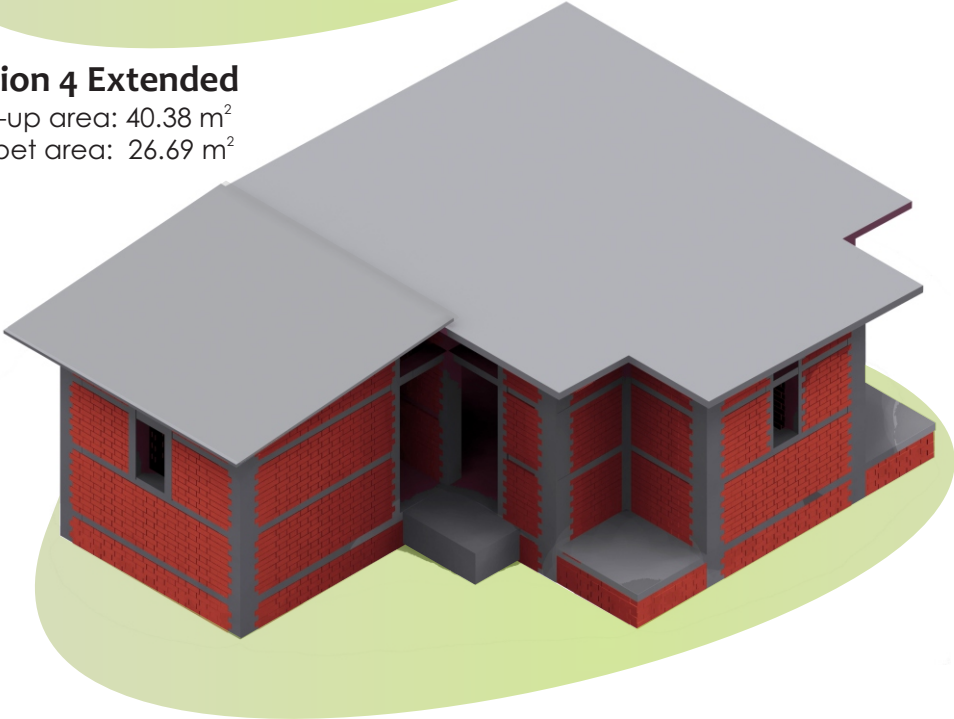

# Option 4 Extended

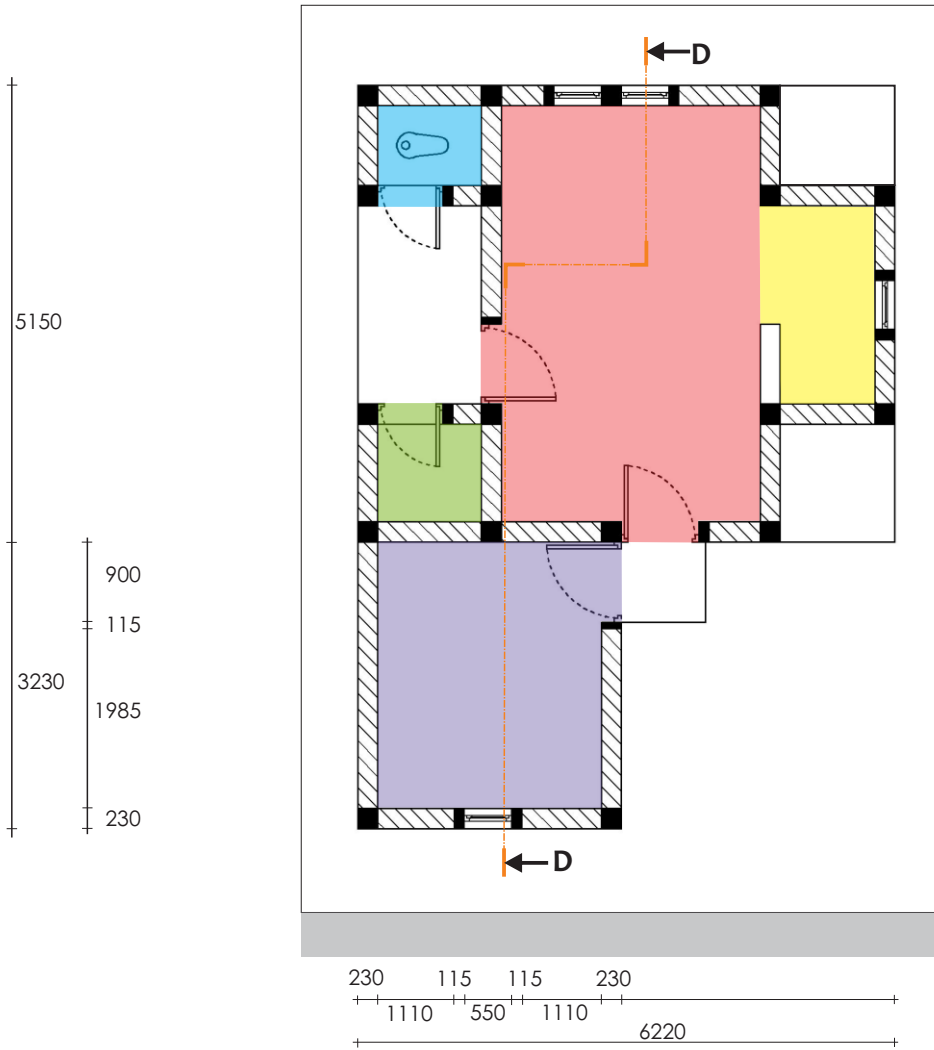

**Plan**



# Option 4 Extended

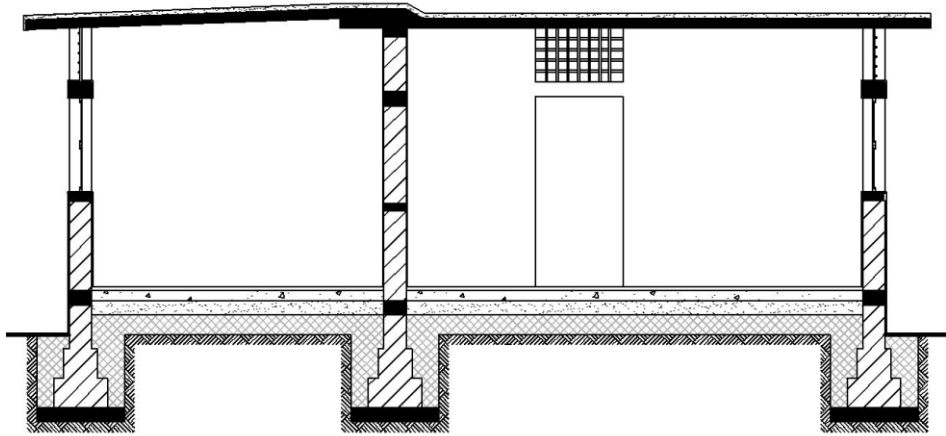
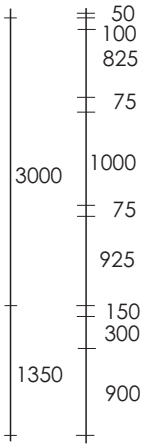

Section D-D

## Option 5

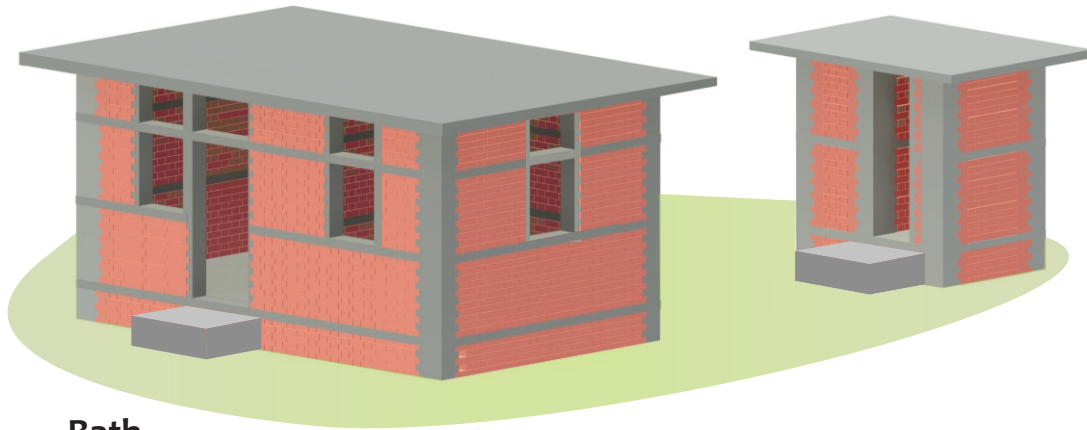

**Bath**  
1.2 m x 1.1 m  
(1.32 m<sup>2</sup>)

**Toilet**  
1.2 m x 0.9 m  
(1.08 m<sup>2</sup>)

**Main Room**  
4.20 m x 3.00 m  
(14.54 m<sup>2</sup>)

**Kitchen**  
1.20 m x 3.00 m  
(2.77 m<sup>2</sup>)

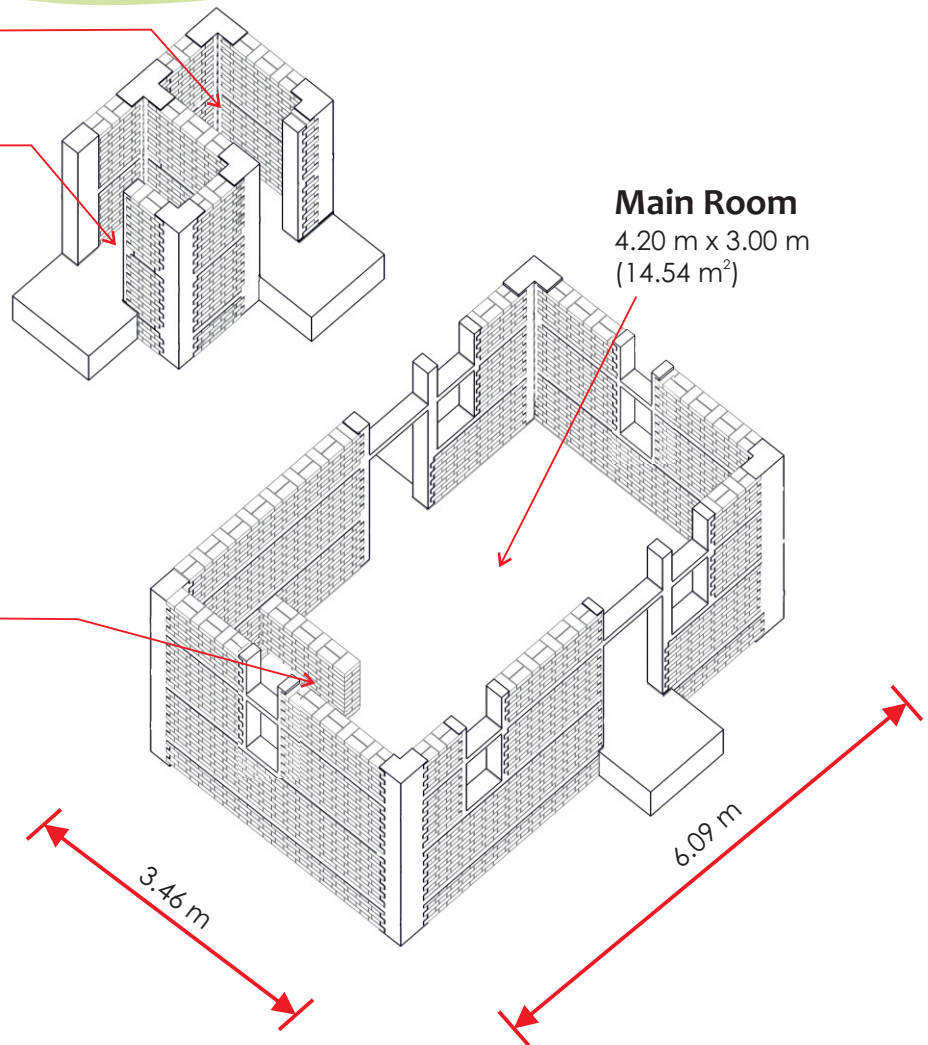

# Option 5

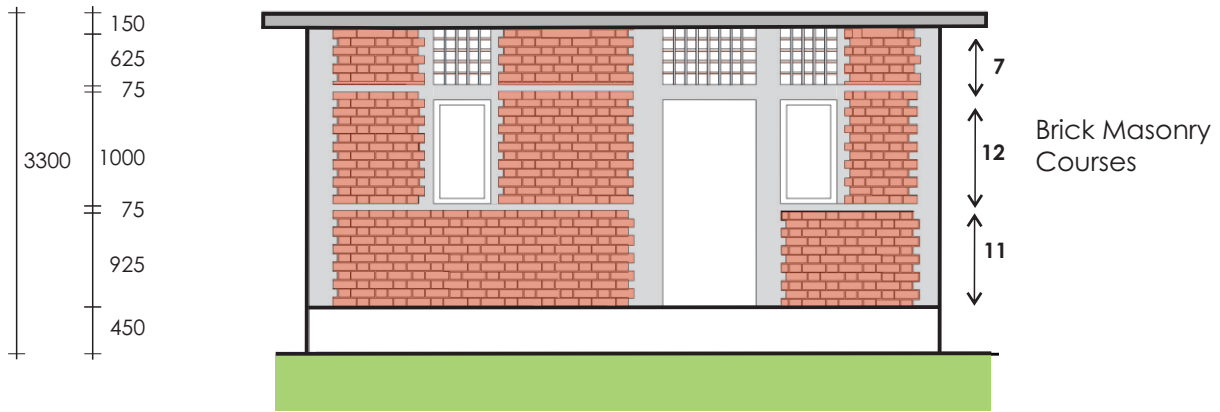

**Front Elevation**

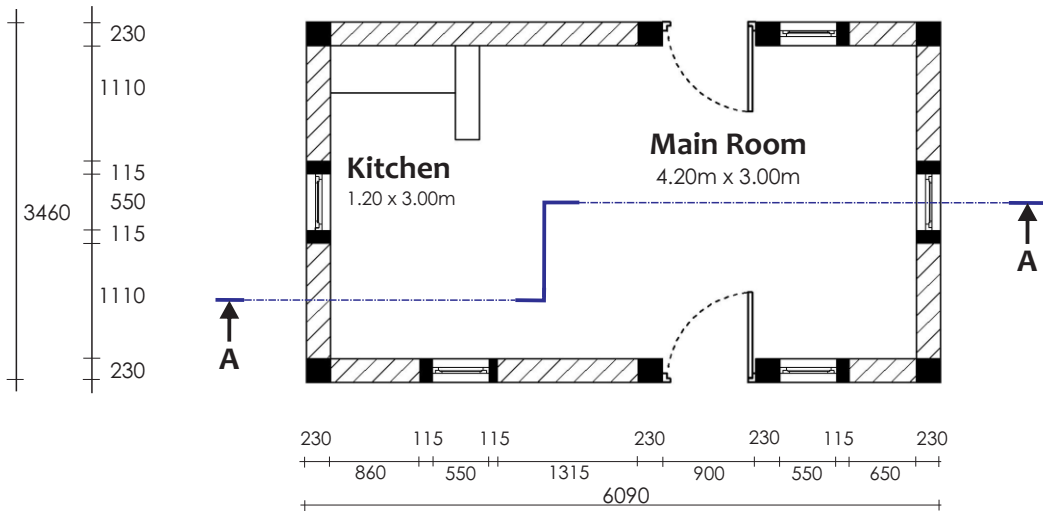
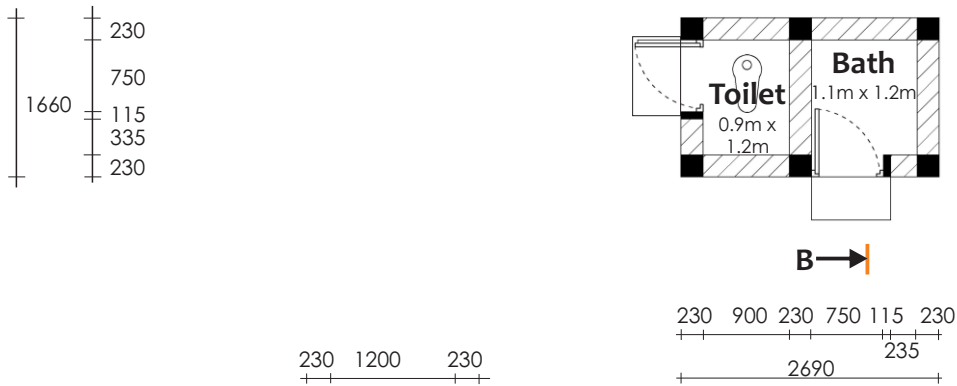

**Plan**

# Option 5

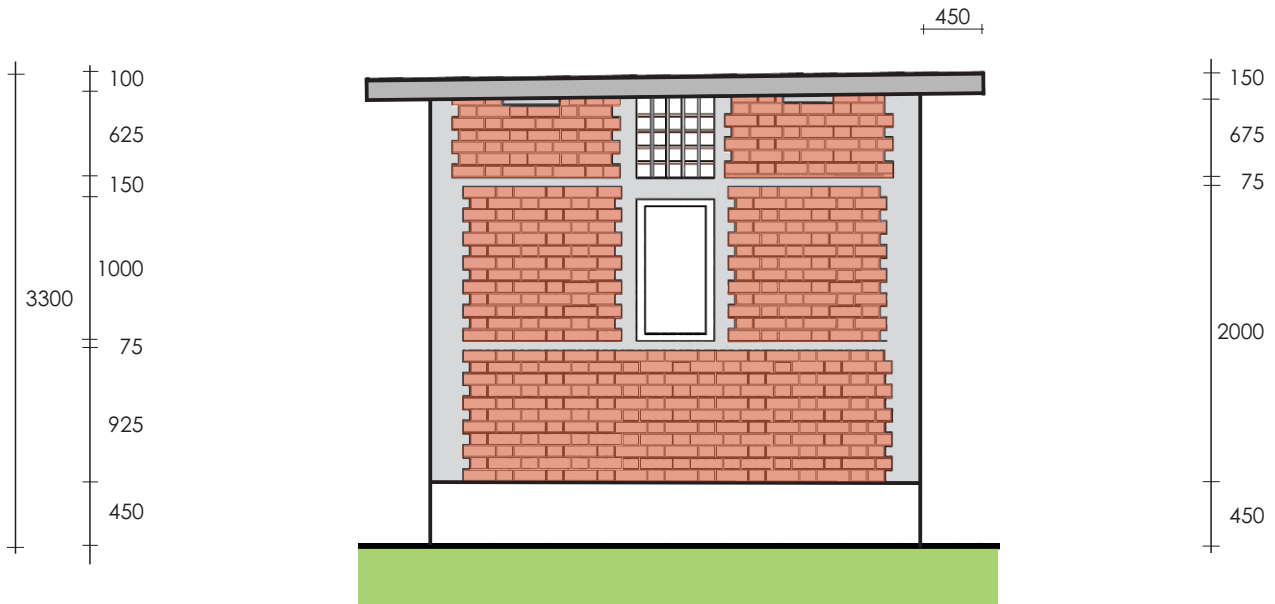

**Right Elevation**

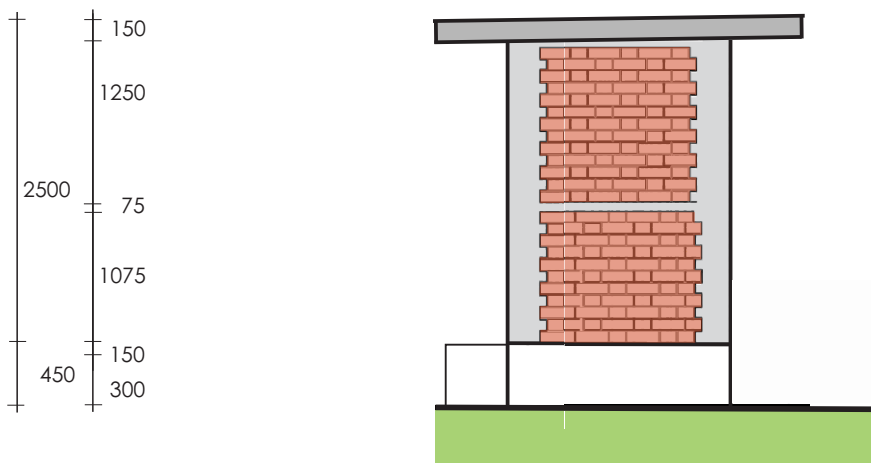

**Left Elevation of Toilet**

# Option 5

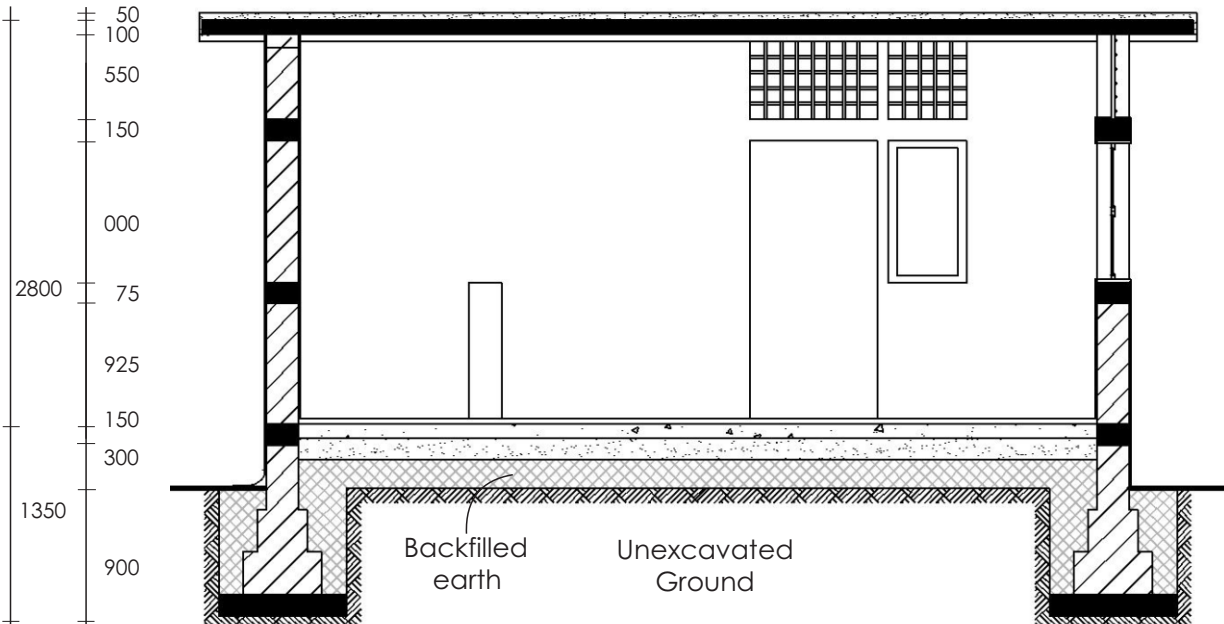

**Section A-A**

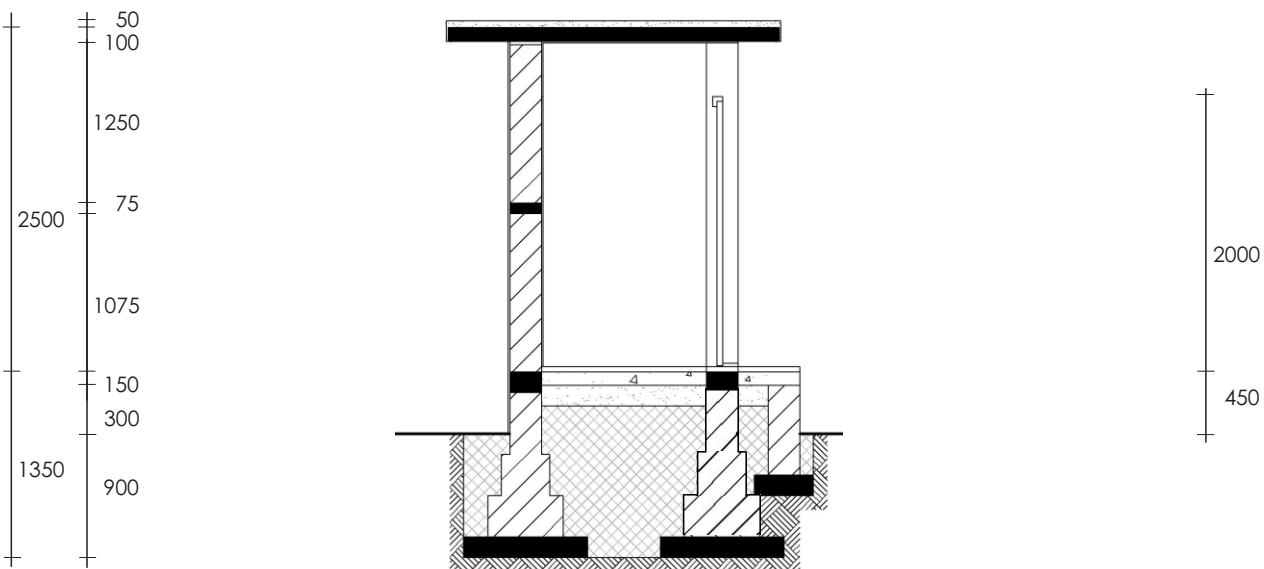

**Section B-B**

# Option 5

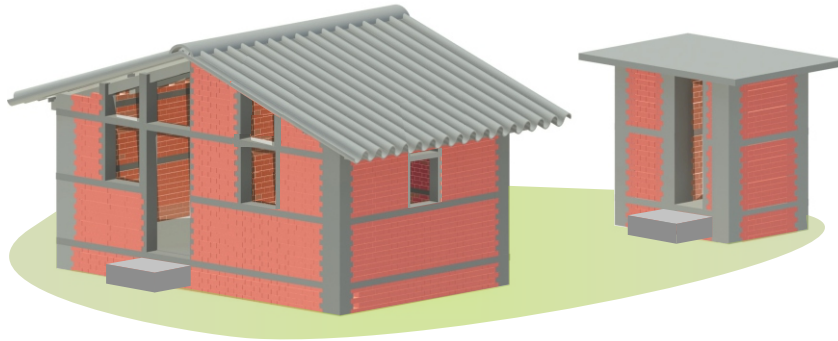

House with sloping roof

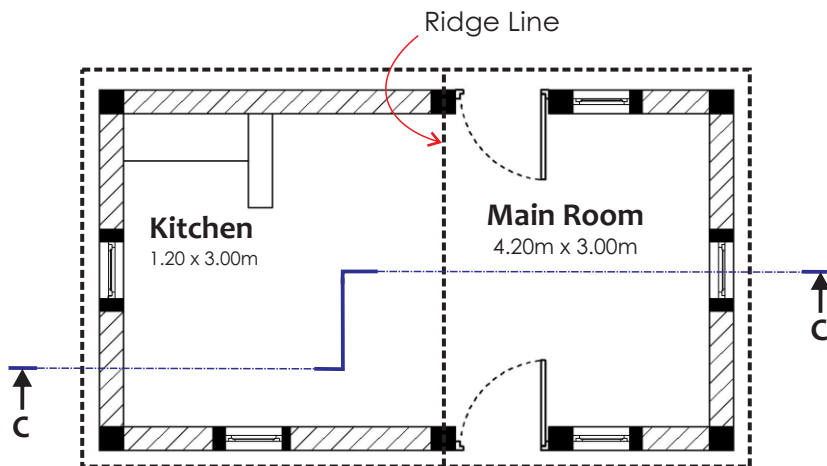
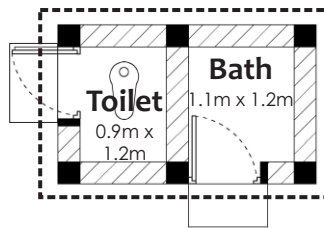

Plan

# Option 5

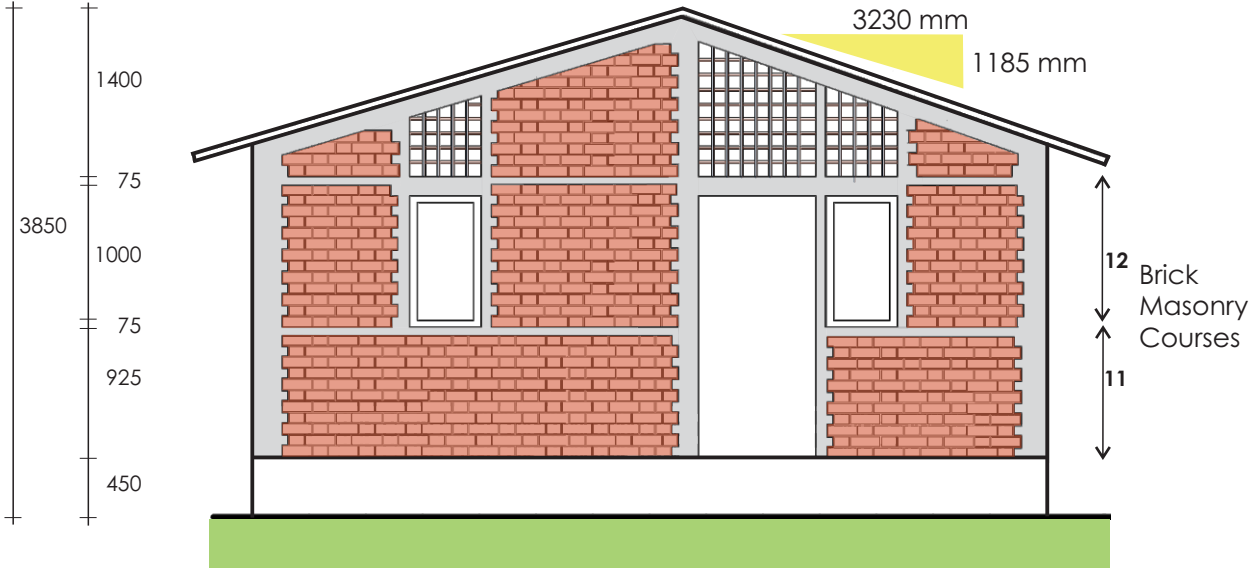

**Front Elevation**

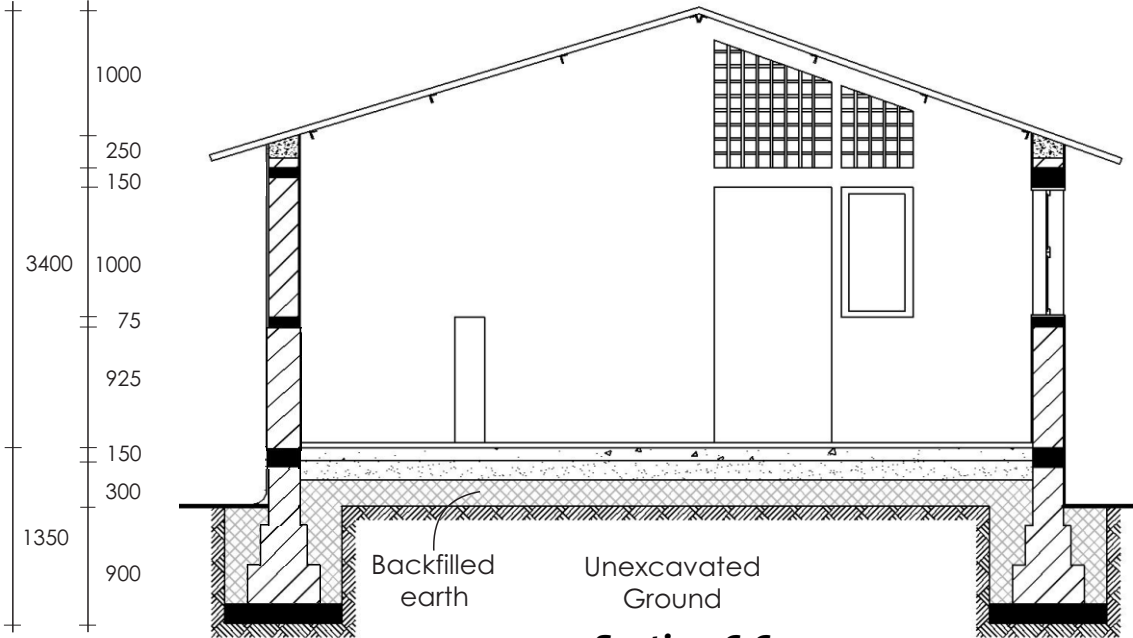

**Section C-C**

## Option 5 Extended

### How to extend my house ?

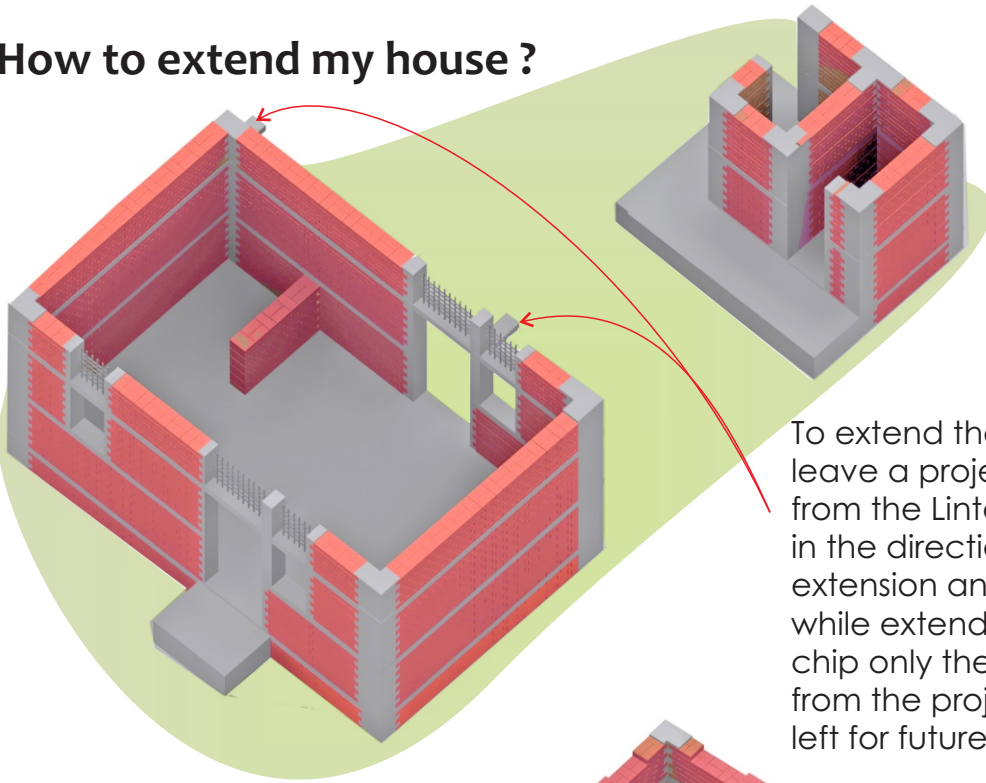

To extend the house, leave a projection of 600mm from the Lintel Band in the direction of proposed extension and while extending the house, chip only the concrete from the projected lintel band left for future expansion

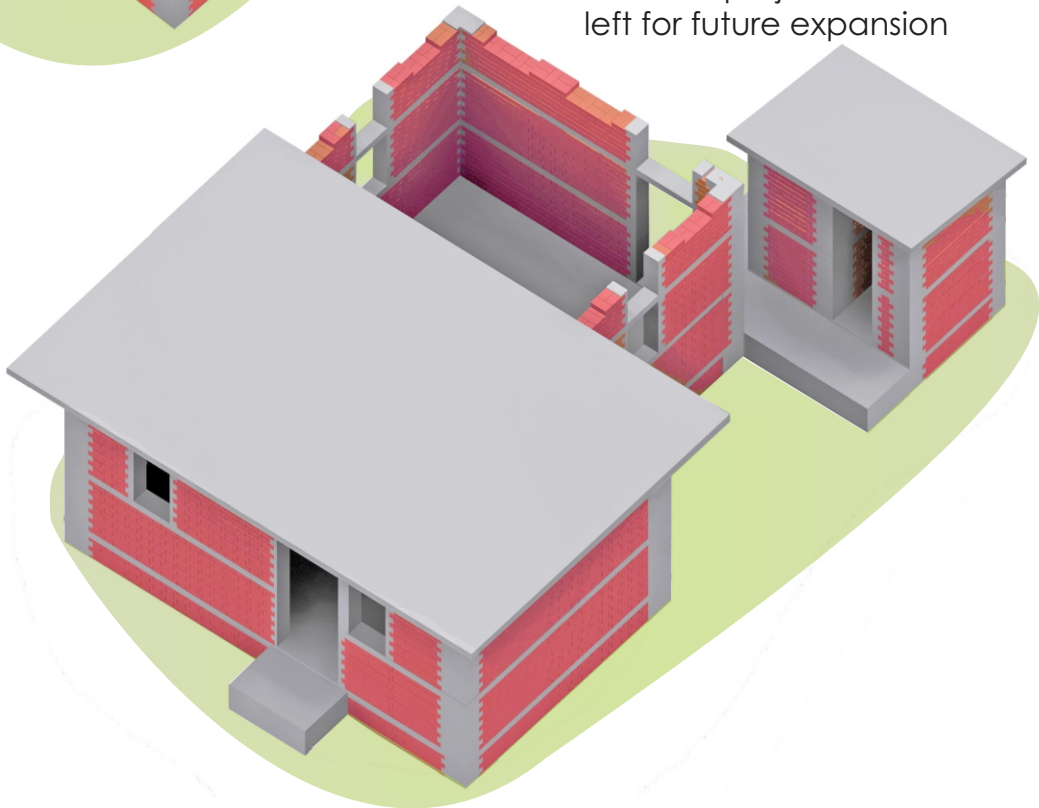

## Option 5 Extended

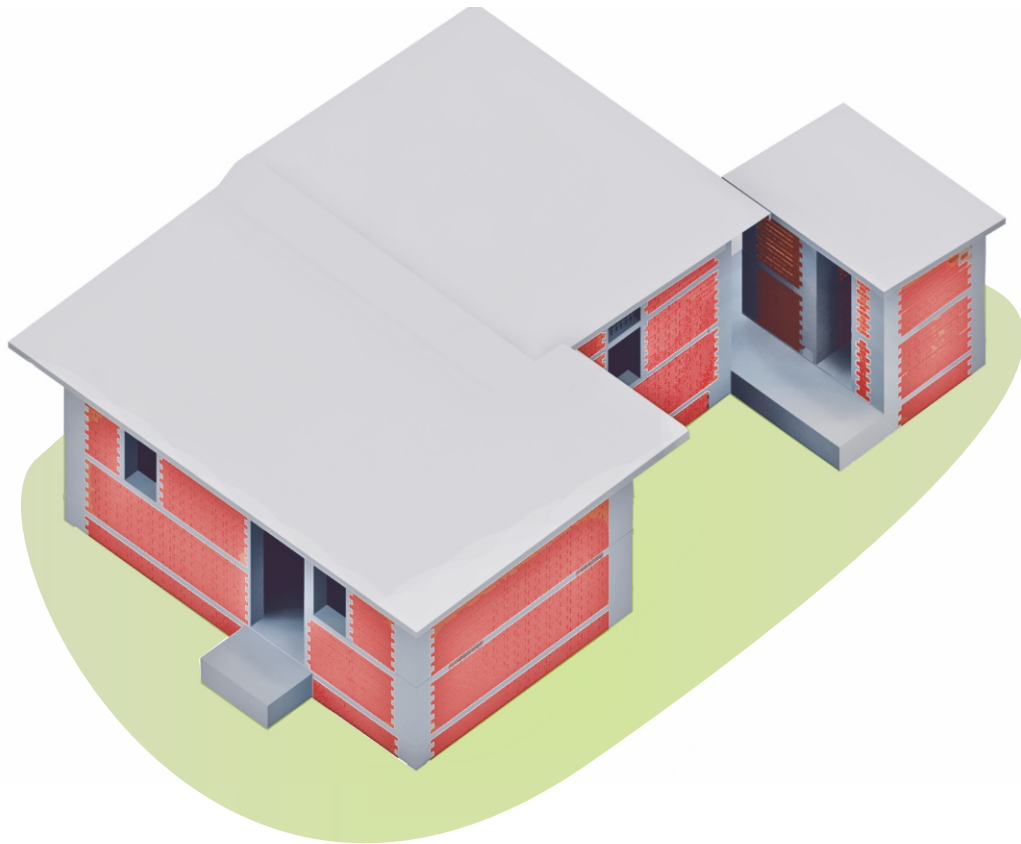

### Option 5 Extended

Built-up area: 40.22 m<sup>2</sup>

Carpet area: 30.86 m<sup>2</sup>

# Option 5 Extended

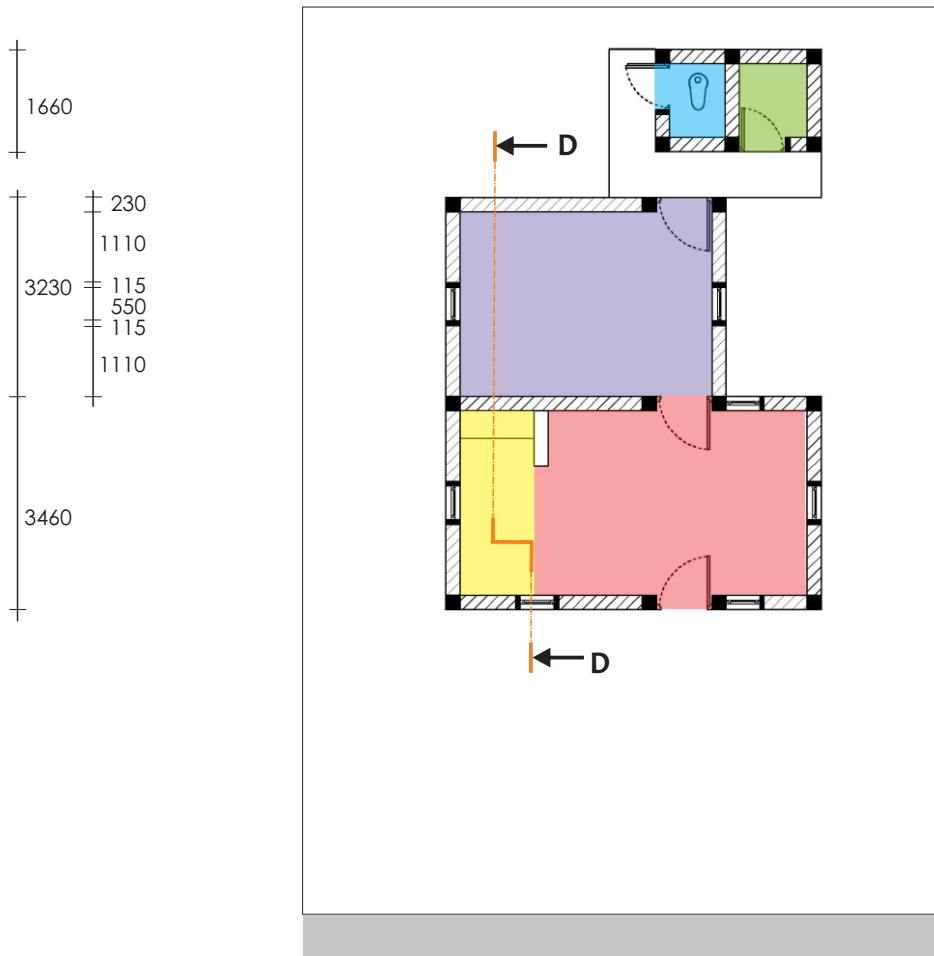

Plan



# Option 5 Extended

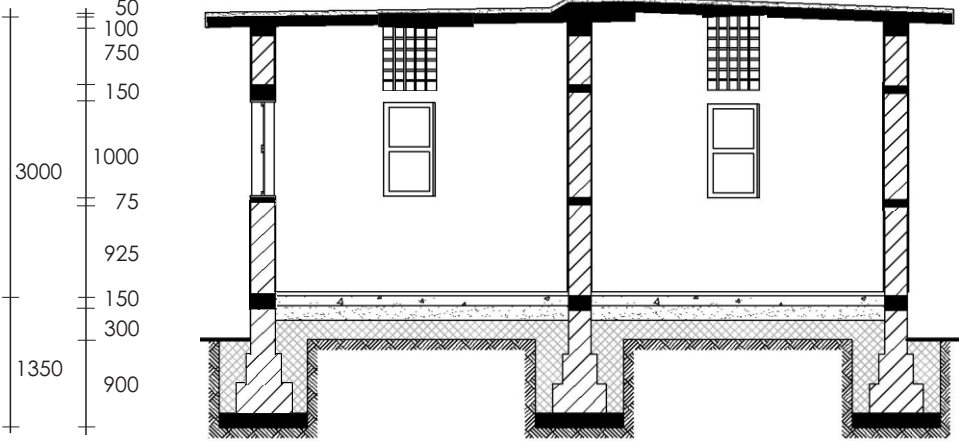

Section D-D



# **Basics of Construction**



# What basic materials are required to build my house ?



## Cement

Grade 33 cement is required in foundation and plinth (in plain concrete mat, and flooring), walls (in mortar, RC bands and RC vertical elements) and roof (reinforced concrete).



## Sand

Well graded clean river sand is required in foundation and plinth (in plain concrete mat, plinth fill, and flooring), walls (in mortar, RC bands and RC vertical elements) and roof (reinforced concrete).



## Aggregate

Well graded 20mm down stone aggregate is required in foundation and plinth (in plain concrete mat, and flooring), walls (in RC bands and RC vertical elements) and roof (reinforced concrete).



## Steel

Steel reinforcing bars of two types are required, namely high yield strength ribbed bars of 10mm diameter and mild steel smooth bars of 6mm diameter. It is required in walls (in RC bands and RC vertical elements) and roof (reinforced concrete).



## Masonry Units

Masonry units can be burnt clay bricks, natural stone (that is dressed), fly ash bricks or cement blocks. It is required in foundation and plinth (in masonry) and walls (in masonry).



## Water

Clean potable water is required for all components of the house, namely foundation and plinth, walls and roof.

## Which masonry units can I use ?

Masonry walls/foundation using cement mortar can be built with following materials:

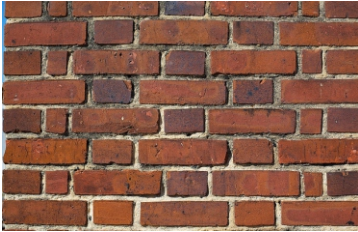

### **Burnt Clay Bricks**

Class B or better burnt clay bricks with compressive strength of at least 7-10 MPa. The size of the bricks considered are the standard brick available in India, namely of size 230mm × 115mm × 75mm.



### **Fly Ash Bricks**

Fly Ash bricks from nearby Thermal Power Plants with compressive strength of at least 7-10 MPa. The size of these units should be similar to that of the burnt clay bricks, namely 230 mm × 115 mm × 75 mm.



### **Sandstone Blocks**

Naturally available sandstone units can be used. Usually, it is relatively light and easy to shape by hand using a steel edge. The compressive strength of such units should be at least 7-10 MPa. The size of such hand-shaped units shall not exceed 300 mm × 150 mm × 100 mm.



### **Cement Blocks**

Machine-made cement blocks with 12.5 mm and down aggregated (in 1:3:6 mix of cement, sand and aggregate) can be used. These units should be properly cured to result in a compressive strength of such units of at least 7-10 MPa. The size of such hand-shaped units shall be similar to that of the burnt clay bricks, namely 230 mm × 115 mm × 75 mm.

## Should masonry units be watered before I use ?

Natural stone with no or little porosity (like granite) need not be soaked before use, but should be cleaned. But, the burnt clay bricks, fly ash bricks, cement blocks and sandstone blocks are porous, and hence should be watered for about 4 hours before laying. This can be done by

- (a) Submerging them in a tub, or
- (b) Watering them regularly with a hose to keep them wet all through.

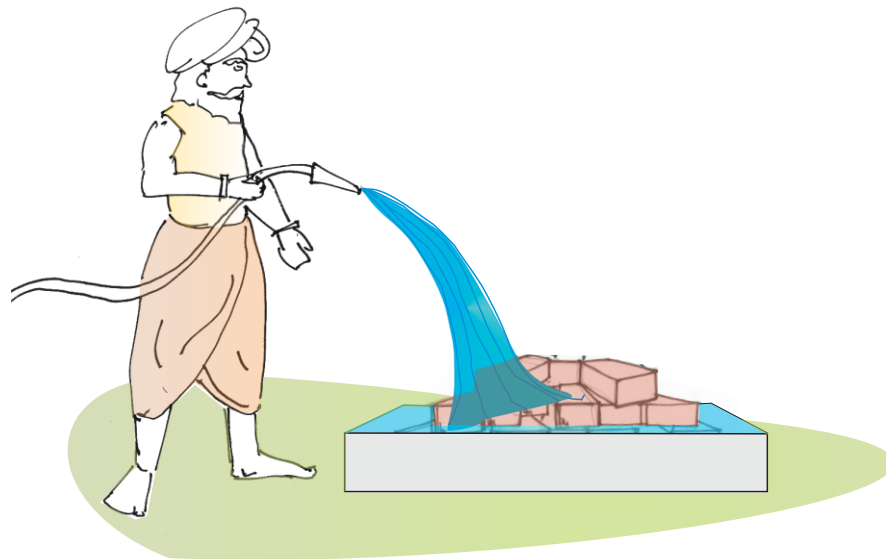

## What materials are required to build my roof ?

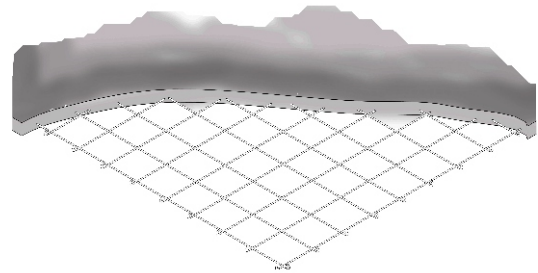
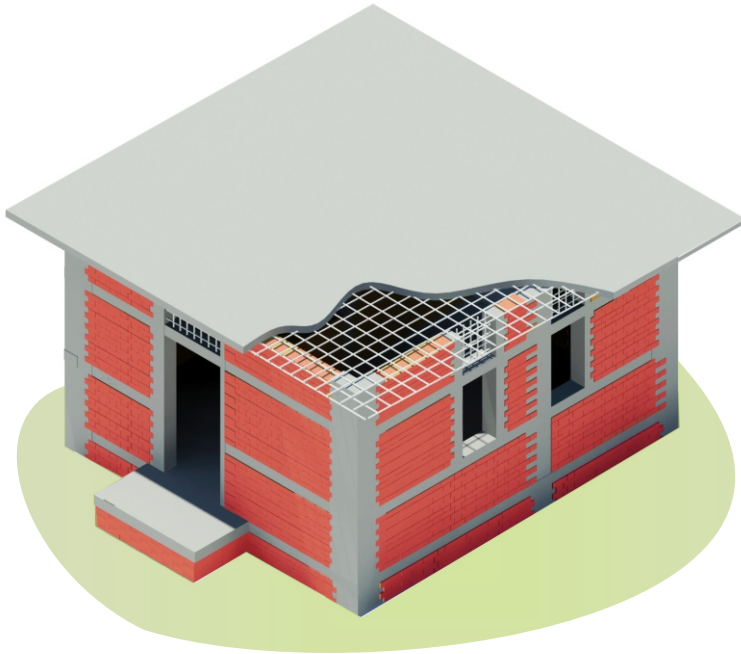

**Flat Roof**  
Reinforced Concrete



**Sloping Roof**  
Metal Sheet roofing  
supported on steel angles

# What materials are required to build my floor ?

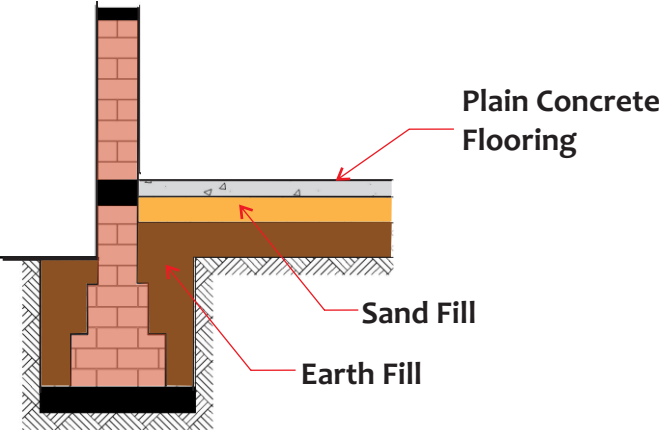
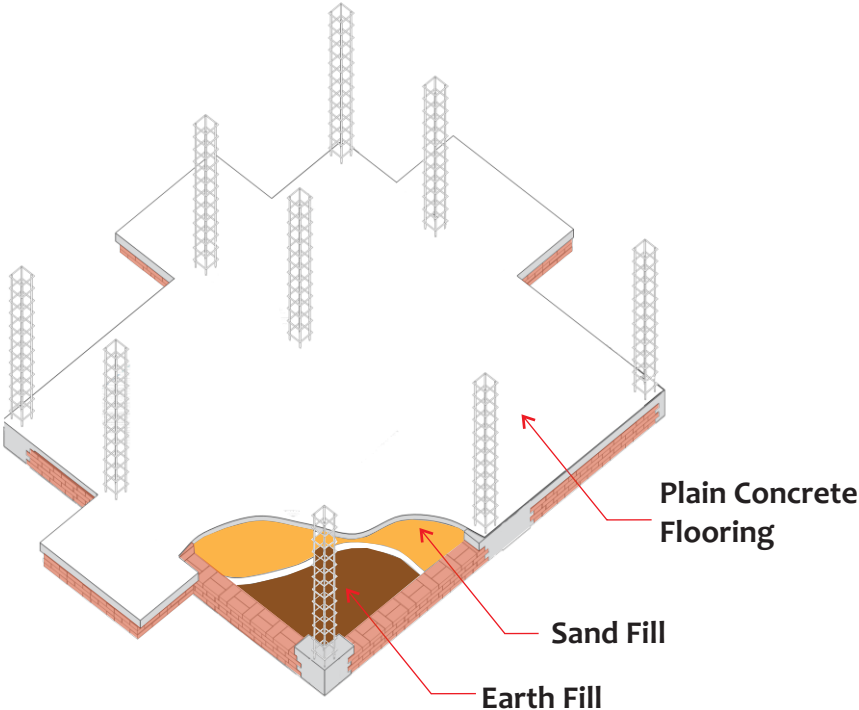

## How do I measure materials for construction?

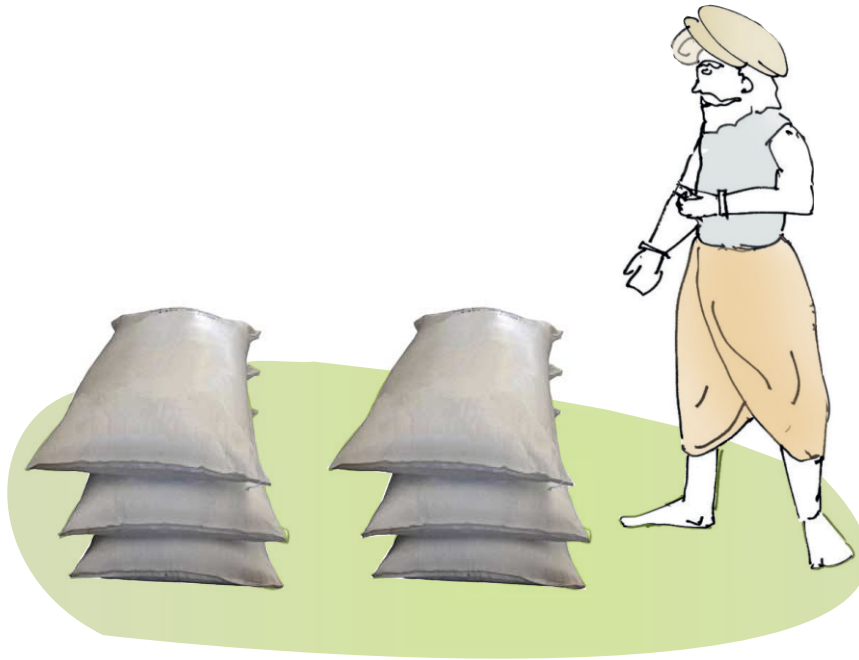

Each cement bag has 50 kg of cement

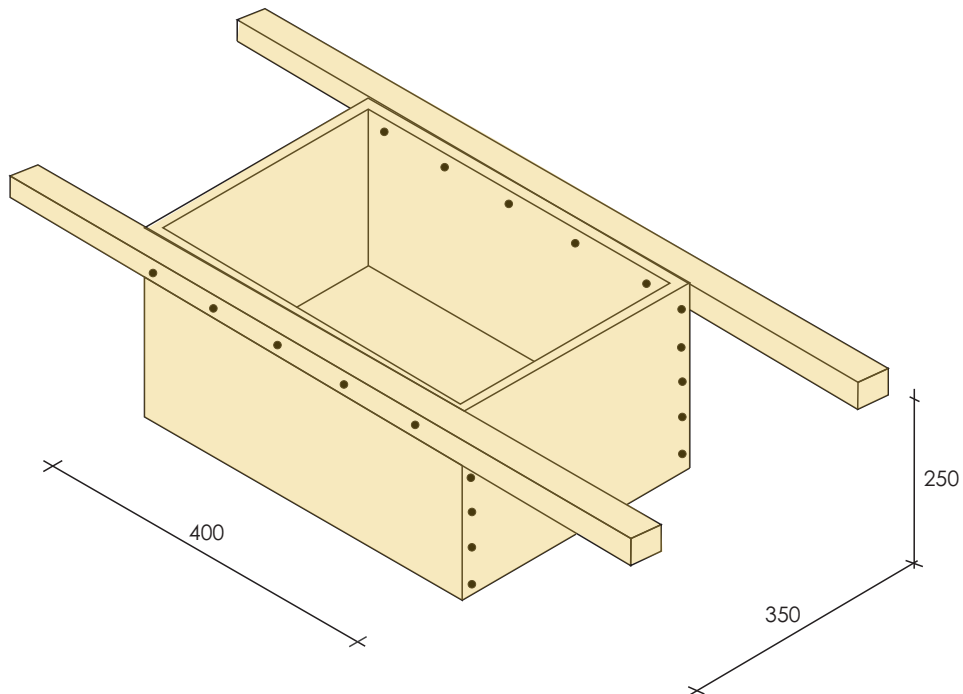

Inner dimensions of the box made of local wood for measuring sand and aggregates

# What proportions of materials do I need?



**Cement**  
1 Box

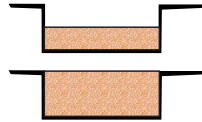

**Clean Sand**  
1 1/2 Boxes



**Aggregate**  
3 Boxes

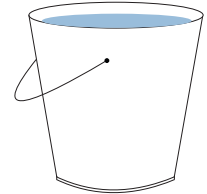

**Water**  
22 Litres

Concrete for roof slab



**Cement**  
1 Box

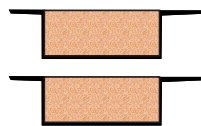

**Clean Sand**  
2 Boxes

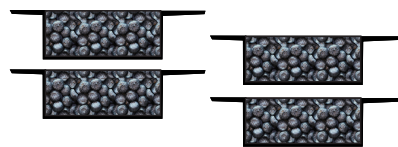

**Aggregate**  
4 Boxes

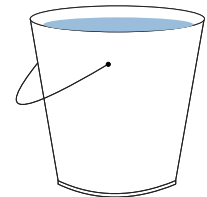

**Water**  
22 Litres

Concrete for RC vertical element and bands



**Cement**  
1 Box

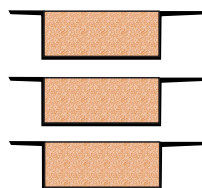

**Clean Sand**  
3 Boxes

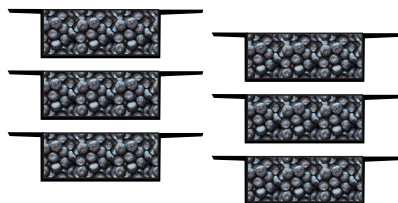

**Aggregate**  
6 Boxes

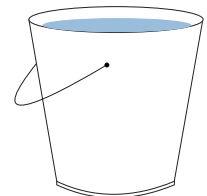

**Water**  
22 Litres

Concrete for foundation mat and flooring

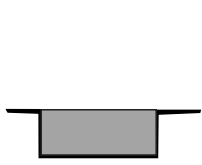

**Cement**  
1 Box

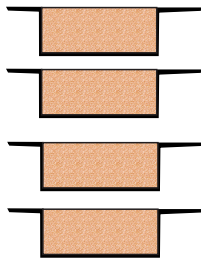

**Clean Sand**  
4 Boxes

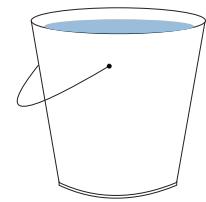

**Water**  
20 Litres

Mortar for masonry

## How do I make confined masonry walls ?

Course 1, 3, 5, ...

Course 2, 4, 6, ...

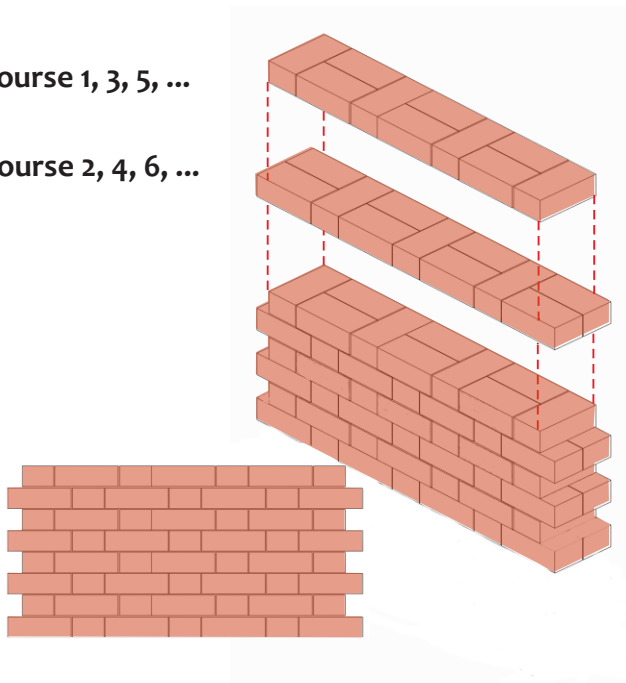

Build walls in Flemish Bond

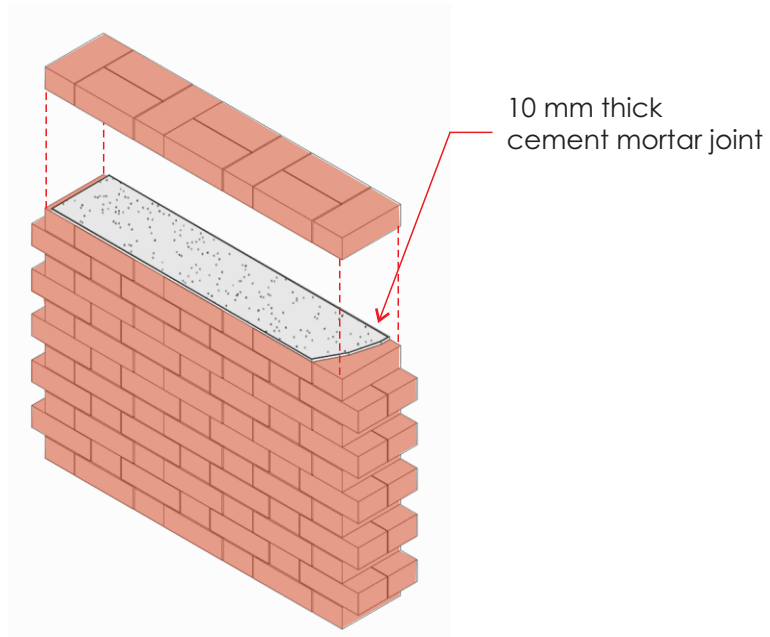
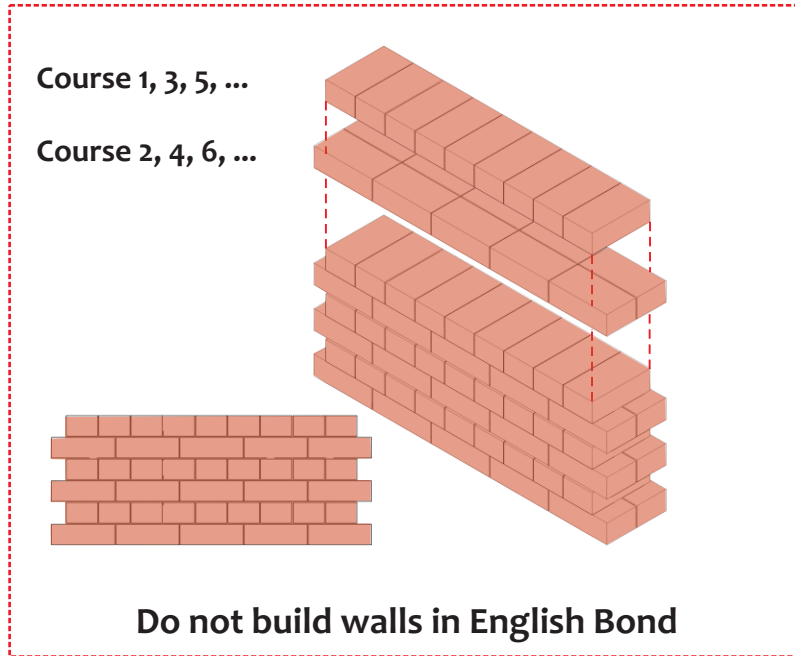

Provide 10mm thick cement mortar joints between brick courses

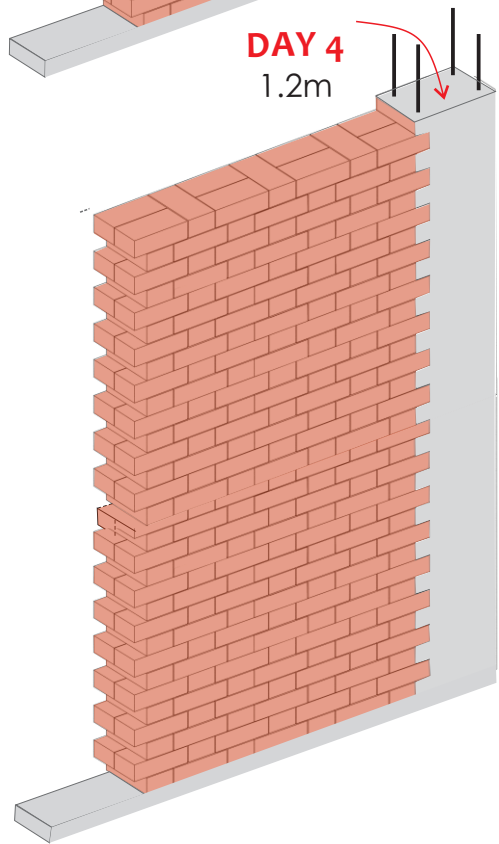
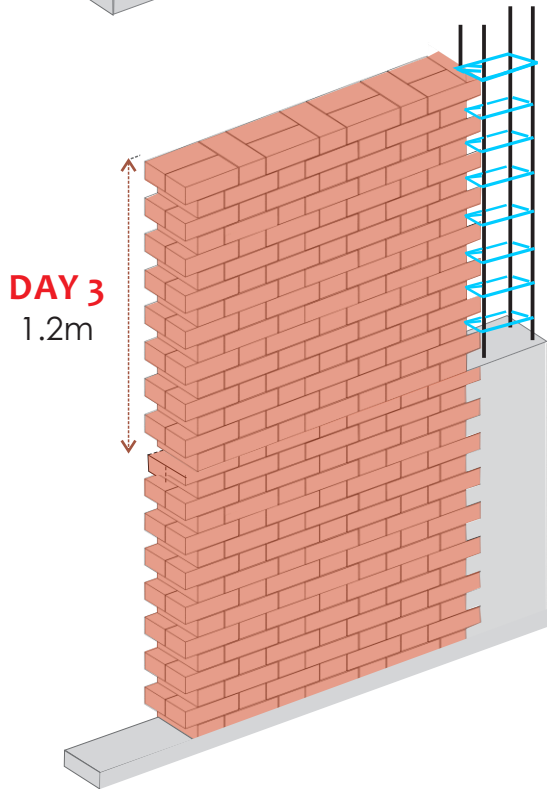
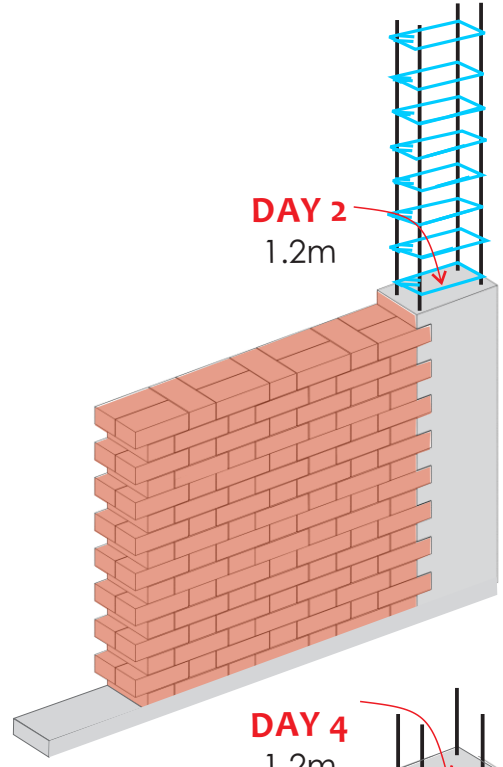
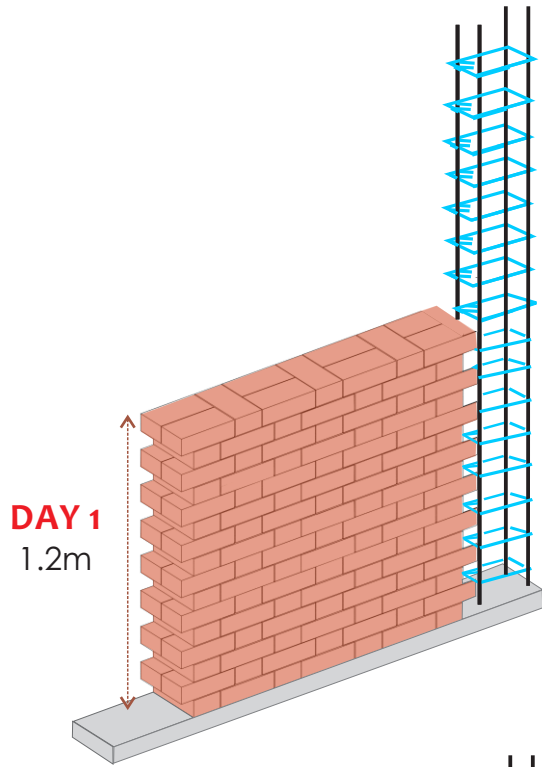

Build a maximum of 1.2 m of masonry wall segments in a day

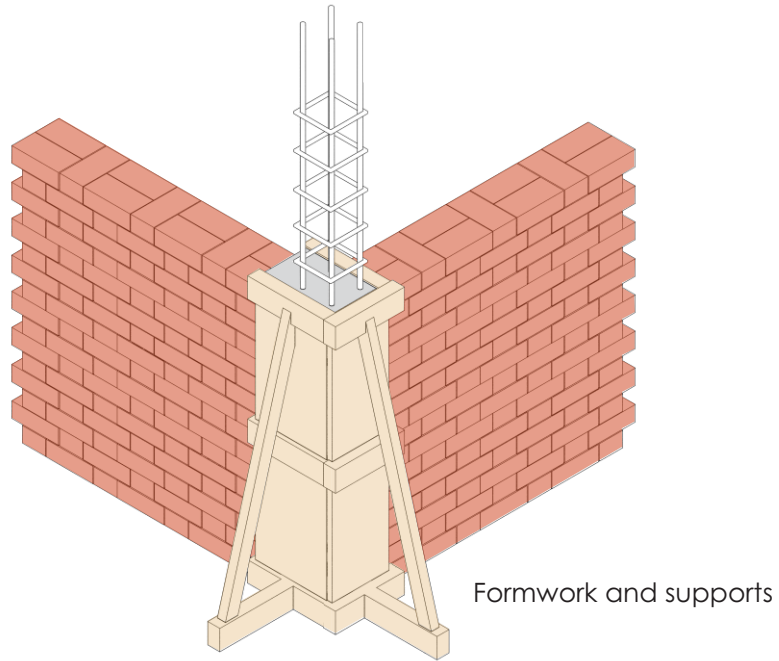

Provide vertical formwork with supports for pouring concrete of RC vertical elements at brick masonry wall junctions

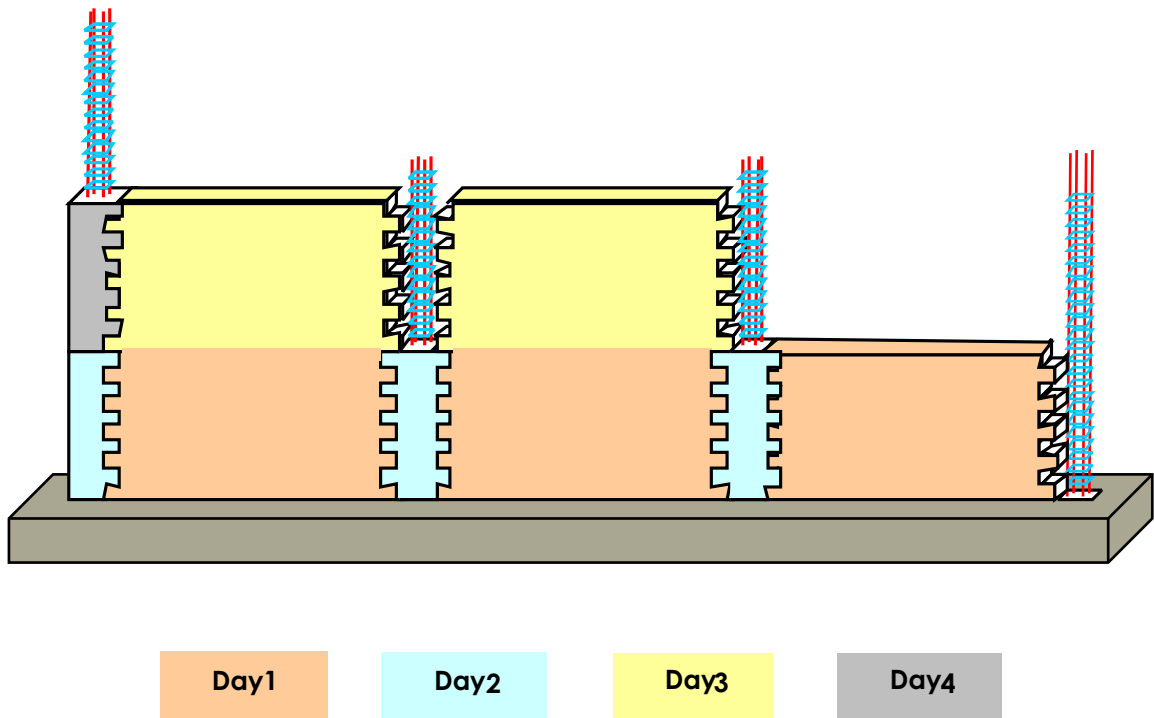

Build the walls leaving slots for RC elements

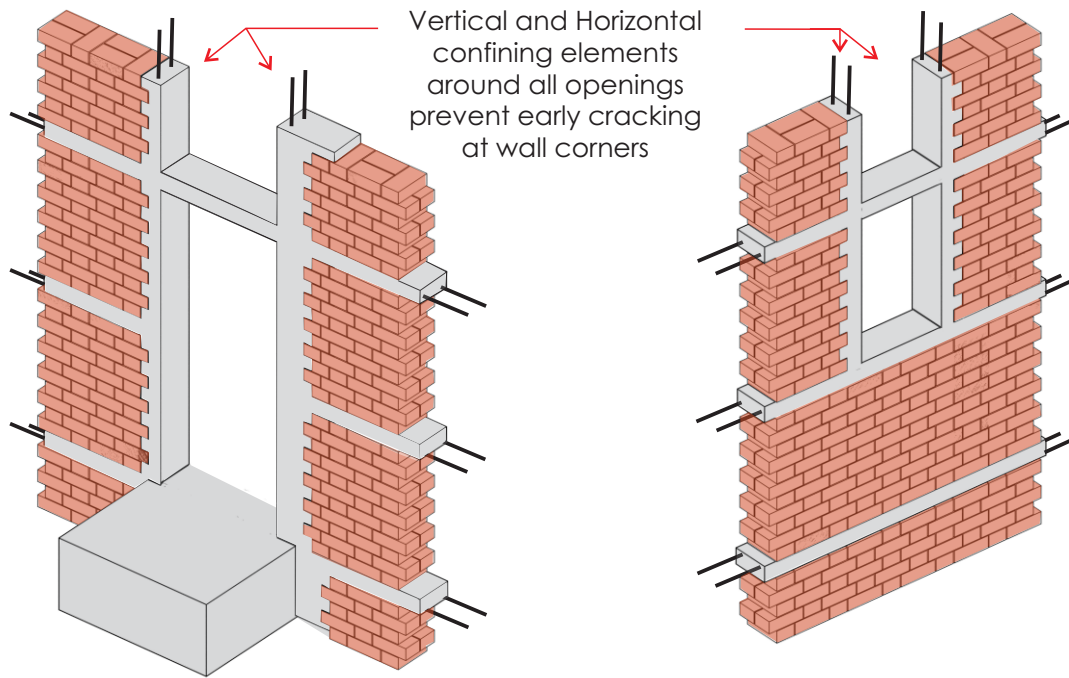

Lintel, Sill and Plinth bands pass through the vertical RC elements  
 RC bands and elements support the brick masonry at openings

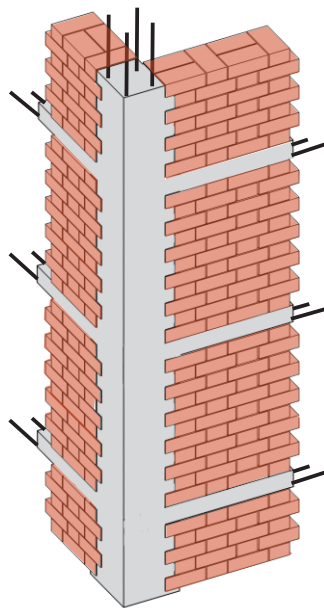

Vertical RC elements keep brick masonry segments in place at the corners

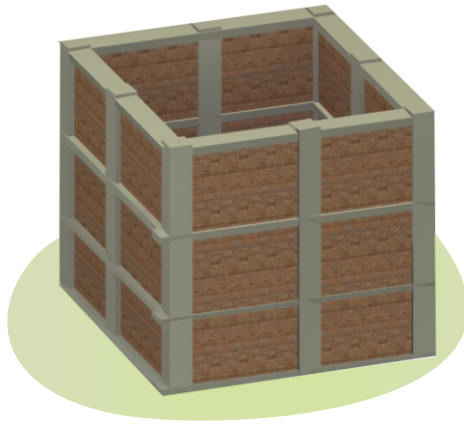

Masonry wall segments  
confined on all sides with RC elements

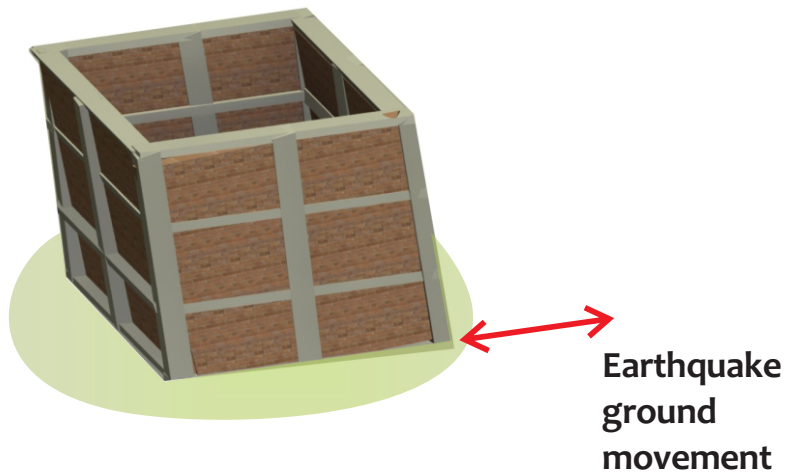

RC elements  
prevent masonry from collapsing

Vertical RC elements and horizontal RC bands hold masonry wall segments together (like a strap holding a package)

# How do I make horizontal RC bands ?

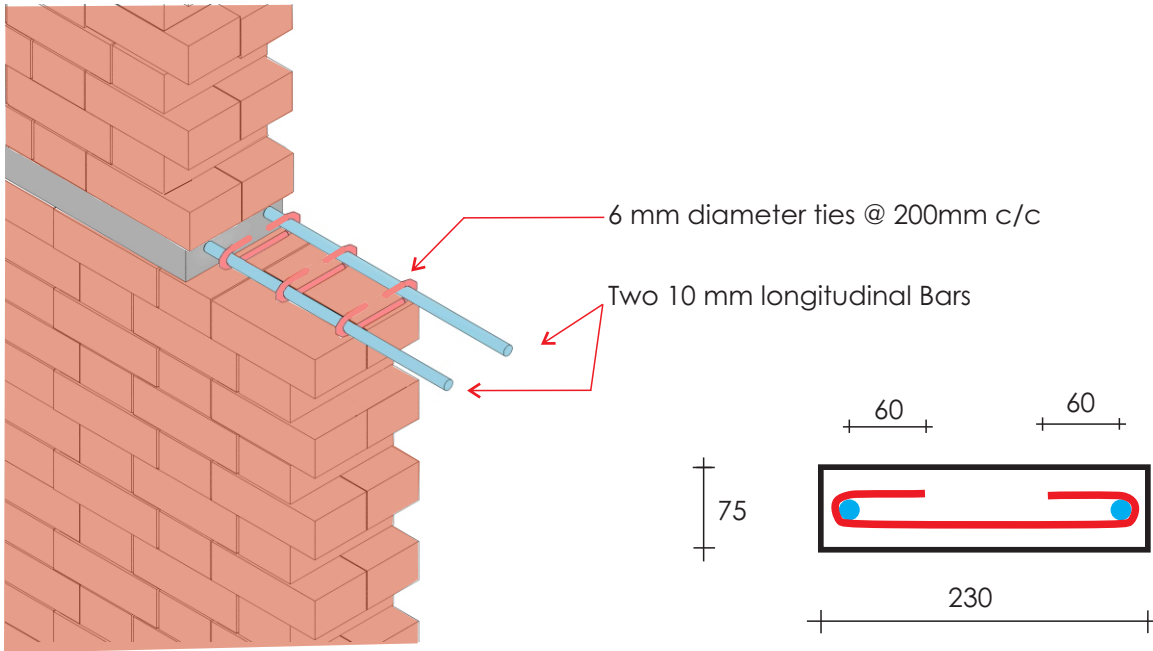

**Sill and Lintel Bands**

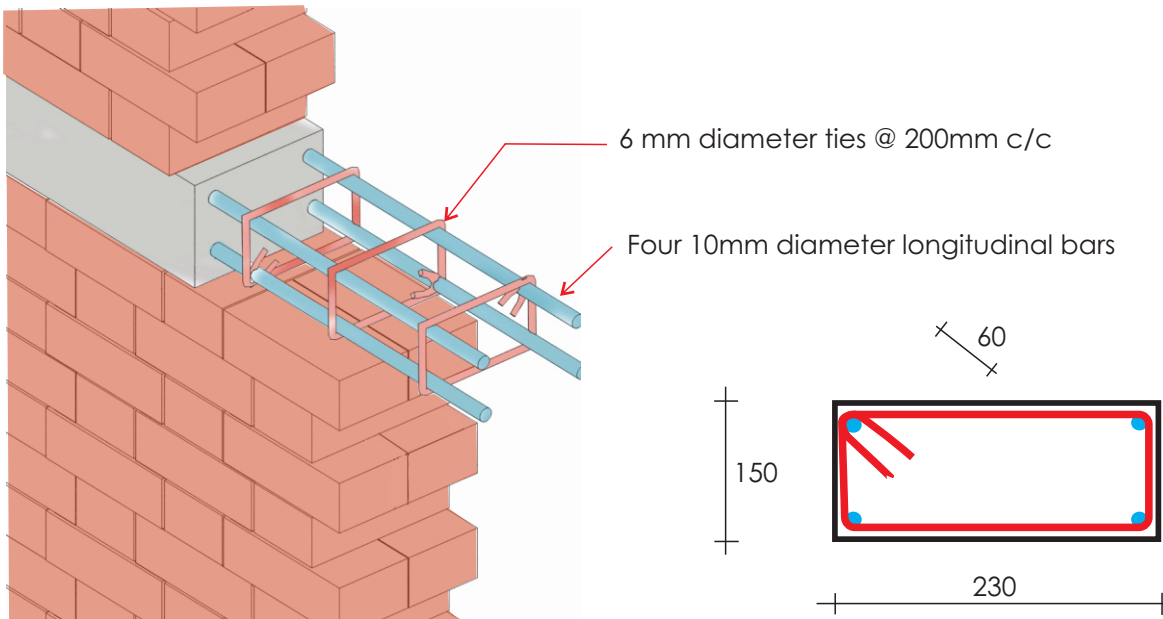

**Plinth Band**

# How do I make vertical RC elements ?

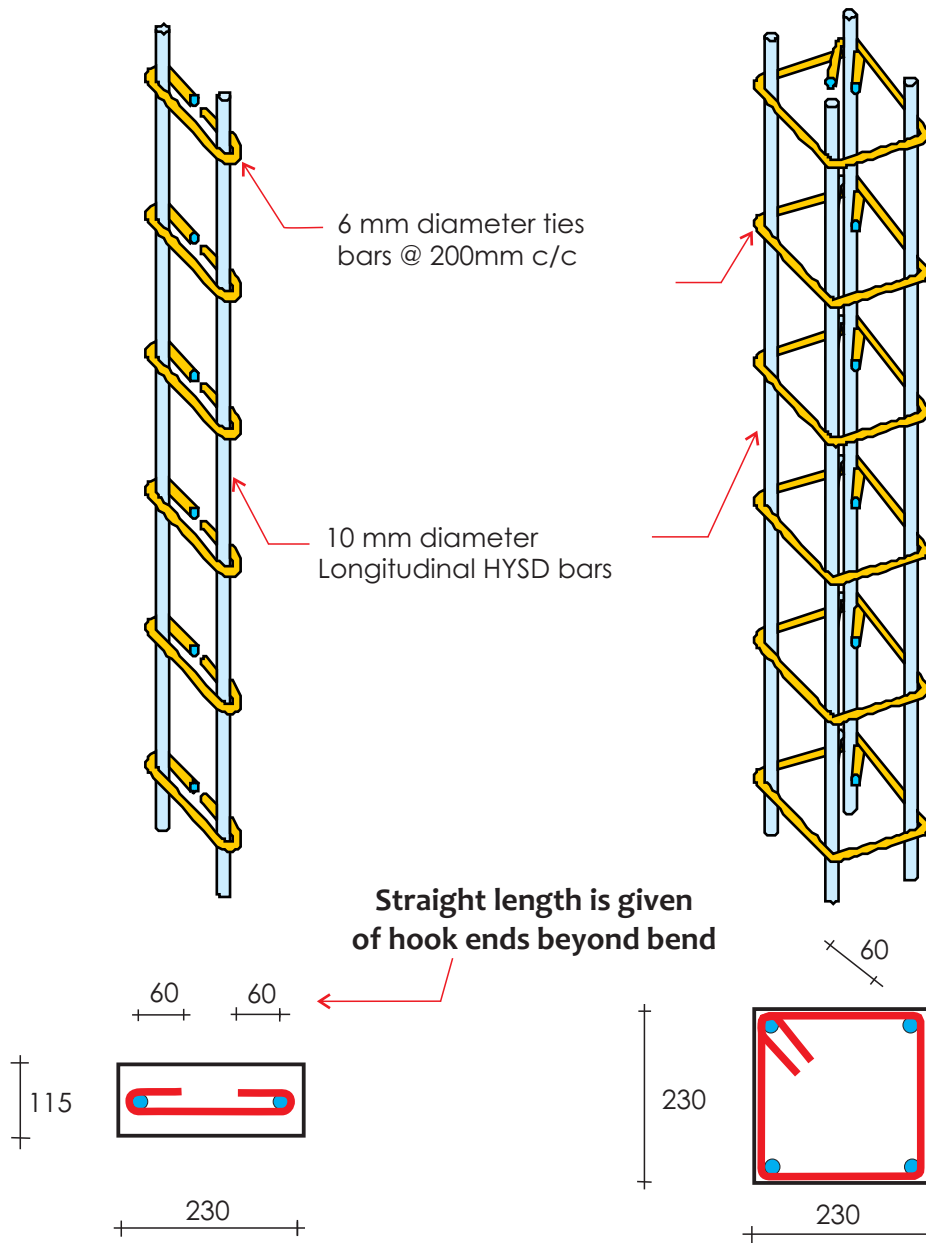

**Reinforcement in Vertical RC confining members around door openings (230mm X 115mm)**

## How do I pass longitudinal bars of horizontal RC bands through vertical RC elements ?

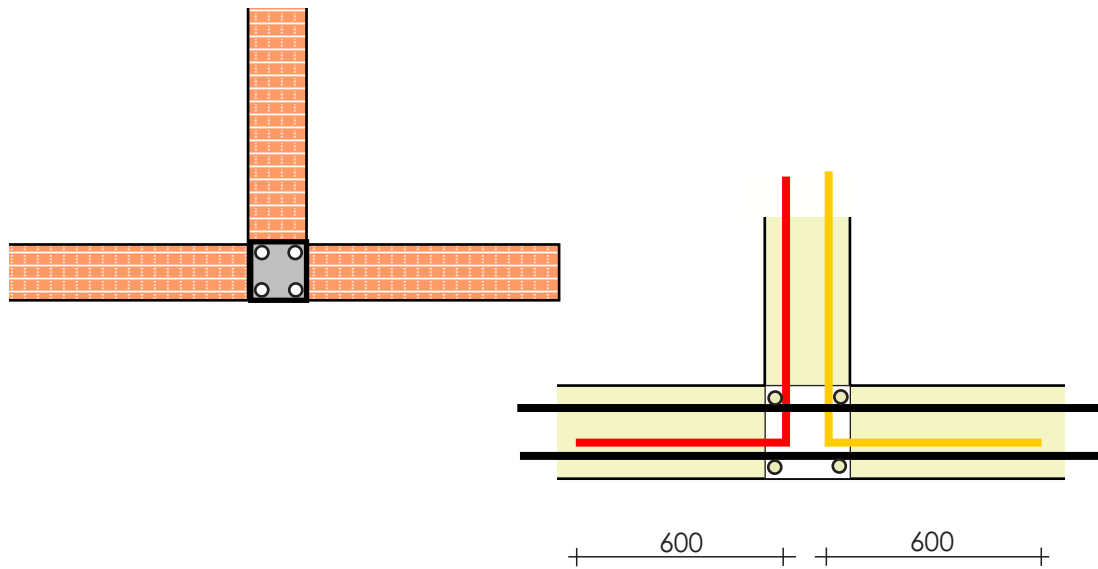

### T-Junction of Walls

Reinforcement bars will be at two levels, one above the other

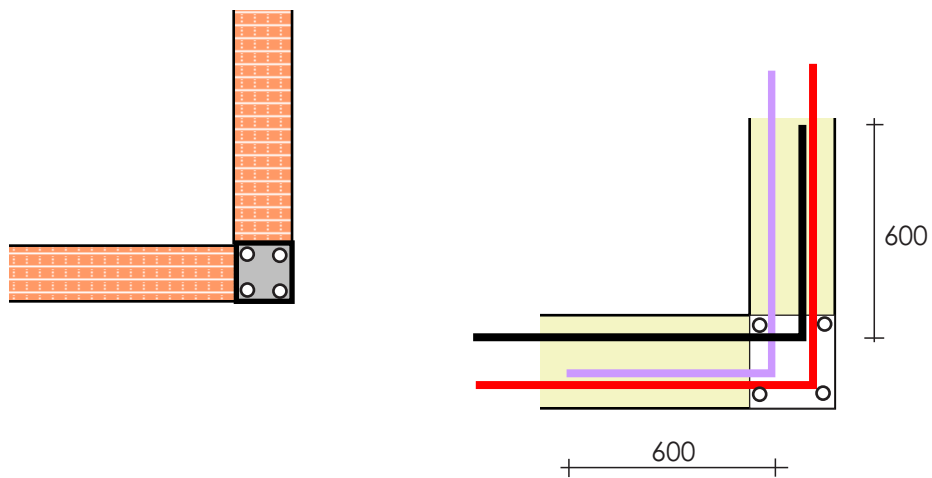

### L-Junction of Walls

Reinforcement will be at two levels, one above the other

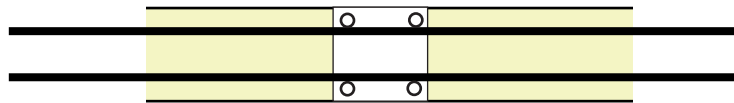
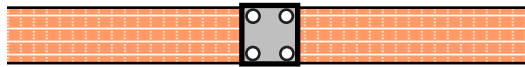

### Straight Walls

Reinforcement bars will be at one level

## Reinforcement detail at junction of RC element and RC sill band

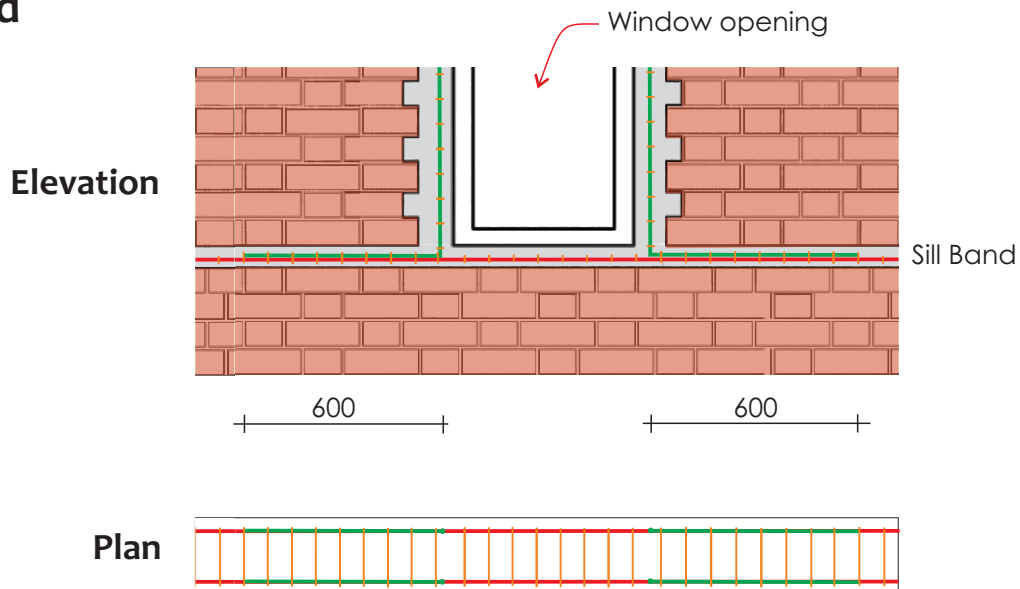



**Construction of  
Confined Masonry House  
- Option 1**



# How do I build my Confined Masonry House ?

## Step-wise Procedure

Construction of a Confined Masonry House entails 3 major phases, namely

**Foundation and Plinth**



**Superstructure**



**Roof**



In this section, sequence of construction is elaborated pictorially in a step-wise procedure to recall all salient steps in the making of a Confined Masonry House. The following colour code is adopted for the above three phases of construction:

## Foundation and Plinth

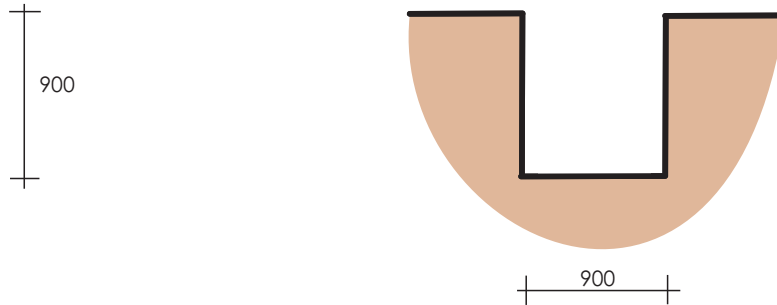

### Step 1

Dig a pit 900 mm wide and 900mm deep along the wall line of the house.

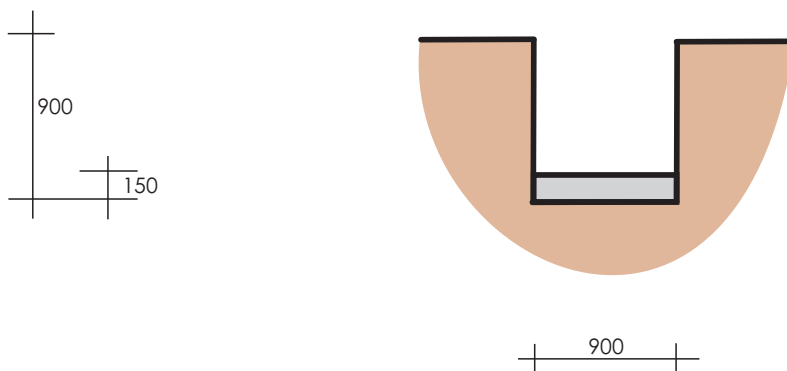

### Step 2

Pour in this pit plain cement concrete (1:3:6 mix of cement, sand and aggregate) of 150 mm thickness

## Foundation and Plinth

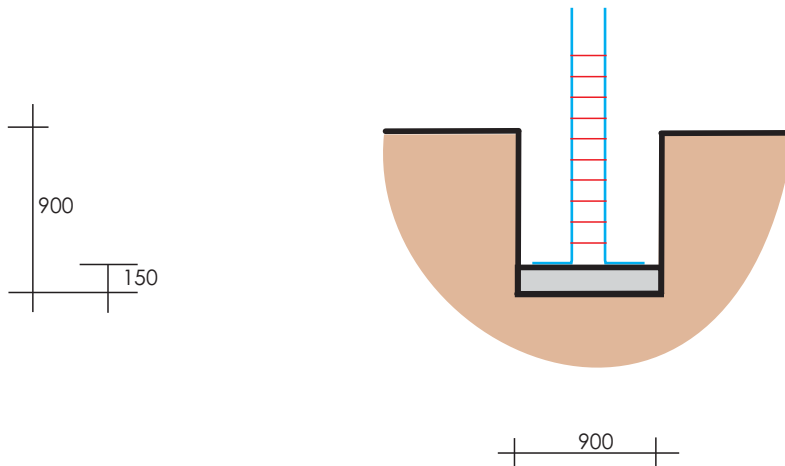
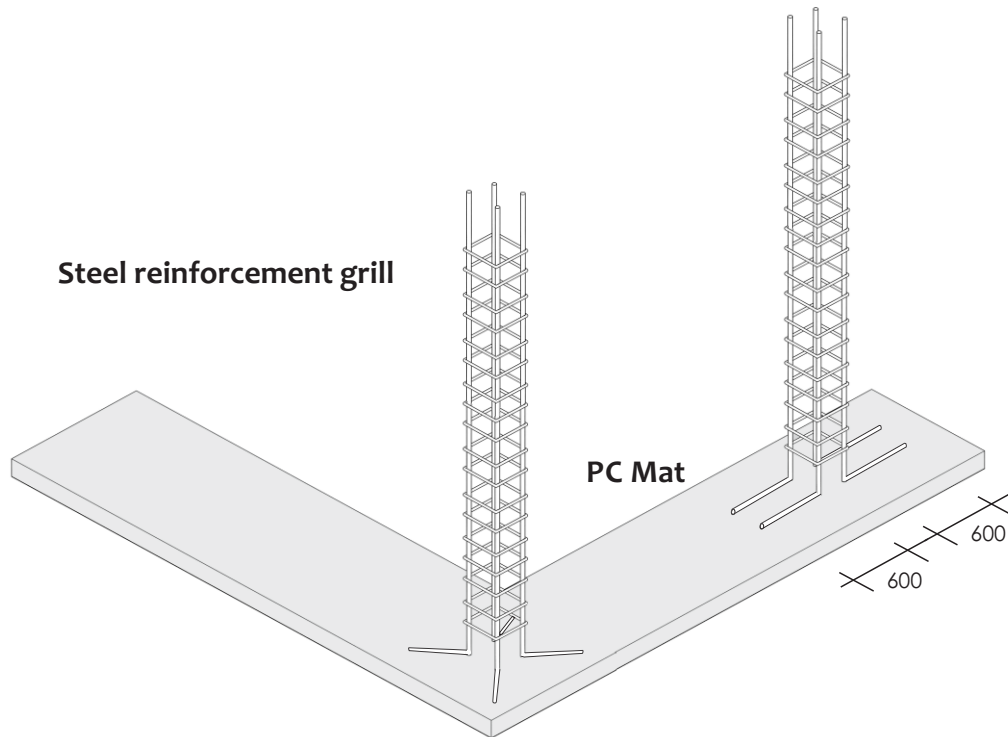

### Step 3

Prepare reinforcement grill of RC vertical elements. Use steel reinforcement bars of full height till the roof level, up to which RC vertical elements are required. Provide lateral supports to hold these reinforcement grills during construction.

## Foundation and Plinth

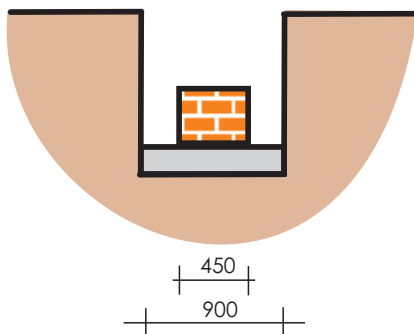
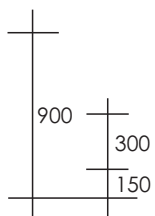
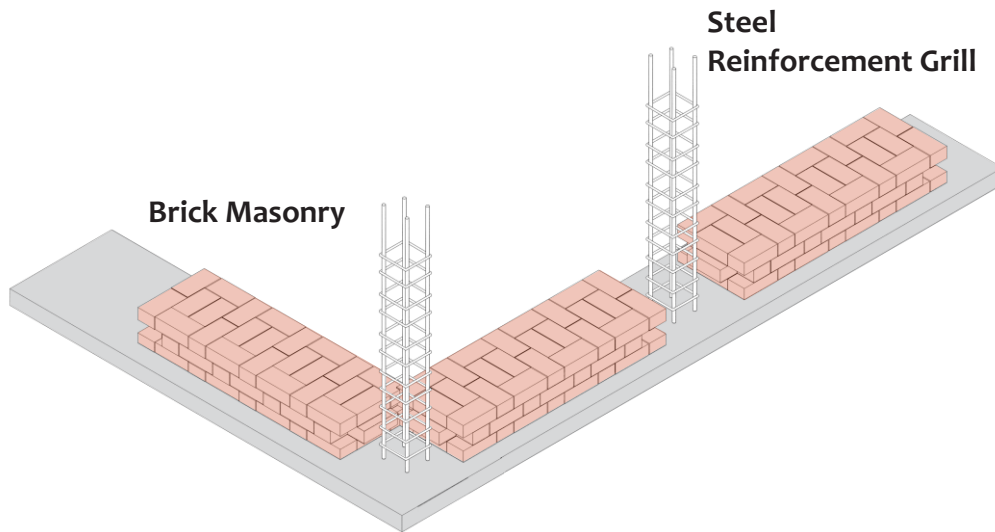

**Brick Masonry**

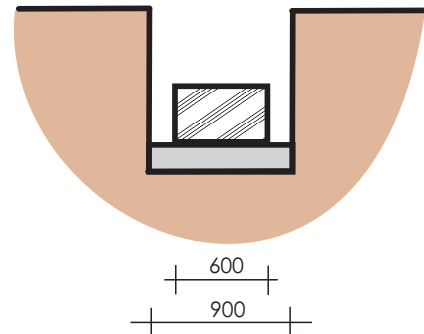

**Stone Masonry**

### Step 4

Lay the first three masonry courses with cement mortar (1:4 mix of cement and sand) over the plain concrete mat leaving gaps near steel reinforcement provided for RC vertical elements.

# Foundation and Plinth

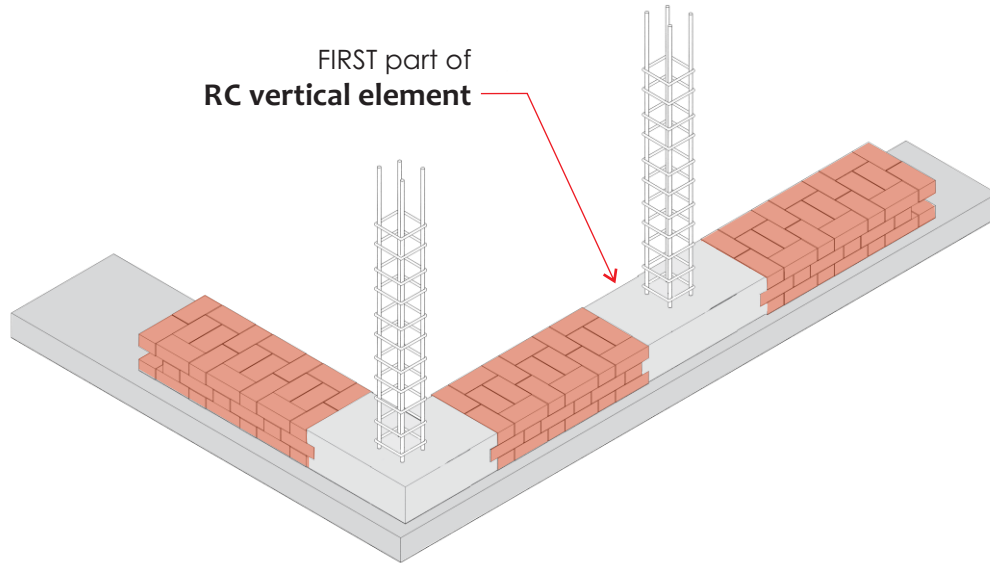

## Step 5

Pour concrete (1:2:4 mix of cement, sand and aggregate) in gaps between brick masonry and steel reinforcement bars.

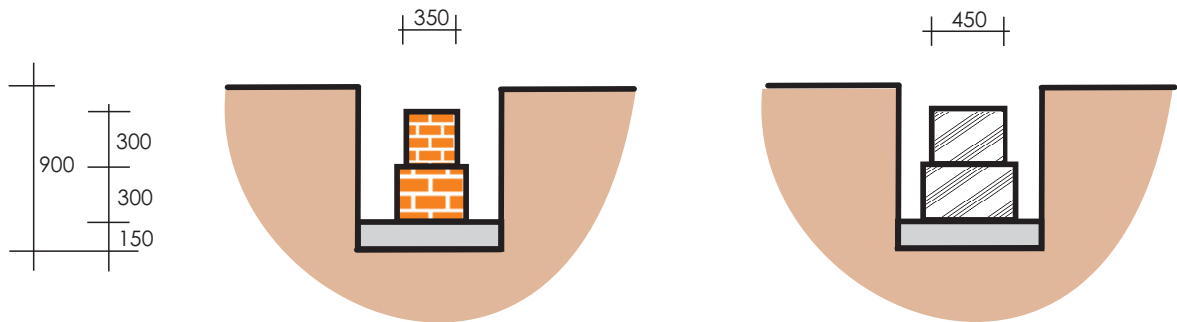

Brick Masonry

Stone Masonry

## Step 6

Place the next four masonry courses with cement mortar (1:4 mix of cement and sand) above the earlier brick masonry wall

## Foundation and Plinth

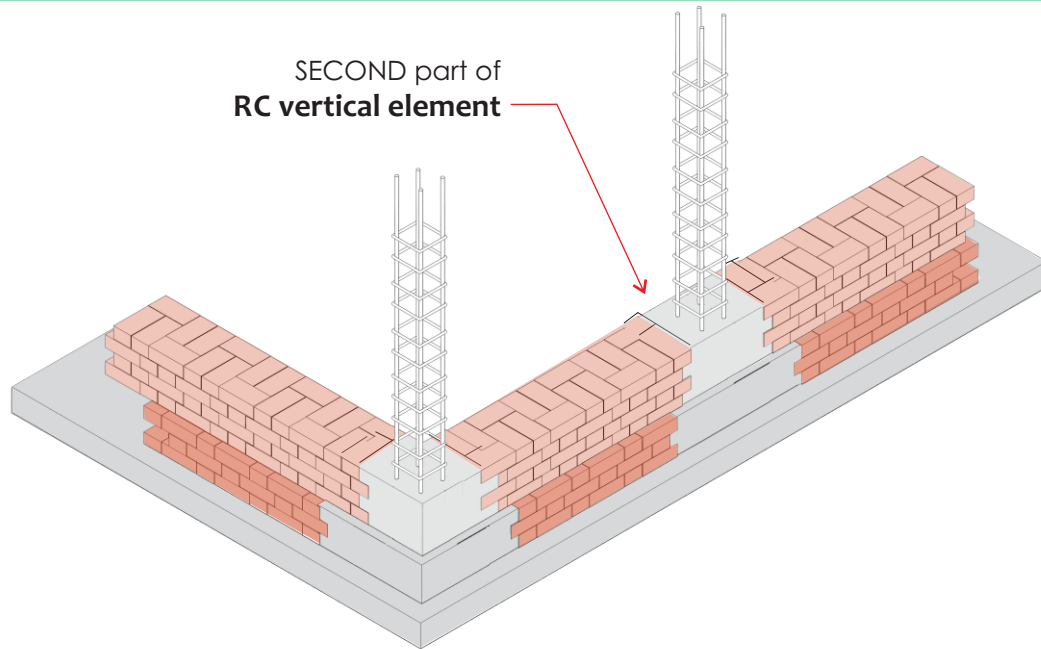

### Step 7

Pour concrete (1:2:4 mix of cement, sand and aggregate) around steel reinforcement grill up to the top level of masonry course made so far.

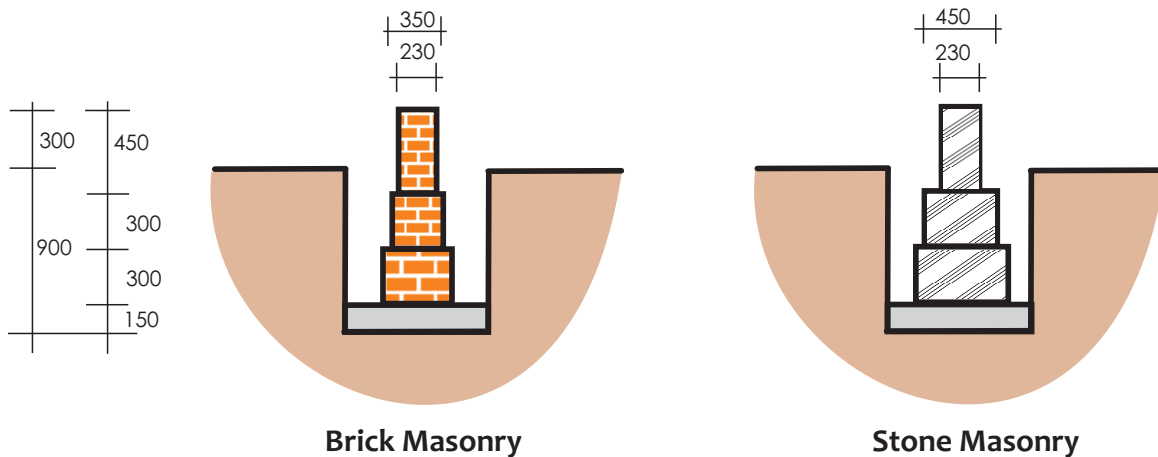

### Step 8

Place the next four masonry courses with cement mortar (1:4 mix of cement and sand)

## Foundation and Plinth

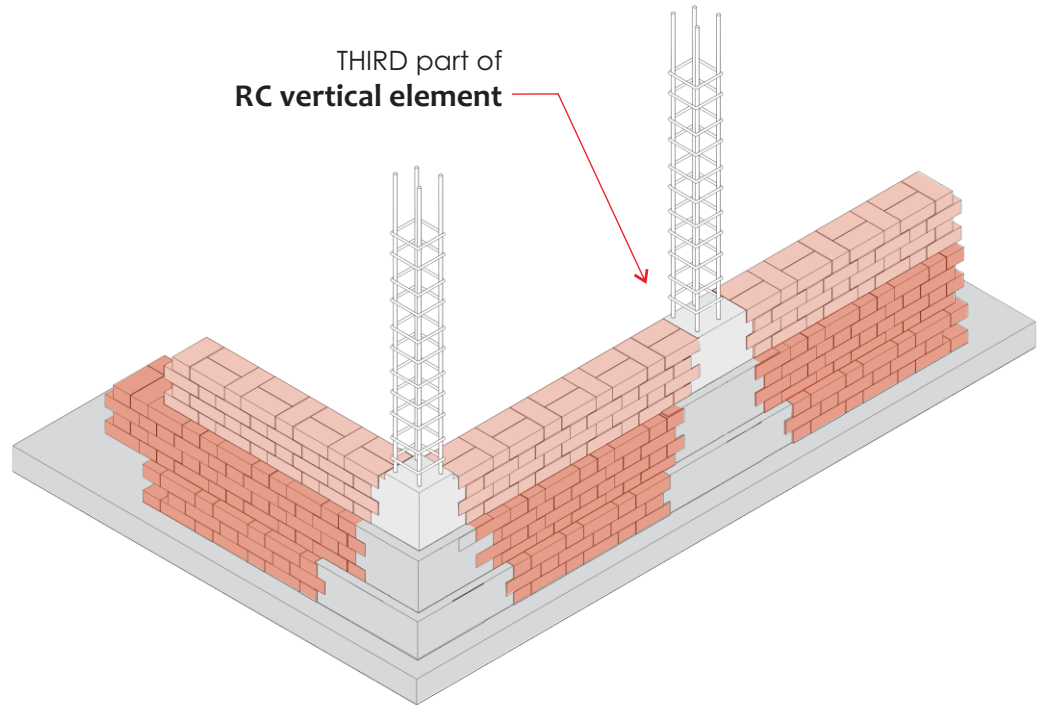

### Step 9

Pour concrete (1:2:4 mix of cement, sand and aggregate) around steel reinforcement grill up to the top level of masonry course made so far.

## Foundation and Plinth

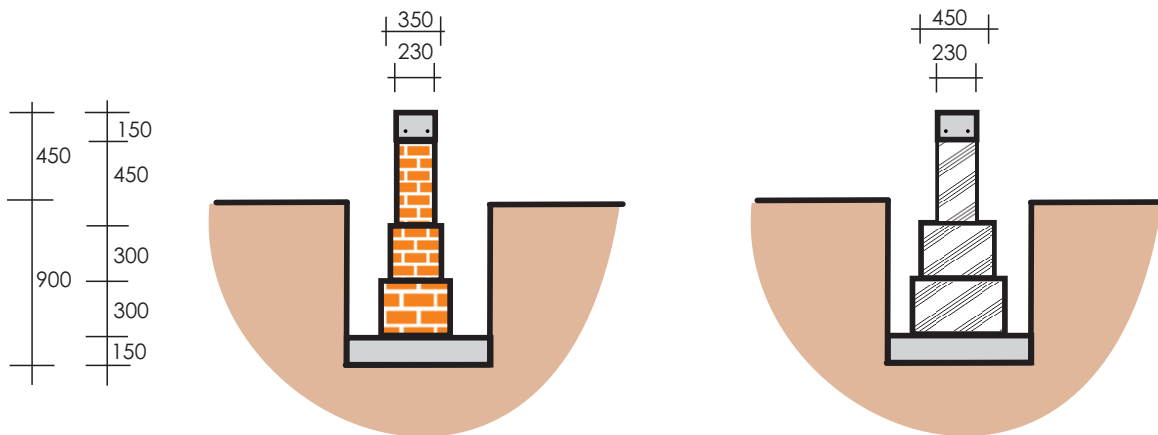
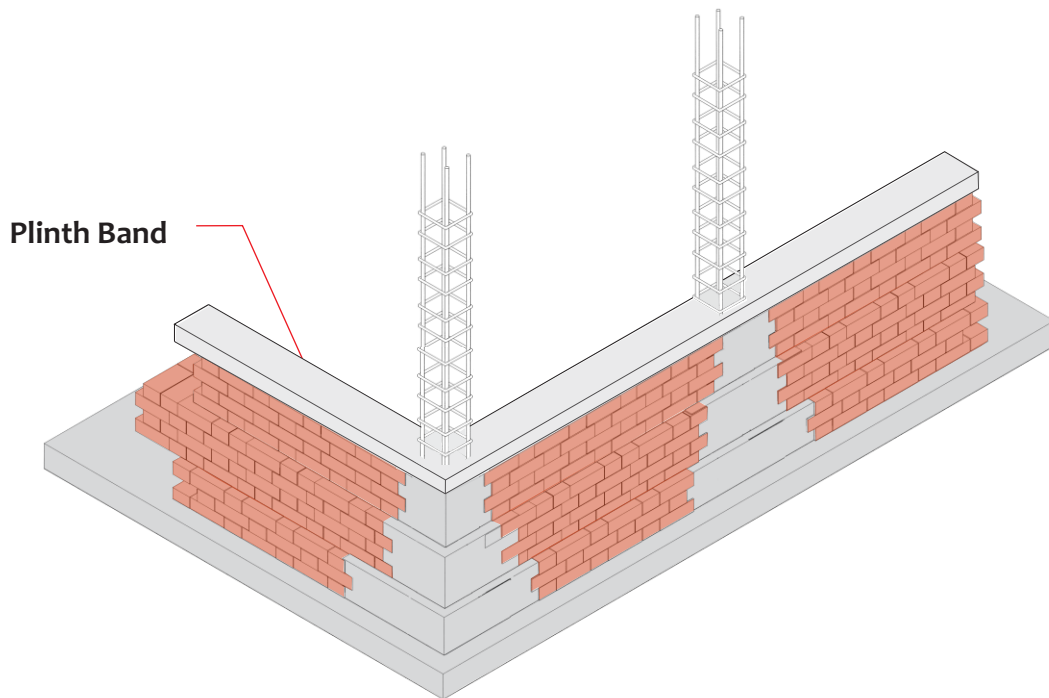

**Brick Masonry**

**Stone Masonry**

### Step 10

Place steel reinforcement grill for the plinth beam, and pour concrete (1:2:4 mix of cement, sand and aggregates) for plinth band above brick masonry

# Foundation and Plinth

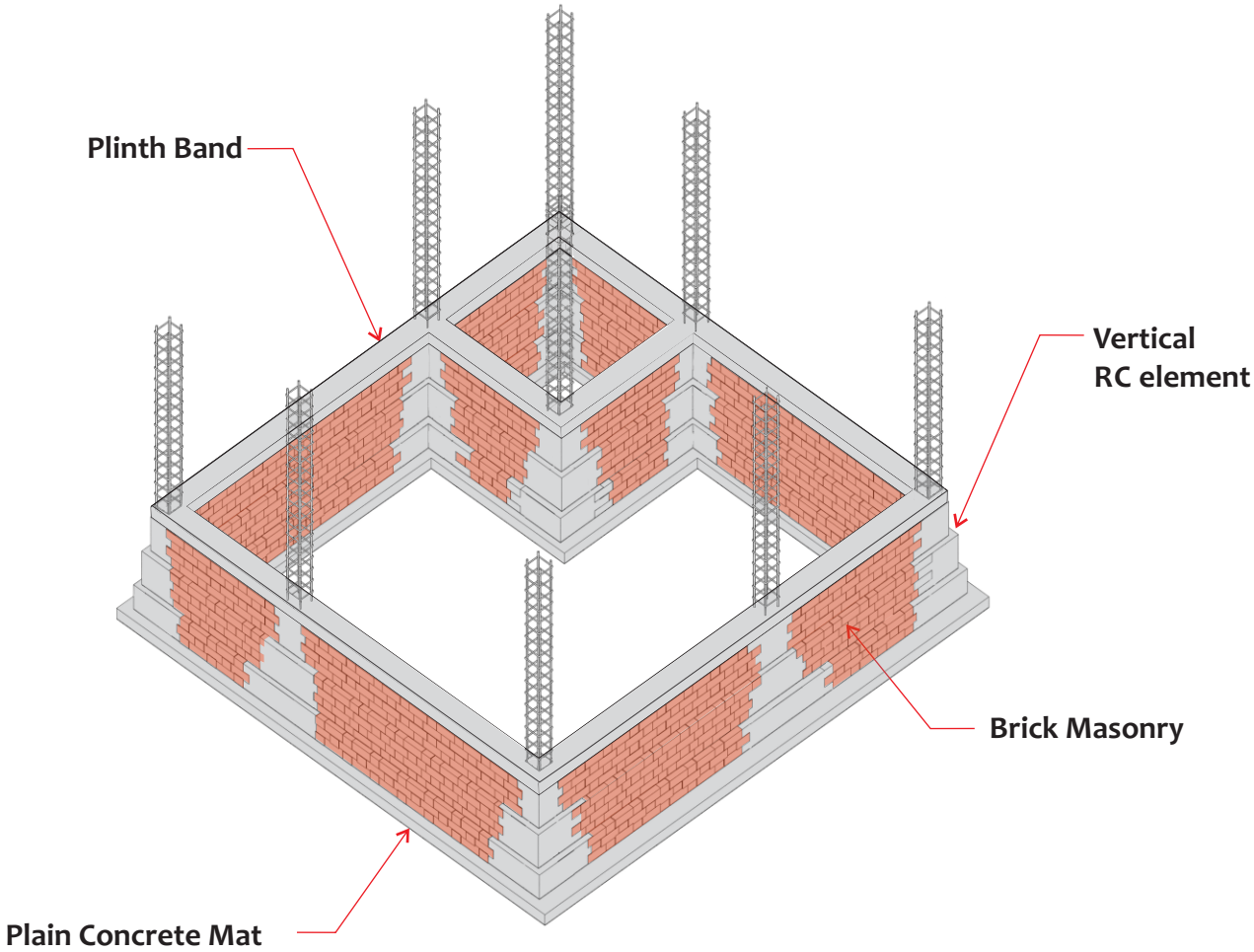

**View of my Confined Masonry House**  
*after Step 10*

## Foundation and Plinth

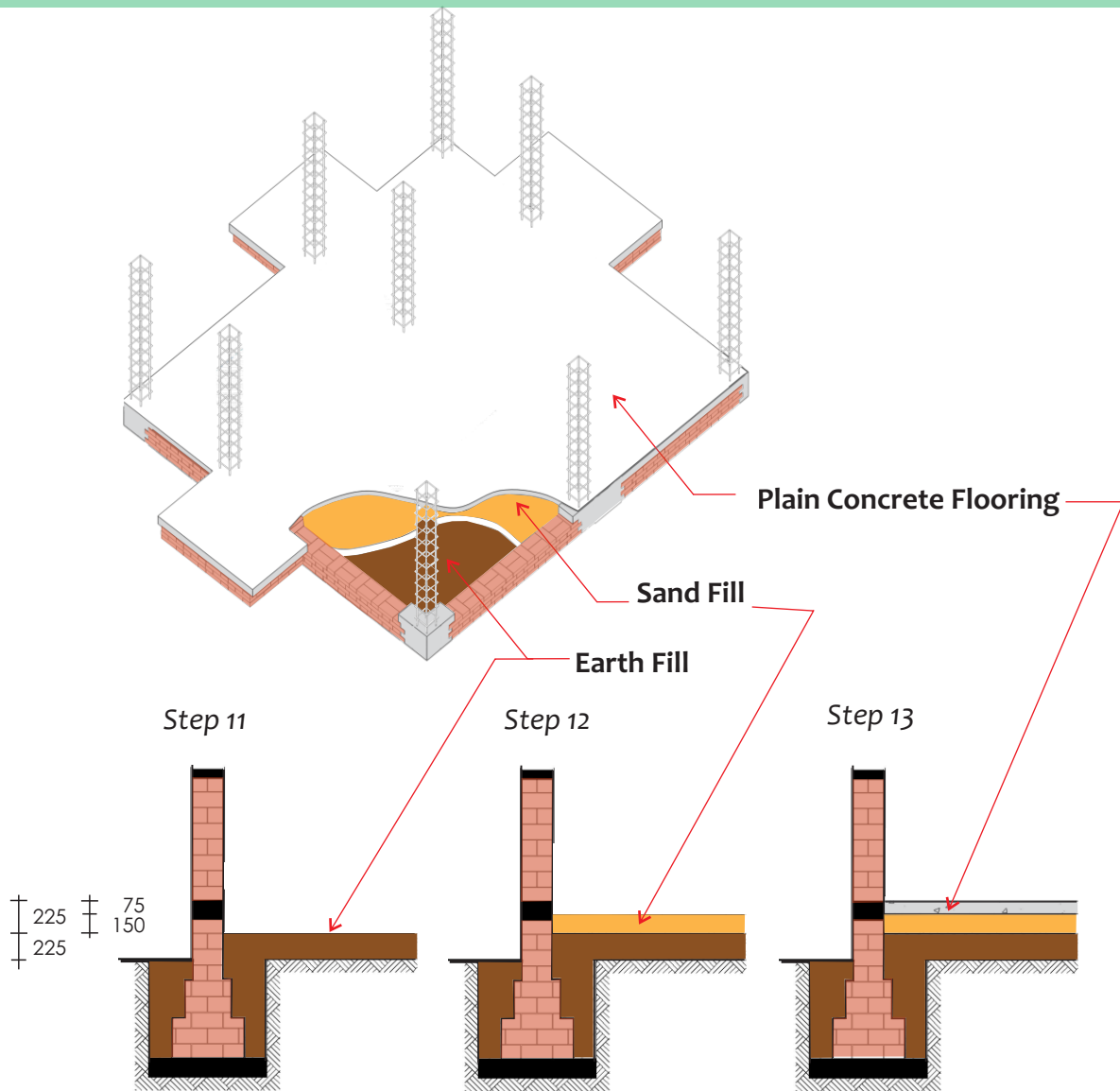

### Step 11

Fill the plinth with earth up to 225 mm above native ground level.

### Step 12

Top the earth fill with 150mm thick sand bed.

### Step 13

Place the plain concrete (1:3:6 mix of cement, sand and aggregate) over the layer of sand.

## Foundation and Plinth

For the construction of Foundation and Plinth, the materials required are:



### Cement

36 bags



### Sand

6.8 m<sup>3</sup>



### Aggregates

20 mm (Nominal) : 3.1 m<sup>3</sup>

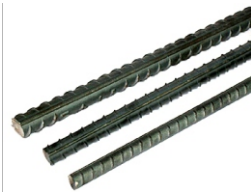

### Steel

High Strength Steel : 180 m of **10** mm diameter bars  
Mild Steel : 190 m of **6** mm diameter bars

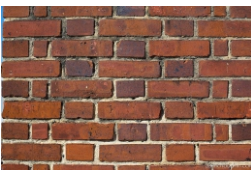

### Burnt Clay Bricks

3,600

# Walls

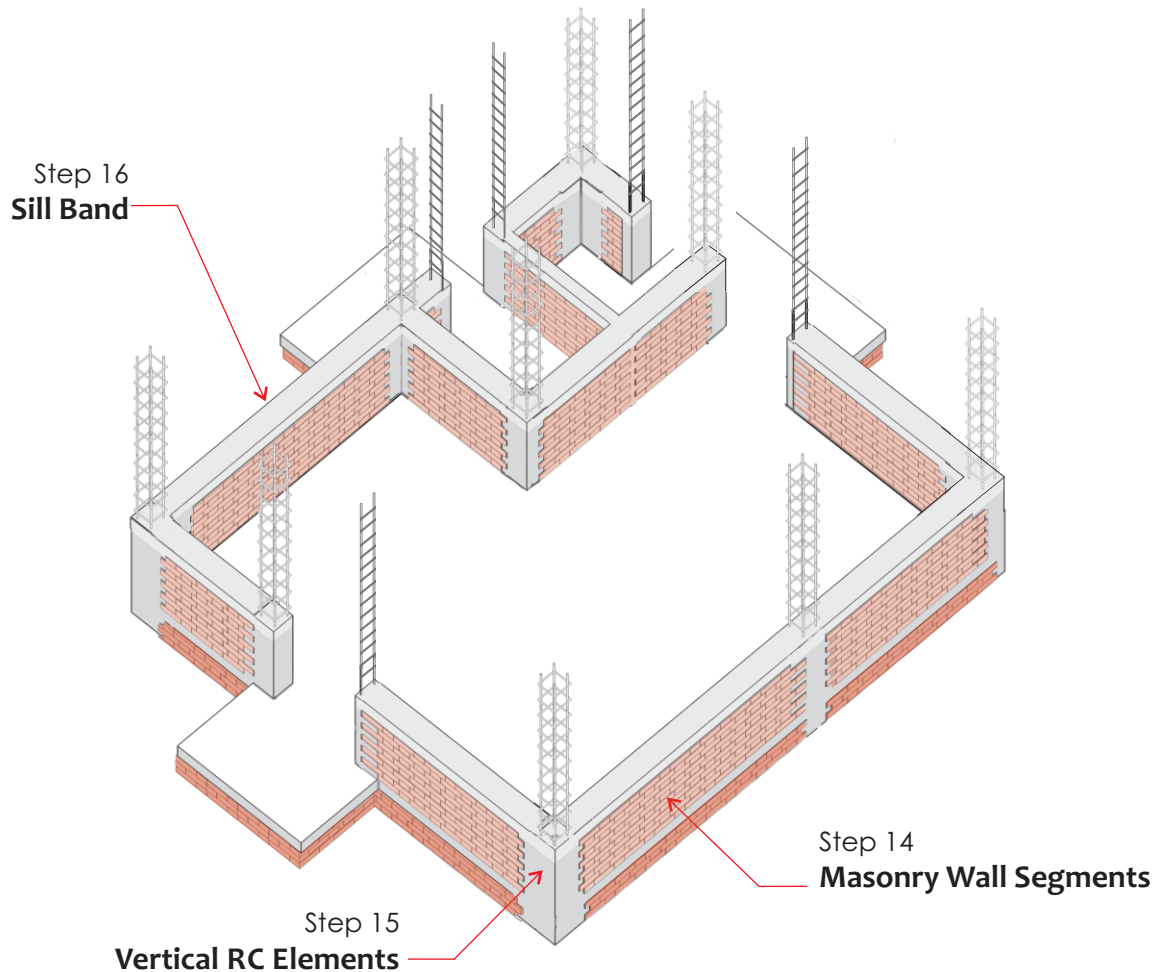

## Step 14

Build masonry wall segments till 75 mm below sill level.

## Step 15

Pour concrete (1:2:4 mix of cement, sand and aggregate) of vertical RC elements around steel reinforcement grill up to the level of top masonry course.

## Step 16

Place the steel reinforcement cage and pour concrete (1:2:4 mix of cement, sand and aggregate) for Sill Band.

## Walls

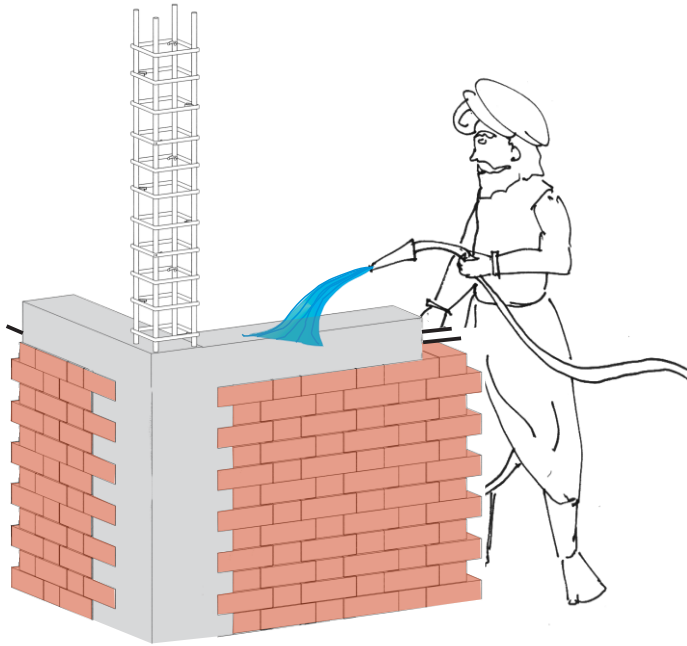

Direct wetting with water hose

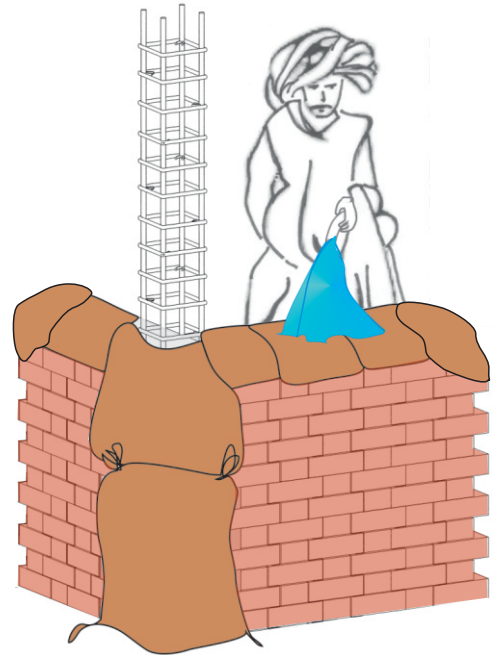

Keeping the jute sheets moist

### Step 17

Cure the vertical RC elements and horizontal RC bands for at least 7 days. Two options are available, namely (a) wetting the RC elements with direct water jet every hour, and (b) cover the RC elements with jute sheets and keeping the jute sheets moist throughout.

# Walls

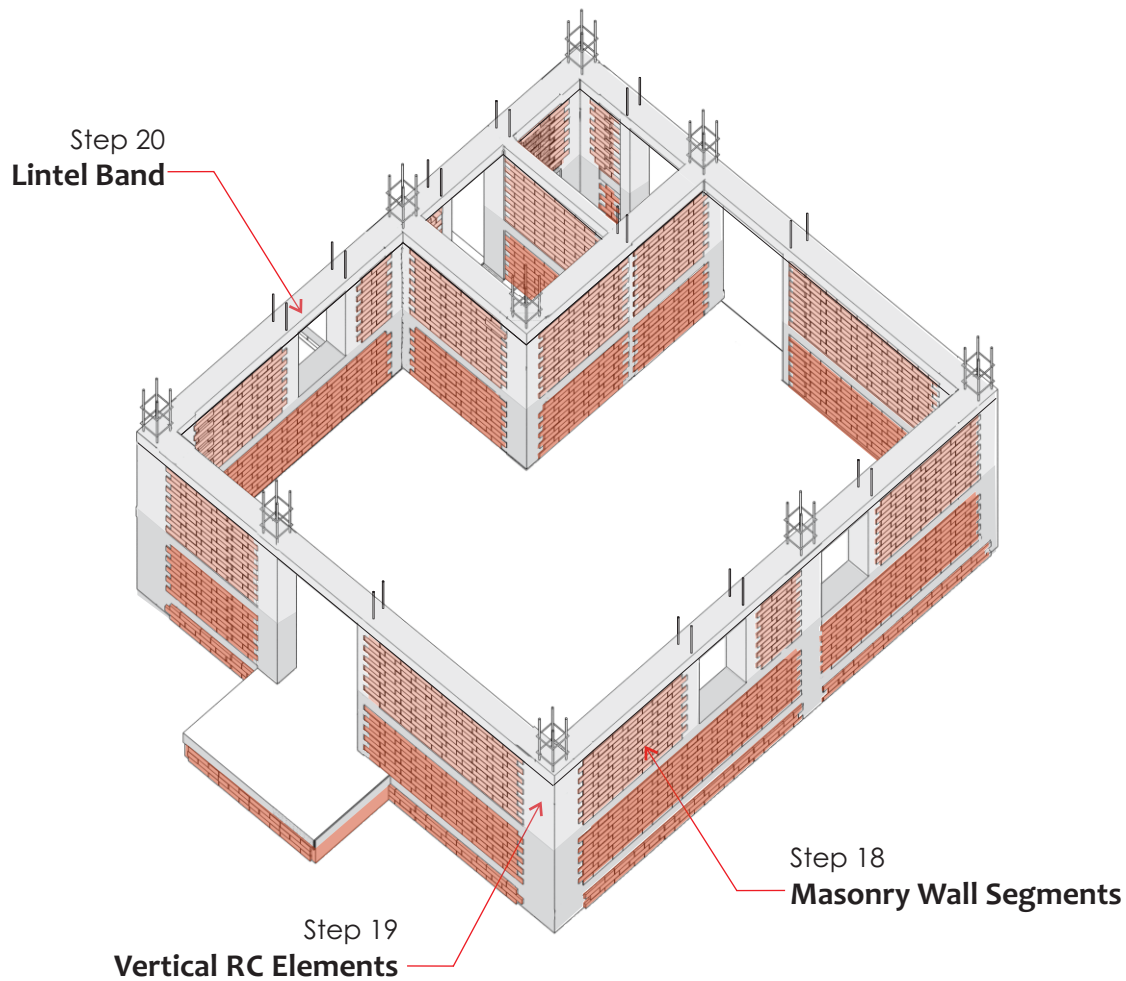

## Step 18

Build masonry wall segments till 75 mm below lintel level.

## Step 19

Pour concrete (1:2:4 mix of cement, sand and aggregate) of vertical RC elements around steel reinforcement grill up to the level of top masonry course.

## Step 20

Place the steel reinforcement cage and pour concrete (1:2:4 mix of cement, sand and aggregate) for Lintel Band.

# Walls

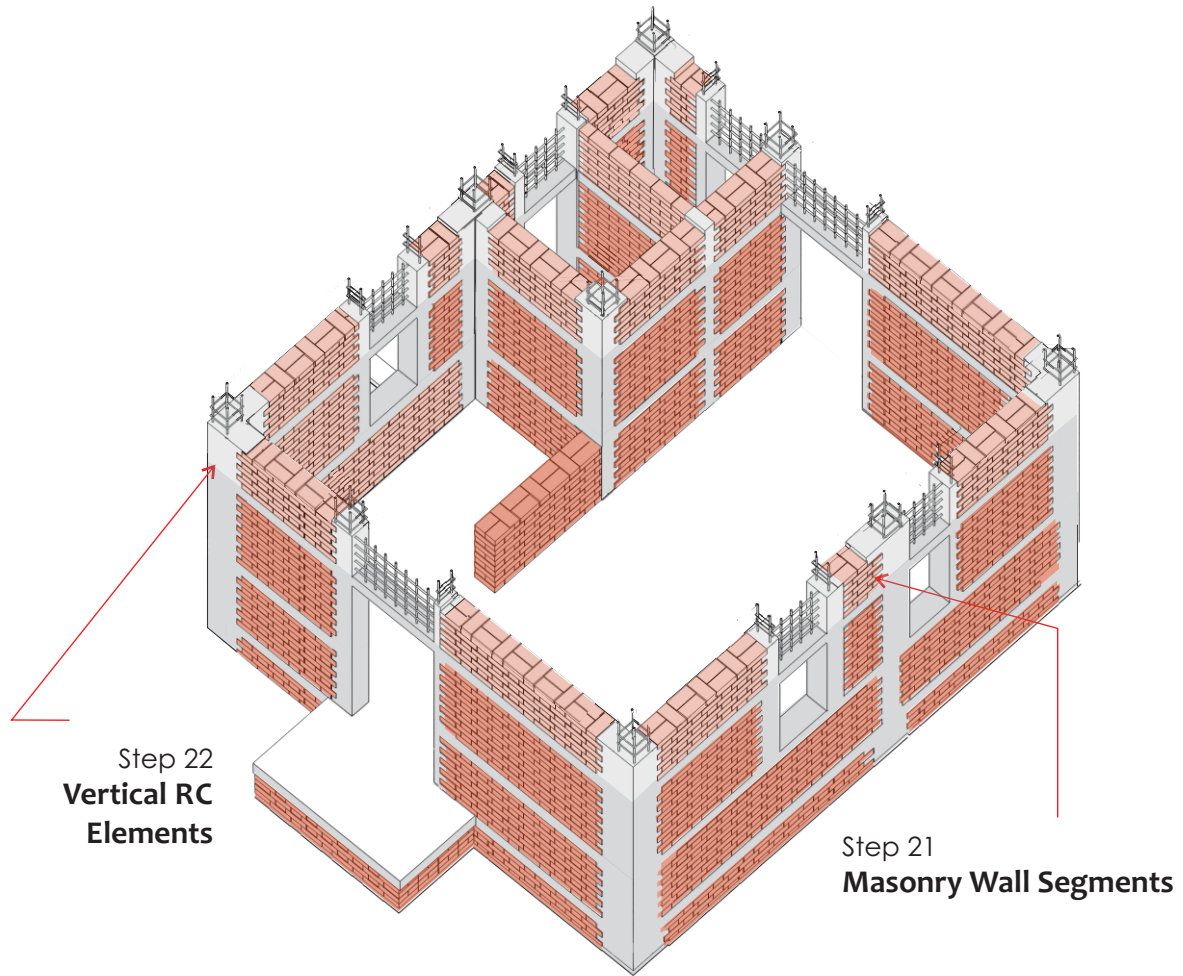

## Step 21

Build masonry wall segments with cement mortar (1 : 4 mix of cement and sand) till the soffit of the roof slab

## Step 22

Pour concrete (1:2:4 mix of cement, sand and aggregate) around steel reinforcement cage of vertical RC elements up to the level of top masonry course.

# Walls

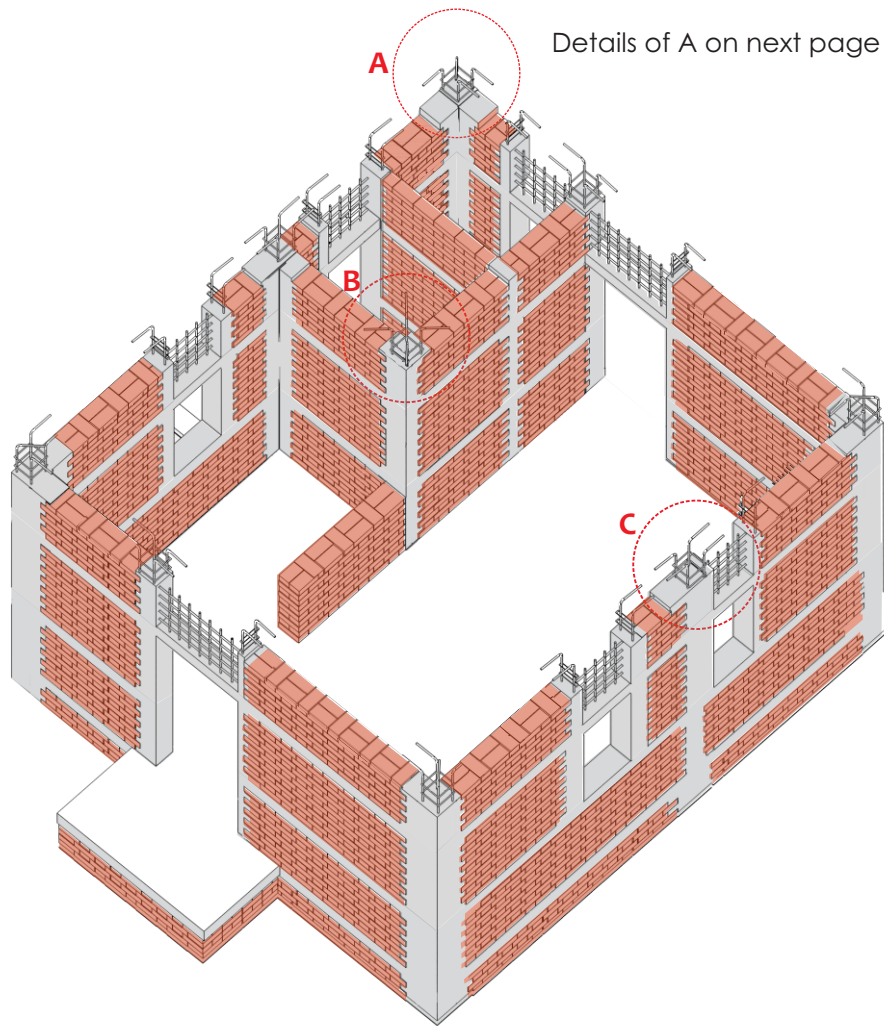

## Step 23

Bend longitudinal bars of vertical RC elements at the ends into the roof slab

# Walls

How do I bend reinforcement bars into roof slab?

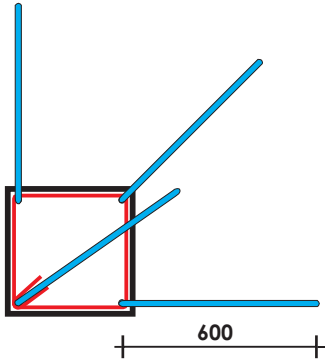
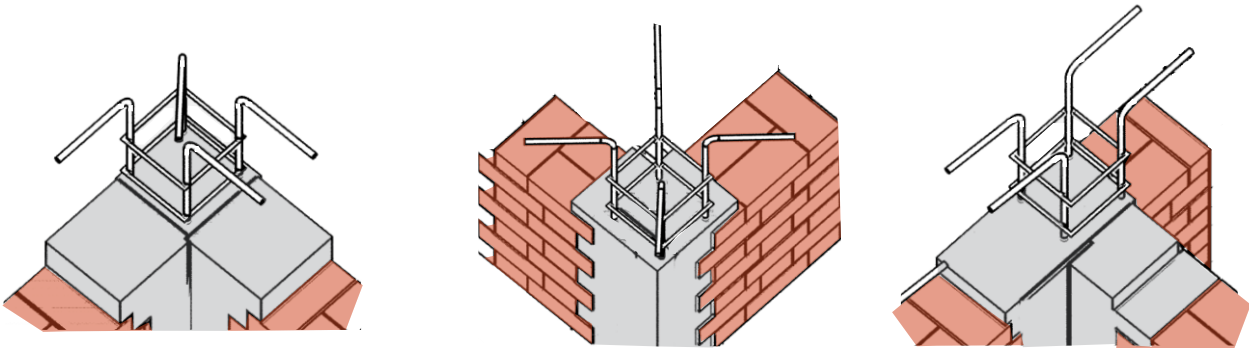

Wall Corner  
Detail A

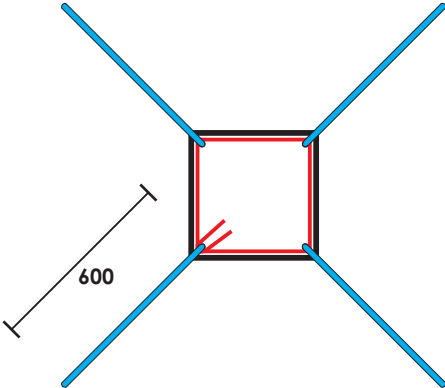

Inside Wall  
Detail B

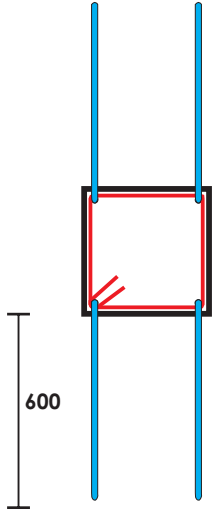

Wall Edge  
Detail C

## Walls

For the construction of Superstructure till Roof Level, the materials required are:



### Cement

30 bags



### Sand

2.5 m<sup>3</sup>



### Aggregates

20 mm (Nominal) : 1.5 m<sup>3</sup>



### Steel

High Strength Steel : 260 m of **10** mm diameter bars  
Mild Steel : 230 m of **6** mm diameter bars

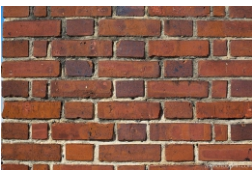

### Burnt Clay Bricks

4,200



# Roof

## How do I Build my house with a Flat roof

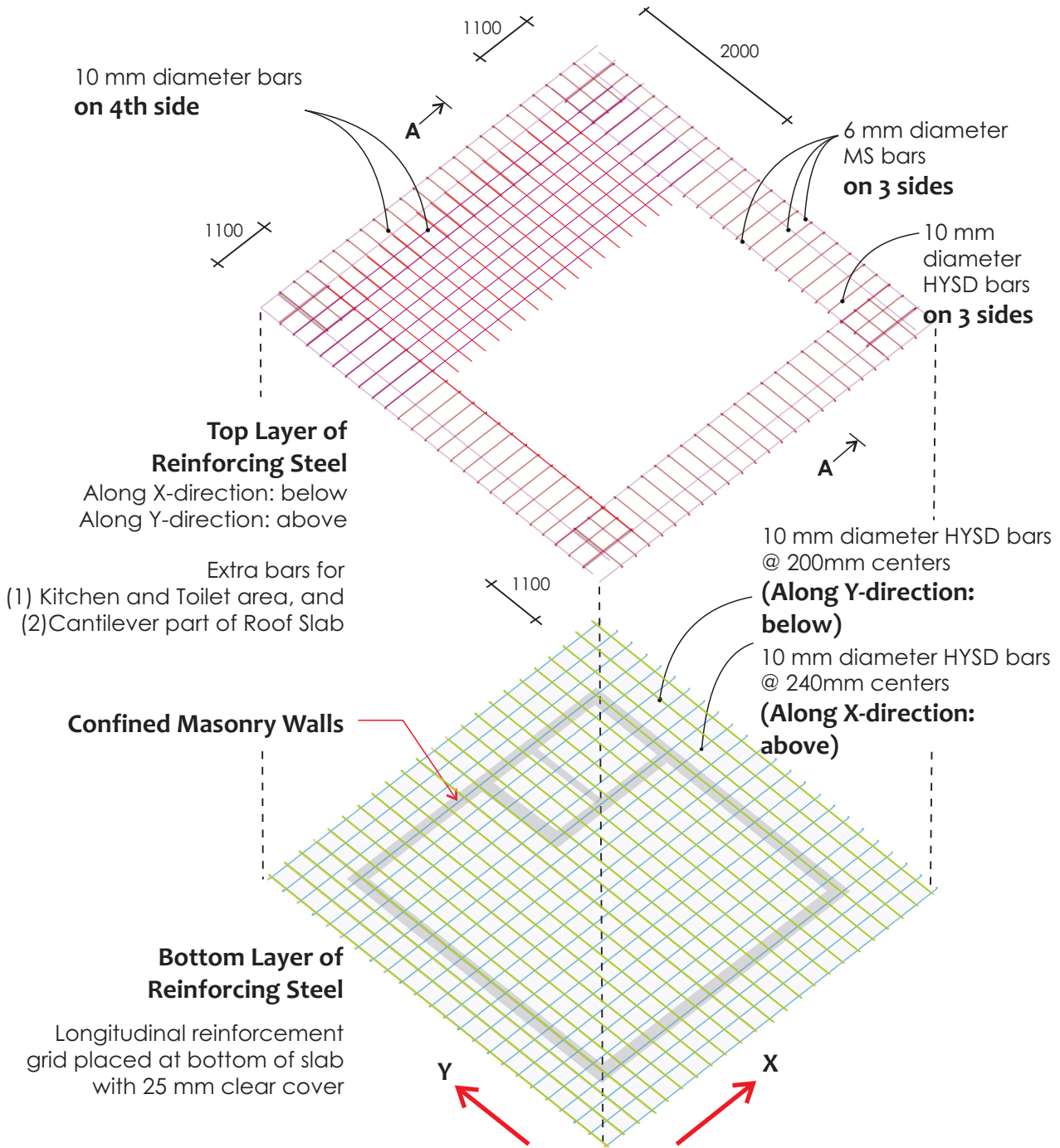

### Step 24

Place reinforcement cage of RC roof slab

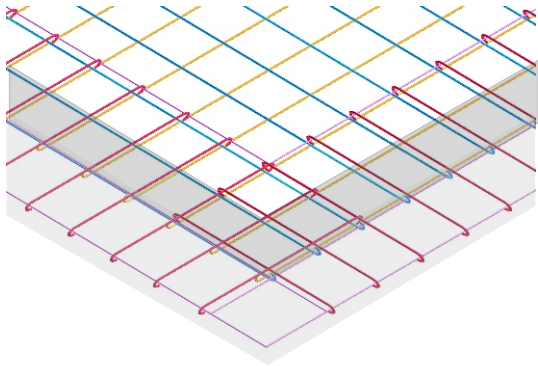

Reinforcement at Slab Corner Edge

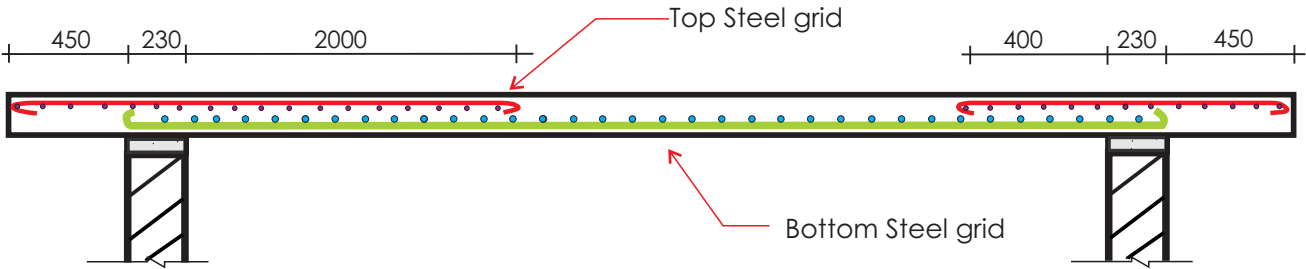

Section A-A

## Roof

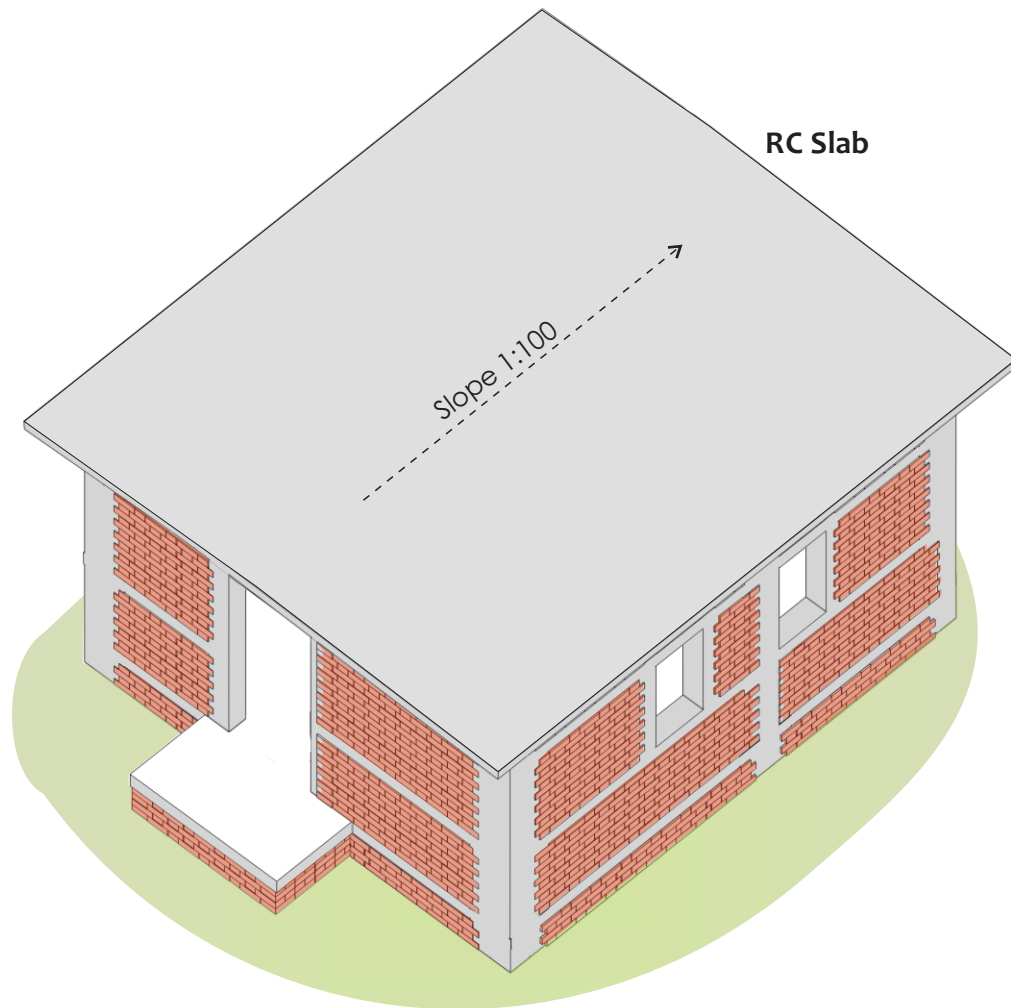

### Step 25

Pour concrete (1:1  $\frac{1}{2}$ :3 mix of cement, sand and aggregates) of RC flat roof. Finish top surface with a gentle slope of 1:100 to drain rain water to the back side of the house.

# Roof

Mortar bunds to pond water

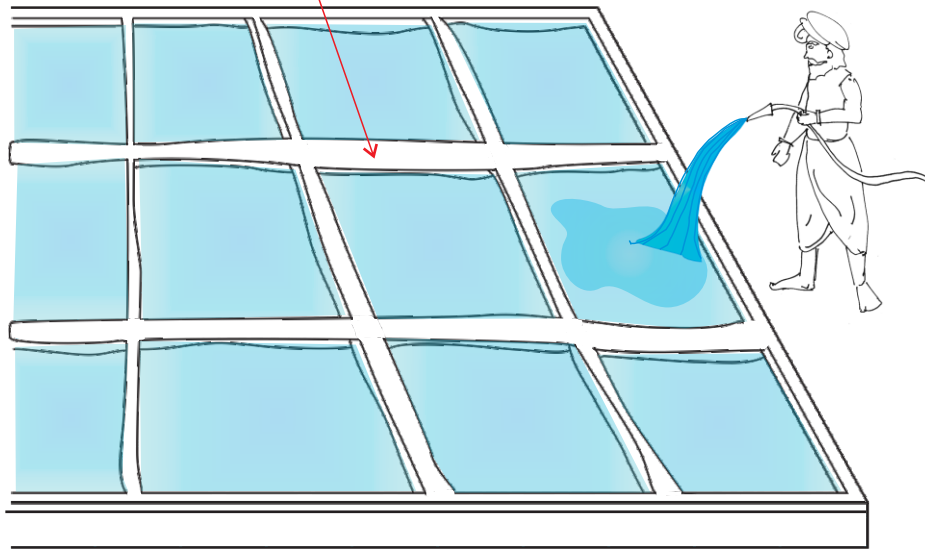

## Step 26

Cure concrete in flat roof slab after a day of casting. To hold the water, make small bunds of 25mm height to break the large slab into smaller ponds; use 1:8 cement-sand mortar for making these bunds. Water the slab for 28 days.

# Roof

For the construction of Roof, the materials required are:



## Cement

26 bags



## Sand

1.1 m<sup>3</sup>



## Aggregates

20 mm (Nominal) : 2.1 m<sup>3</sup>



## Steel

High Strength Steel : 500 m of **10** mm diameter bars  
Mild Steel : 60 m of **6** mm diameter bars



## Burnt Clay Bricks

None

## Roof

## How do I build my house with a sloping roof

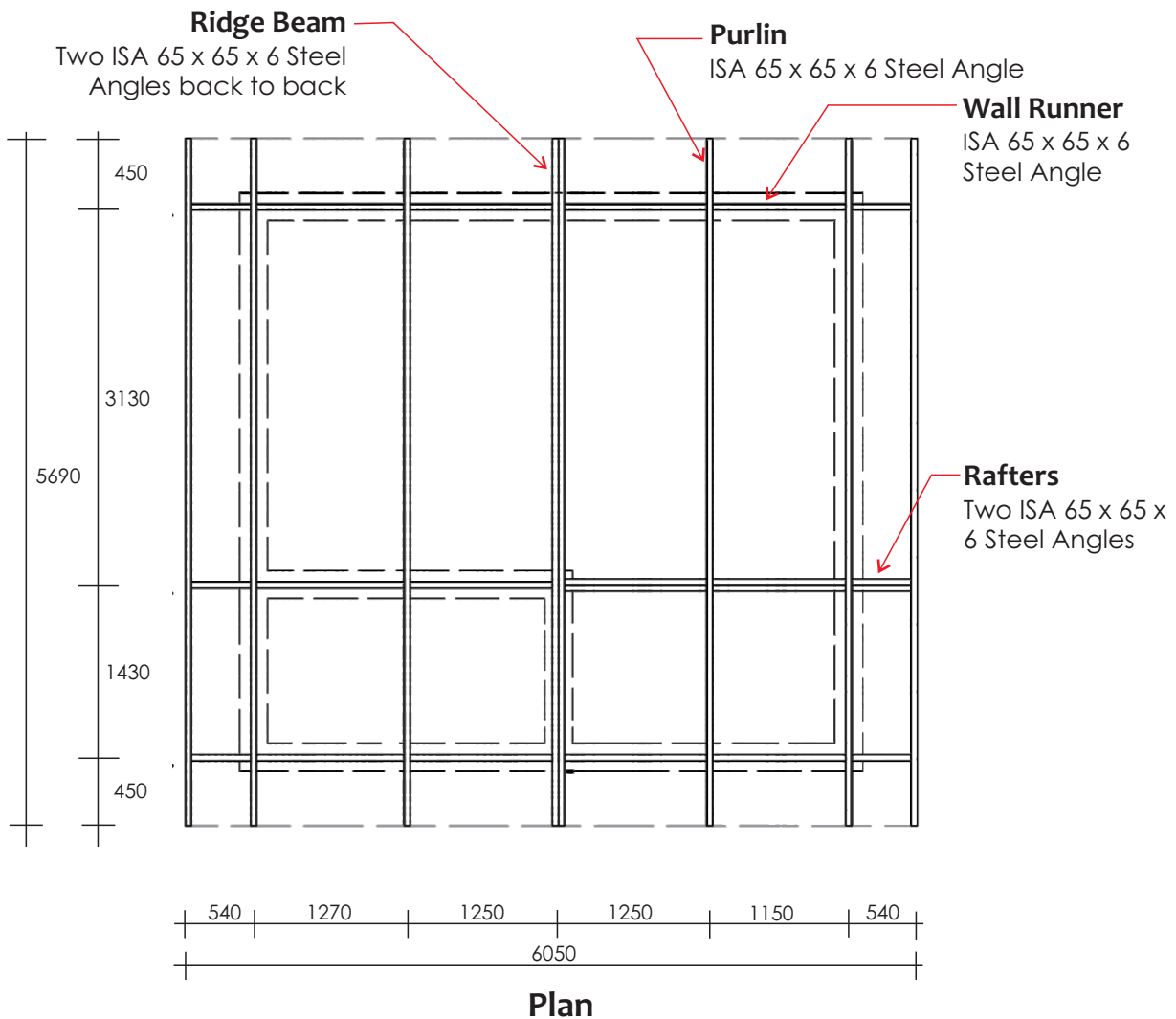
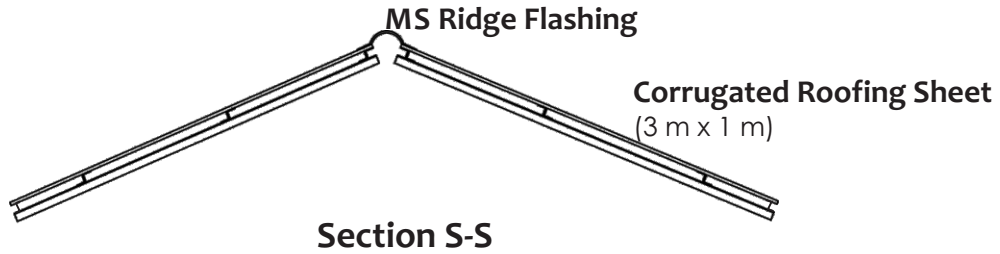

# Roof

Corrugated Metal Roofing Sheets (1 m x 3 m)

Metal Ridge Flashing

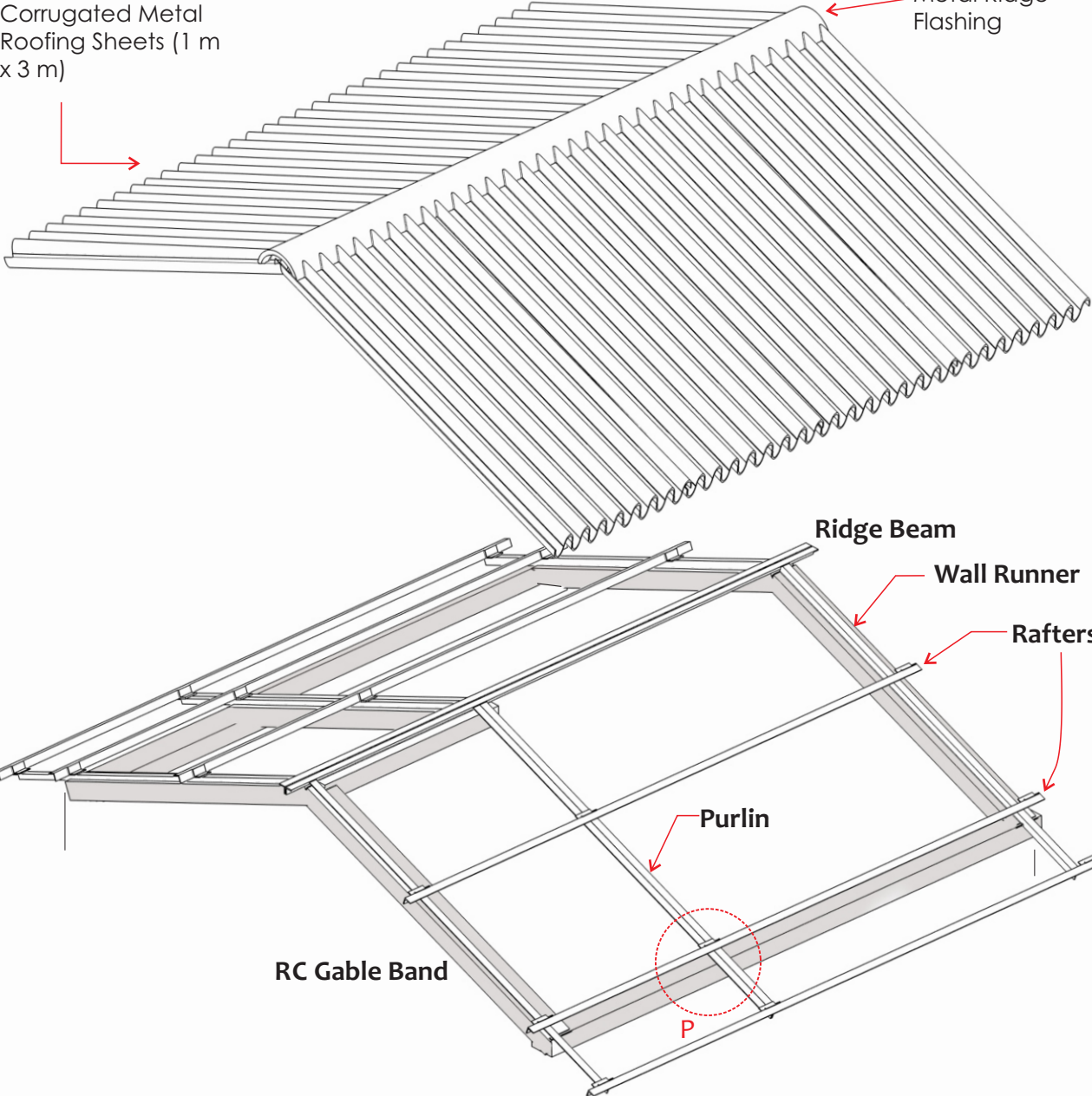

Perspective View

# Roof

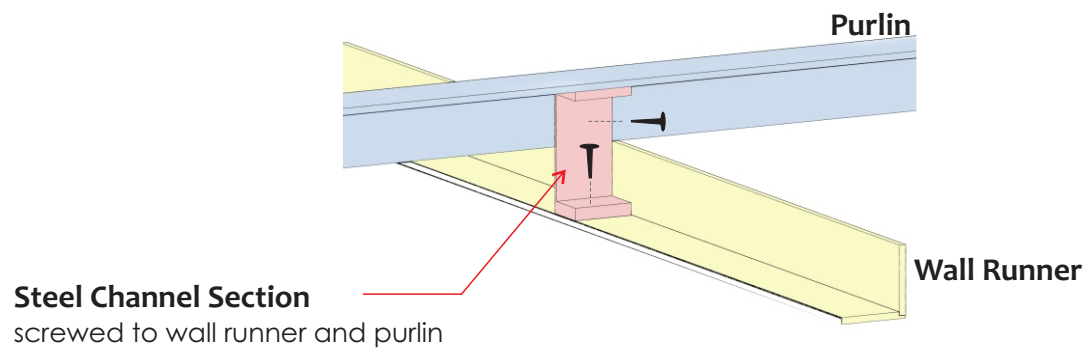

# Material required to build the complete house

For the construction of entire house, the materials required are:



## Cement

92 bags



## Sand

10.4 m<sup>3</sup>



## Aggregates

20 mm (Nominal) : 6.7 m<sup>3</sup>



## Steel

High Strength Steel : 940 m of **10** mm diameter bars  
Mild Steel : 480 m of **6** mm diameter bars



## Burnt Clay Bricks

7800



## Water

~1,630 liters for mortar and concrete  
Extra for curing





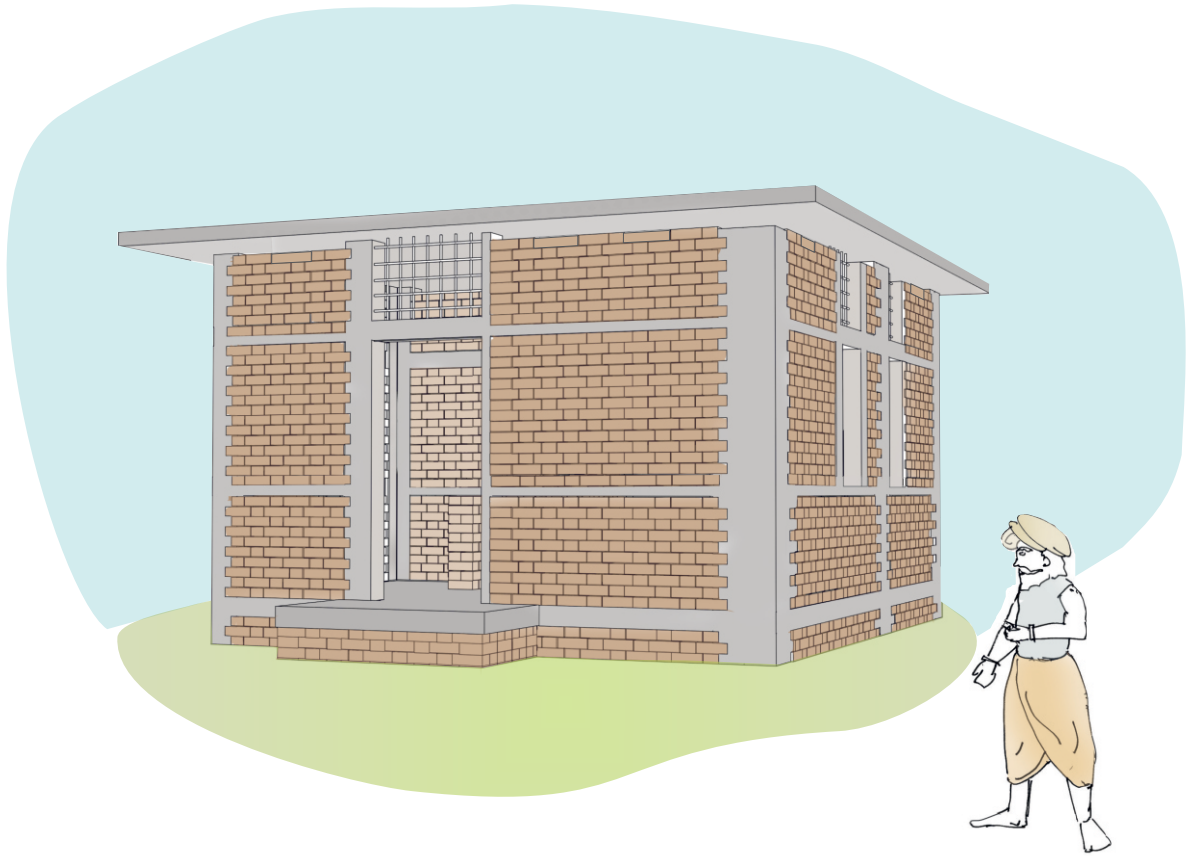

## Confined Masonry House

Burnt clay brick masonry walls  
RC vertical elements and horizontal bands  
RC flat roof  
: Walls first, RC elements next