

How to build safer houses with confined masonry

Praise for this book

'This book is a great example of something good emerging from the tragedy of the 2010 Haiti earthquake. The existing reinforced concrete and masonry construction was essentially destroyed. So now, the safe alternative - confined masonry is explained in a way that masons can engage with. In a step-by-step detailed approach readers are instructed in how to build a house in confined masonry.

With its focus upon the practical skills and orientation of its readership almost all the content of the book is conveyed, not through text, but through attractive and well-annotated drawings. Even when communicating technical principles, a simple analogy gets the messages across.

This book warrants wide international dissemination to educate masons and others in the safest way to build houses using the most commonly available construction materials, reinforced concrete and masonry.'

*Andrew Charleson, Associate Professor
in Building Structures, Victoria University of Wellington*

'This unique guide illustrates construction of low-rise confined masonry buildings in a simple and user-friendly manner, and is expected to be an invaluable resource for house owners and builders of confined masonry houses in earthquake prone regions of the world.'

*Dr. Svetlana Brzev, Chair, Confined Masonry Network,
Earthquake Engineering Research Institute*

How to build safer houses with confined masonry

A guide for masons

Nadia Carlevaro, Guillaume Roux-Fouillet
and Tom Schacher

PRACTICAL ACTION
Publishing



Practical Action Publishing Ltd
The Schumacher Centre, Bourton on Dunsmore, Rugby, Warwickshire,
CV23 9QZ, UK
www.practicalactionpublishing.org

© Swiss Agency for Development and Cooperation, 2018

First published by Swiss Agency for Development and Cooperation and
Earthquake Engineering Research Institute 2015

This edition published by Practical Action Publishing 2018

The moral right of the authors to be identified as authors of the work have
been asserted under sections 77 and 78 of the Copyright Designs and Patents
Act 1988.

This open access book is distributed under a Creative Commons
Attribution Non-Commercial Share Alike 4.0 International Licence.

Product or corporate names may be trademarks or registered trademarks,
and are used only for identification and explanation without intent to infringe.

A catalogue record for this book is available from the British Library.
A catalogue record for this book has been requested from the Library of
Congress.

ISBN 978-185339-989-3 paperback
ISBN 978-185339-988-6 hardback
ISBN 978-178044-988-3 library pdf
ISBN 978-178044-989-0 epub

Citation: Carlevaro, N. Roux-Fouillet, G and Schacher, T., (2018) *How to build
safer houses with confined masonry: A guide for masons*, Rugby, UK: Practical
Action Publishing <<http://dx.doi.org/10.3362/9781780449883>>

Since 1974, Practical Action Publishing has published and disseminated books
and information in support of international development work throughout the
world. Practical Action Publishing is a trading name of Practical Action Publish-
ing Ltd (Company Reg. No. 1159018), the wholly owned publishing company of
Practical Action. Practical Action Publishing trades only in support of its
parent charity objectives and any profits are covenanted back to Practical
Action (Charity Reg. No. 247257, Group VAT Registration No. 880 9924 76).

The views and opinions in this publication are those of the author and do not
represent those of Practical Action Publishing Ltd or its parent charity
Practical Action. Reasonable efforts have been made to publish reliable data
and information, but the authors and publisher cannot assume responsibility
for the validity of all materials or for the consequences of their use.

Cover photo: A mason at work

Cover design: RCO.design

Credit: www.123RF.com Photographer: Patricia Hofmeester - The Netherlands

Typeset by vPrompt eServices, India

Printed in the United Kingdom

Contents

<i>Preface</i>	x
<i>Acknowledgments</i>	xi
<i>About the authors</i>	xii
INTRODUCTION	01
1. THE MASON'S WORLD	03
Masonry tools 1	04
Masonry tools 2	05
Formwork tools	06
Steel reinforcement tools	07
Quality of materials	08
Storage of building materials on site	09
Construction site protection	10
2. CONFINED MASONRY FOR TWO-STOREY HOUSES	11
Confining elements (ties)	12
A strong house	13
Shape of the house	14
Shear walls	15
Seismic gap	16
Vertical continuity of walls	17
3. FINDING AN ADEQUATE LOCATION	19
Site selection: where to build	20
Flood-related hazards	21
Building on a slope	22

4. LAYOUT	23
Site preparation	24
Tracing a right angle (3:4:5)	25
Layout	26
5. STONE FOUNDATION	27
Excavation	28
Foundation dimensions	29
Special foundations	30
Stepped foundations	31
Stone masonry construction	32
Reinforced concrete strip footing	33
Curing and ground floor	34
Placing sewage pipes	35
6. REINFORCED CONCRETE TIES	37
Types of steel rebars	38
Stirrups	39
Alternate stirrup positions	40
Stirrup spacing	41
Lap length	42
Tie-beam: T-connection	43
Tie-beam: L-connection	44
Tie-beam to tie-column connection	45
Protection of rebar ends	46
7. FORMWORK	47
Formwork for ties	48
Vertical formwork	49
Horizontal formwork	50
Spacers - 1	51
Spacers - 2	52

8. CONCRETE	53
Concrete mix (1:2:3)	54
Mixing concrete	55
Concrete test	56
Slump test	57
Pouring and compacting concrete	58
Compacting with a vibrating needle	59
Curing the concrete elements	60
Ensure good-quality concrete	61
9. BRICKS AND BLOCKS	63
Which clay bricks to use	64
Brick test	65
Which concrete blocks to use	66
Block test	67
Concrete mix for blocks (1:4:3)	68
Making the blocks	69
10. MASONRY WALLS	71
Cement mortar mix (1:4)	72
Cement-lime mortars	73
Masonry walls height	74
Masonry bonds	75
Toothing	76
Preparing the masonry units	77
Good masonry practice - 1	78
Good masonry practice - 2	79
Placing pipes in walls	80

11. SEISMIC REINFORCEMENTS	81
Vertical reinforcement of openings	82
Door reinforcement	83
Reinforcement of small windows	84
Reinforcement of large windows	85
Horizontal reinforcements (seismic bands)	86
Seismic bands	87
Connections	88
Reinforcement of small windows	89
Reinforcement of large windows	90
Creating shear walls using vertical reinforcements	91
Shear walls with horizontal bands 1	92
Shear walls with horizontal bands 2	93
12. SLAB	95
Placing of slab reinforcement	96
Hollow block slab: formwork	97
Hollow block slab: main reinforcement	98
Hollow block slab: secondary rebars	99
Placing pipes in hollow block slabs	100
Preparing the slab for concrete	101
Pouring the concrete	102
13. LIGHT ROOF	103
Roof shape	104
Gable wall	105
Roof structure - trusses	106
Cyclones	107
Fastening of the veranda framing	108
Fastening of the roof structure	109
Bracing	110

14. RETAINING WALLS	111
Where to build with retaining walls	112
Rule 1 - Wall footing	113
Rule 2 - Slope of the wall (5:1)	114
Rule 3 - Dimensions of the wall	115
Rule 4 - Placing the stones	116
Rule 5 - Through-stones (or bands)	117
Rule 6 - Drainage	118
Retaining wall - Confining elements	119
Gabion retaining walls 1	120
Gabion retaining walls 2	121
15. CONSTRUCTION DRAWINGS	123
Reading plans	124
Reading sections	125
Plan dimensions	126
Section dimensions	127

PREFACE

This guide was originally developed by the Competence Center for Reconstruction of the Swiss Agency for Development and Cooperation (SDC) after the devastating January 2010 Haiti earthquake.

It was developed as a resource for the mason training programme for developing confined masonry construction skills. This training was launched as a response to the urgent need to establish an earthquake-resistant construction practice in Haiti. Its main purpose was to improve workmanship in areas where housing re-construction occurred without technical input.

This guide is regularly used at construction sites and as a resource material for mason training programmes. It offers simple but essential advice on building safer houses using the confined masonry construction technique.

This version of the Guide was adapted by SDC together with members of the Confined Masonry Network of the Earthquake Engineering Research Institute (EERI) for use in various countries and regions of the world.

It is hoped that this resource, originally developed in Haiti, will be useful in other countries facing similar challenges. It is intended for use by local governmental and non-governmental organizations, international humanitarian and development agencies, and most importantly skilled and unskilled masons around the world.

ACKNOWLEDGMENTS

All illustrations are by the authors and by other architects of the Competence Centre for Reconstruction of the Swiss Agency for Development and Cooperation (SDC) in Haiti, Martin Siegrist and Dorothee Hasnas.

We would like to thank those who gave their time and expertise to review this book: Dr Svetlana Brzev and Eng Tim Hart of the Confined Masonry Network (EERI); Marjorie Greene and Maggie Ortiz of EERI; Dr Andrew Charleson of the World Housing Encyclopedia (EERI) and Earthquake Hazard Centre.

ABOUT THE AUTHORS

Nadia Carlevaro and Guillaume Roux-Fouillet are architects and the founders of mobilstudio, with a decade of humanitarian experience in designing and training on earthquake and cyclone-resilient buildings in Myanmar, Haiti, the Philippines, Nepal and Ecuador. Both work regularly as construction and planning experts for the Swiss Agency for Development and Cooperation (SDC), the International Federation of the Red Cross and Red Crescent (IFRC) and the United Nations Refugee Agency (UNHCR).

Tom Schacher is an architect working regularly with the Swiss Agency for Development and Cooperation and has previously developed manuals and training materials for construction workers on locally appropriate earthquake-resistant construction techniques.

INTRODUCTION

How to Build Safer Houses with Confined Masonry is intended for the training of masons in the technique of confined masonry. It can be used as a guide on construction sites or as a training resource. It is presented in a simple manner and explains in a step-by-step sequence how to build a one or two-storey confined masonry house.

The guide was developed for masons working in countries with very limited financial and technical resources. The recommendations are intended to be conservative (on the safe side) and to ensure the safety of the occupants.

This guide needs to be adapted according to the type and quality of locally available materials and local capacities. The technical recommendations contained in the guide should be in compliance with local construction codes and other regulations (where available).

Illustrations included in the guide may be adapted to suit the local culture and perceptions and to ensure good acceptance. The text may be translated into a local language which the masons are able to read and understand.

While the authors have tried to be as accurate as possible, they cannot be held responsible for construction that might be based on the material presented in this guide. The authors and their organizations disclaim any and all responsibility for the accuracy of any of the material included in the guide.

1. THE MASON'S WORLD

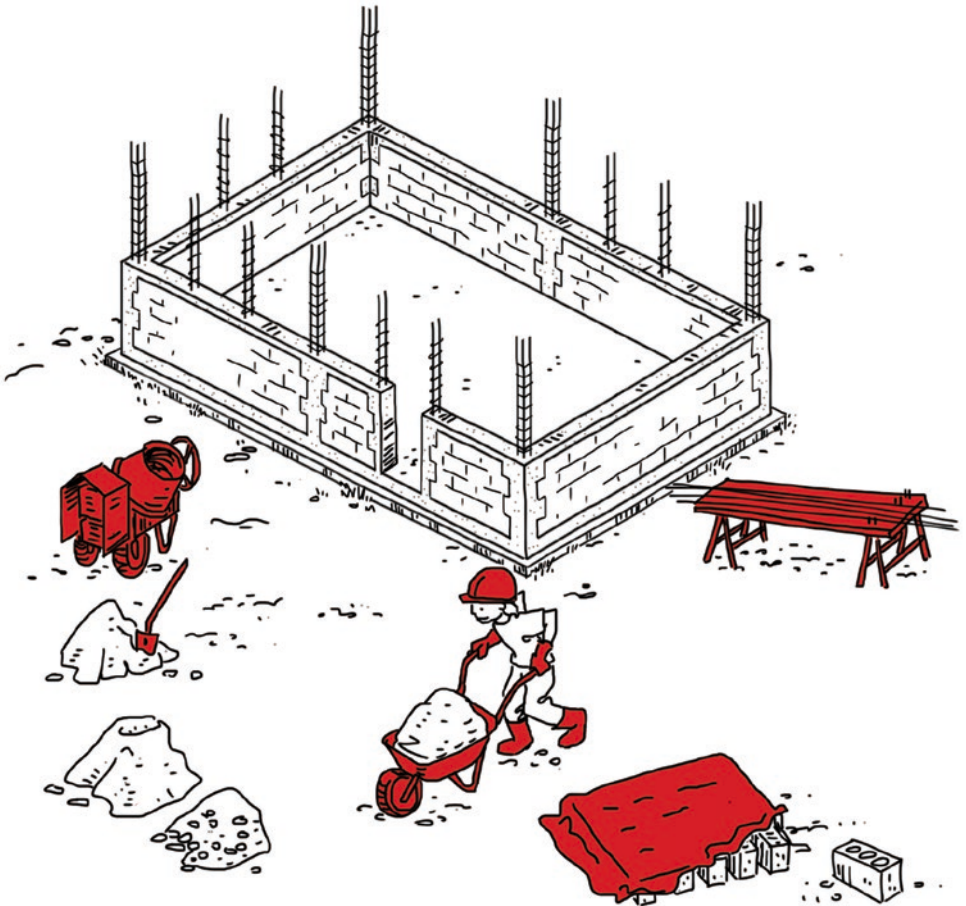

Masonry tools 1



guide book

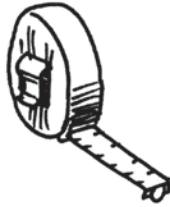

tape measure



straight edge

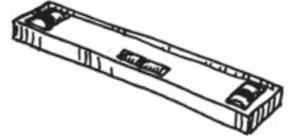

level



pencil



plumb line



string

nail



chalk line

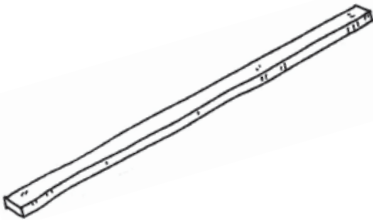

aluminium screed



machete



screen (05, 03)

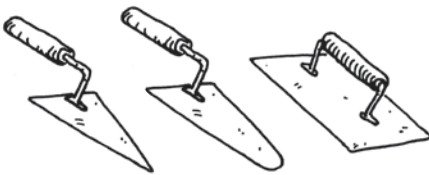

trowel

float



hammer



chisel



club hammer

Masonry tools 2



bucket

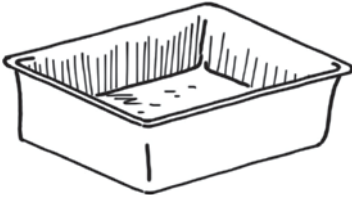

mixing box



cone for slump test



big brush



transparent water hose 10-20 m



pickaxe



shovel

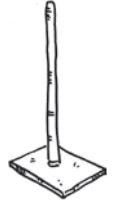

rammer



grinder

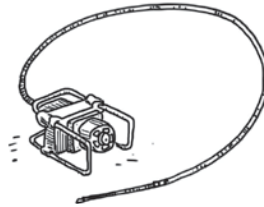

needle vibrator

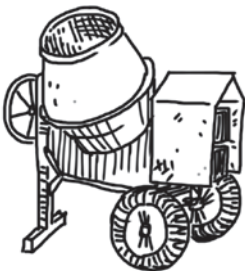

concrete mixer

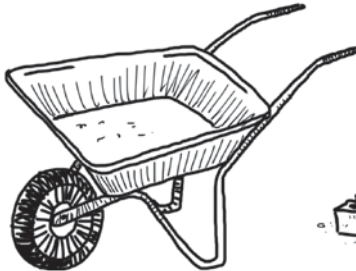

wheelbarrow

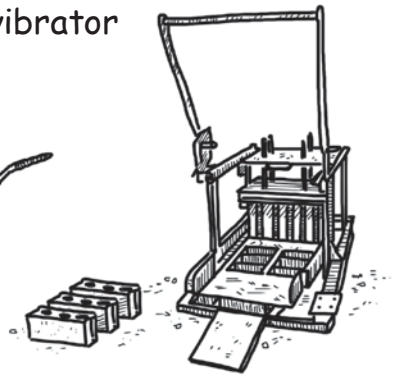

vibrating block/brick press

Formwork tools



guide book

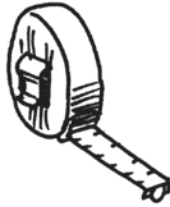

tape measure

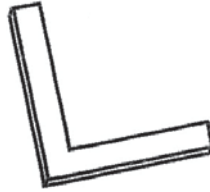

straight edge

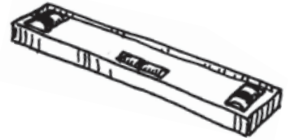

level



pencil



plumb line



string

nail



hammer



chisel



crowbar



axe

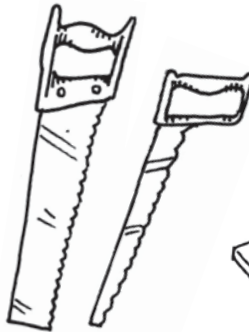

saw

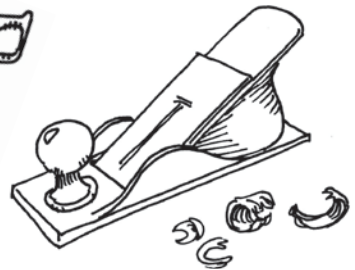

plane

http://www.developmentbookshelf.com/doi/book/10.3362/9781780449883 - Monday, January 22, 2018 6:25:39 AM - IP Address: 193.5.216.100

Steel reinforcement tools



guide book

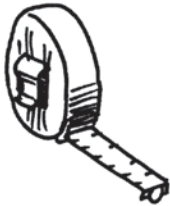

tape measure

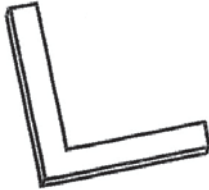

straight edge

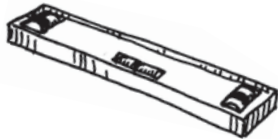

level



pencil



chalk



plumb line



string

nail



wire twister
or pincer



pliers



tin snips



hammer



chisel

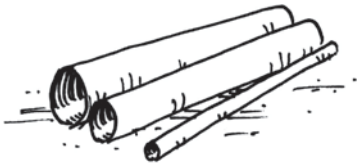

plastic pipes of
different diameters



hacksaw



rebar
bender



chain bolt
cutter

Quality of materials

The quality of materials is essential to ensure safe construction



Water: clean and not salty

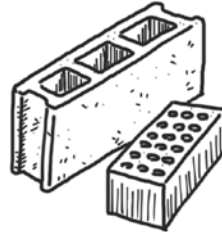

Blocks and bricks: (ch. 9) minimal size and strength



Sand: river sand, washed and dry



Cement: portland cement, new and dry bags



Gravel: crushed or round, from hard rock and clean, well-graded, max size 18-20 mm



Steel bars: standard size, ribbed steel, grade 60 new and not corroded

Storage of building materials on site

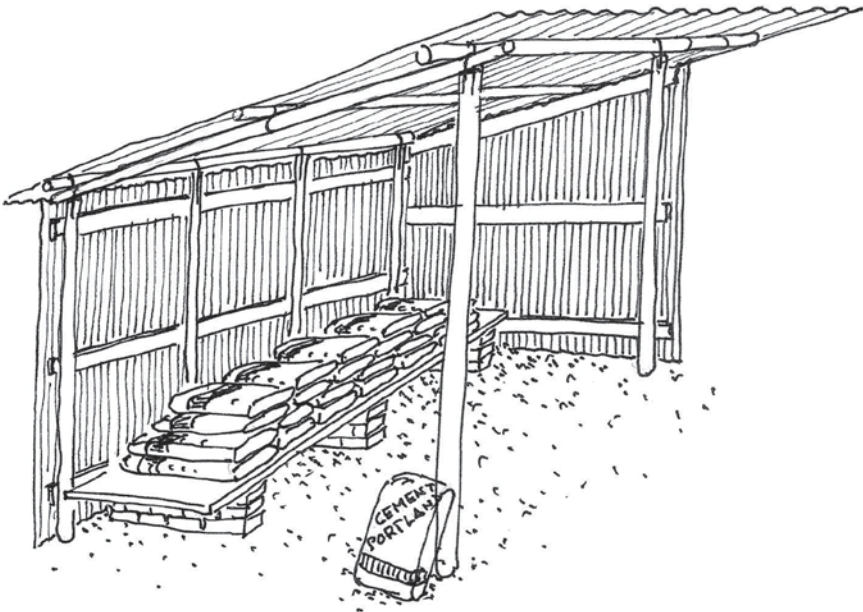

Store cement bags away from the sun and protected from humidity. Do not place on the ground.

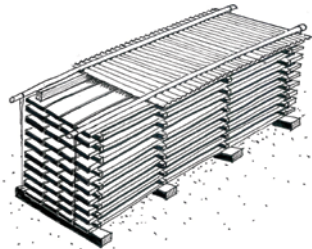
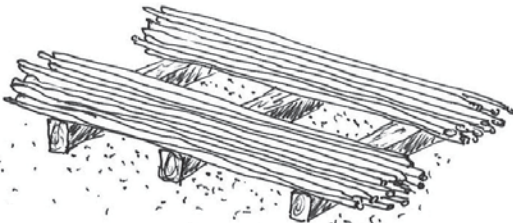

Store wood and steel bars in a dry environment. Do not place on the ground.

Construction site protection

Do not forget that health and security concerns everybody, starting with yourself

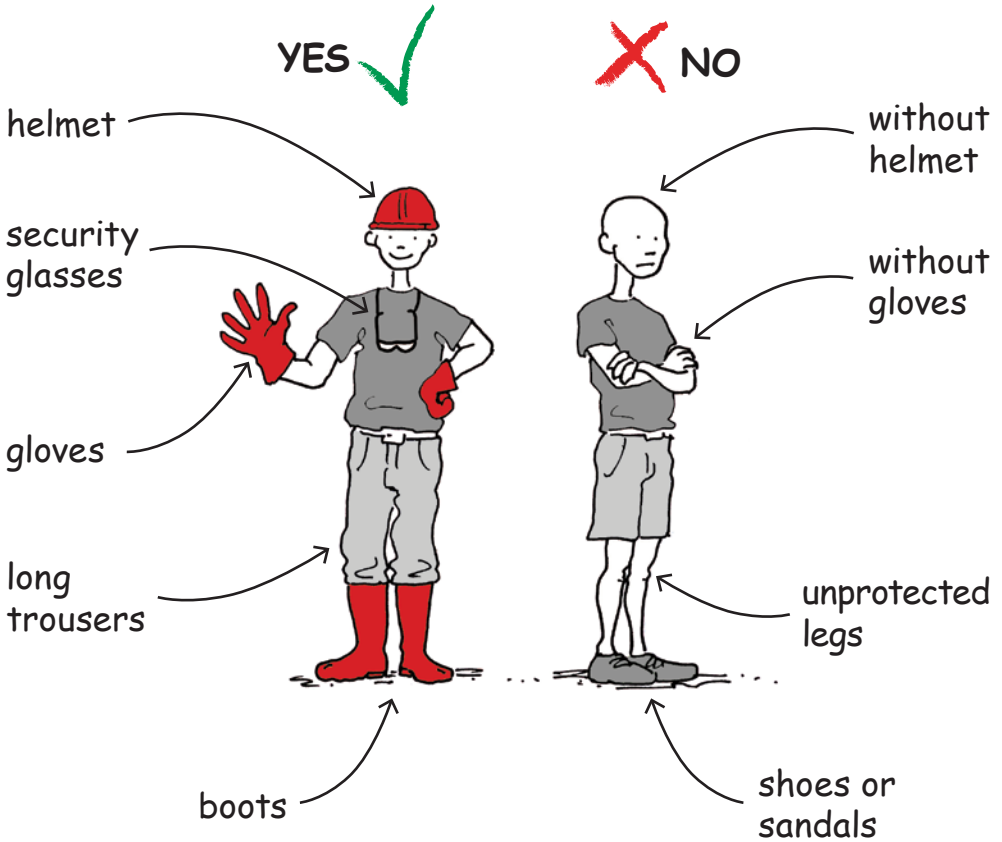

If people are injured on a construction site, wash the wound with clean water and soap and go to a doctor.

2. CONFINED MASONRY FOR TWO-STOREY HOUSES

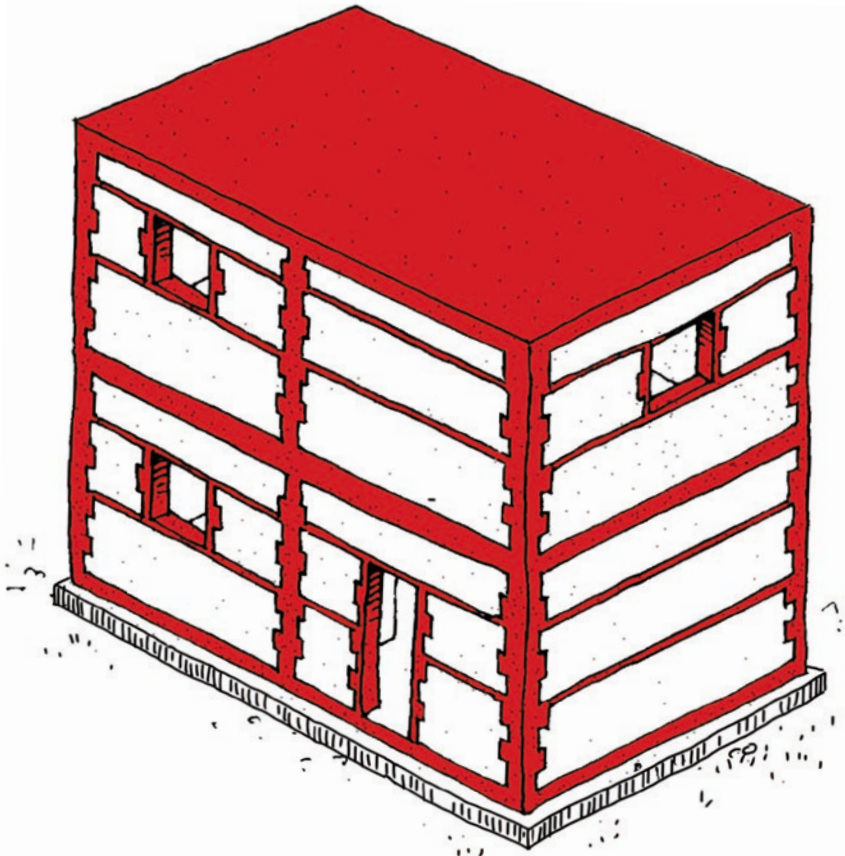

Confining elements (ties)

Confining the walls is like holding a pile of books together with a string: they can still move but they will not fall apart.

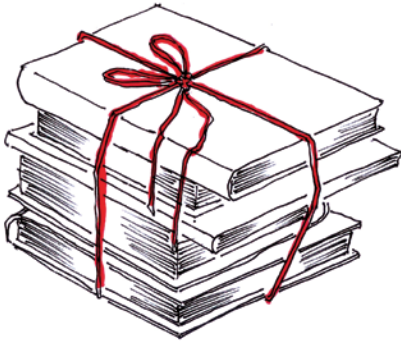

Horizontal ties (tie-beam) and vertical ties (tie-column).

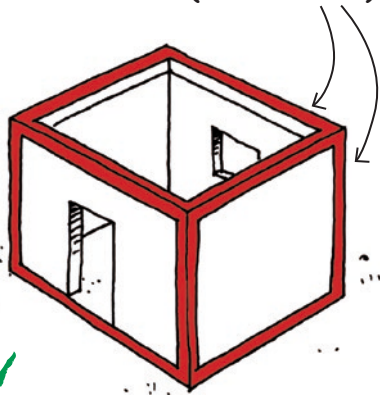

✓ YES

only tie-columns

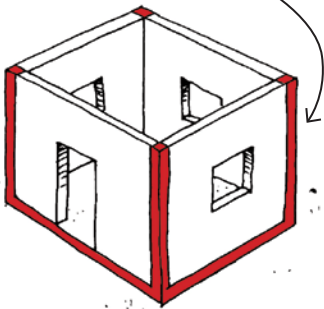

✗ NO

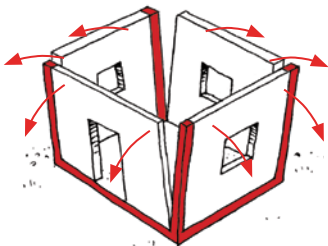

only tie-beams

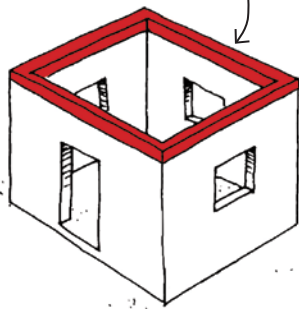

✗ NO

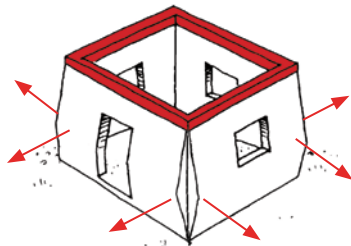

A strong house

All walls and openings should be confined to ensure stability during an earthquake.

Confining elements: (chapters 6-8) tie-column and tie-beams (plinth beam and ring beam)

Anchoring bands and opening reinforcement: (chapter 11) seismic bands (lintel and sill bands) and vertical reinforcement

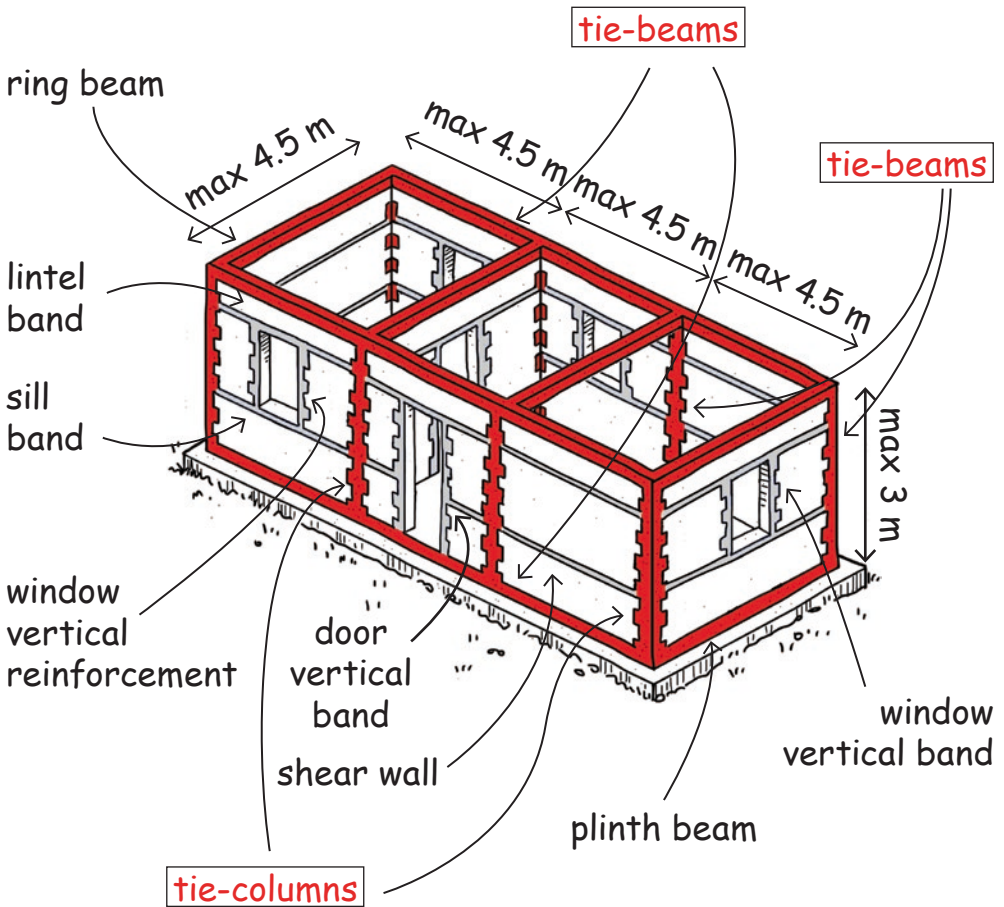

Shape of the house

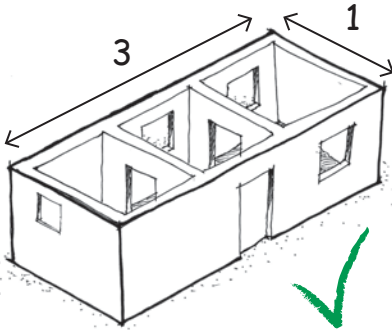

Maximum ratio 1:3.

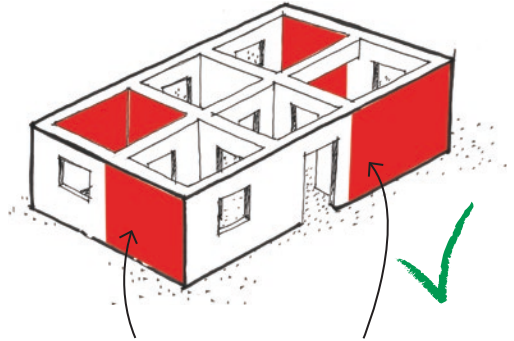

Each facade must have at least one tied wall without openings. These are shear walls.

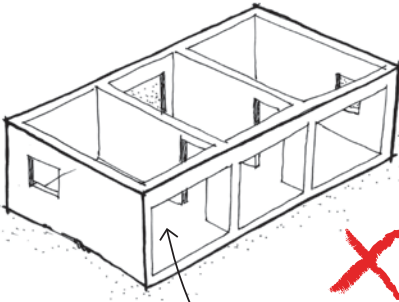

Openings are too big.

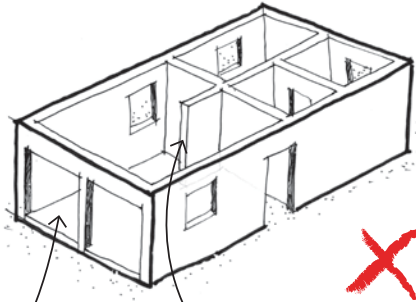

Free standing wall without any tie.

Shear walls

Shear walls are walls without windows or with a small window outside of the diagonals of the wall

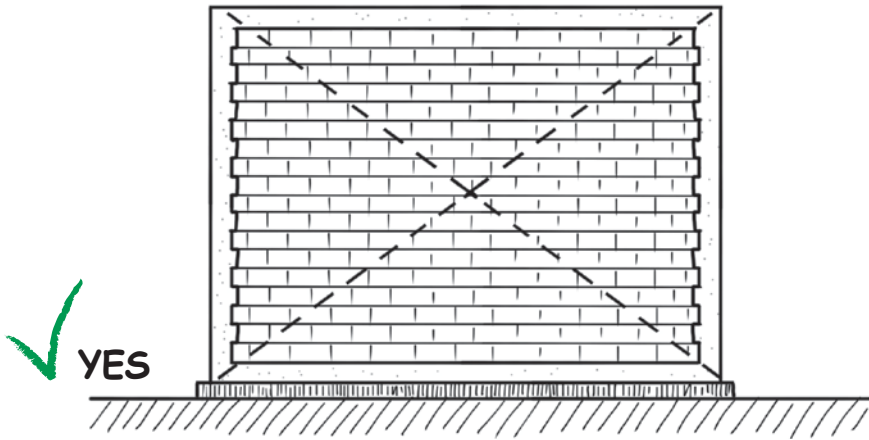

Full shear wall

 NO

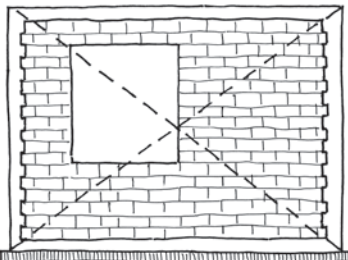

Opening is too big,
crossing the diagonals:
not a shear wall.

 YES

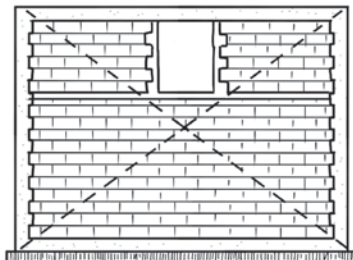

Opening is small and
outside the diagonals:
it is a shear wall.

Seismic gap

Avoid complex shapes by creating seismic gaps.

Simple shape: BETTER

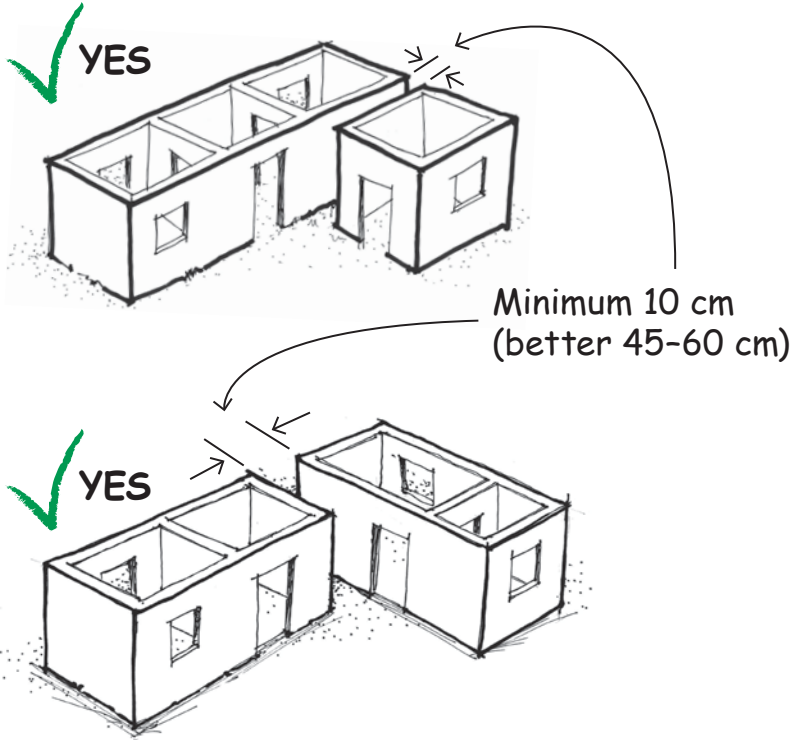

Complex shape: WORSE

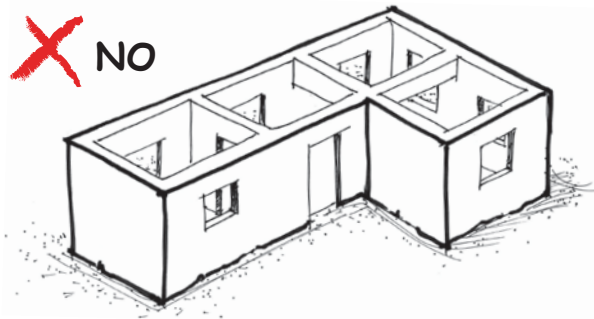

Vertical continuity of walls

✓ YES

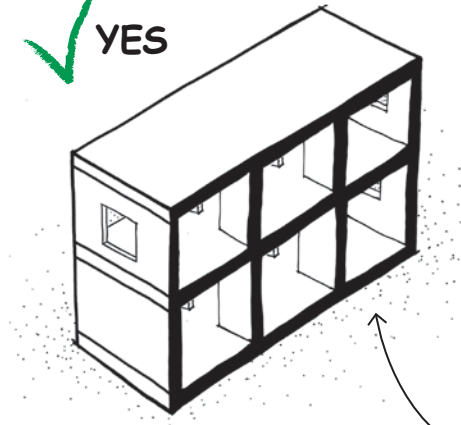

Walls must be placed continuously, one on top of the other from ground to the roof.

✗ NO

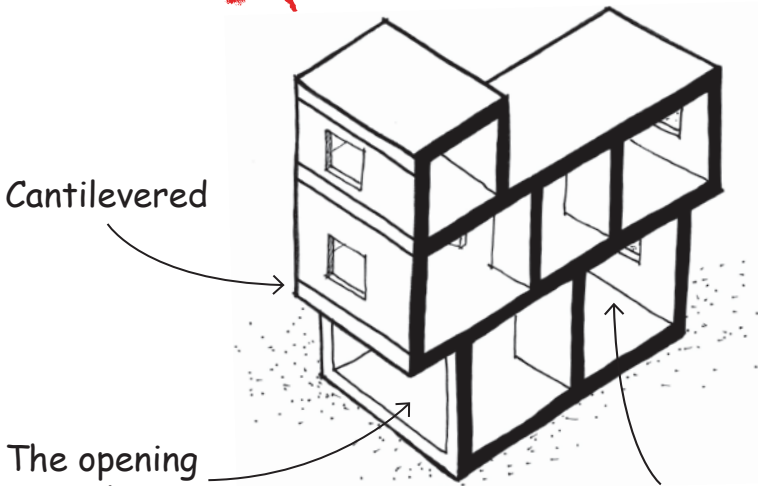

Cantilevered

The opening is too large.

No vertical continuity between the upper and lower wall.

3. FINDING AN ADEQUATE LOCATION

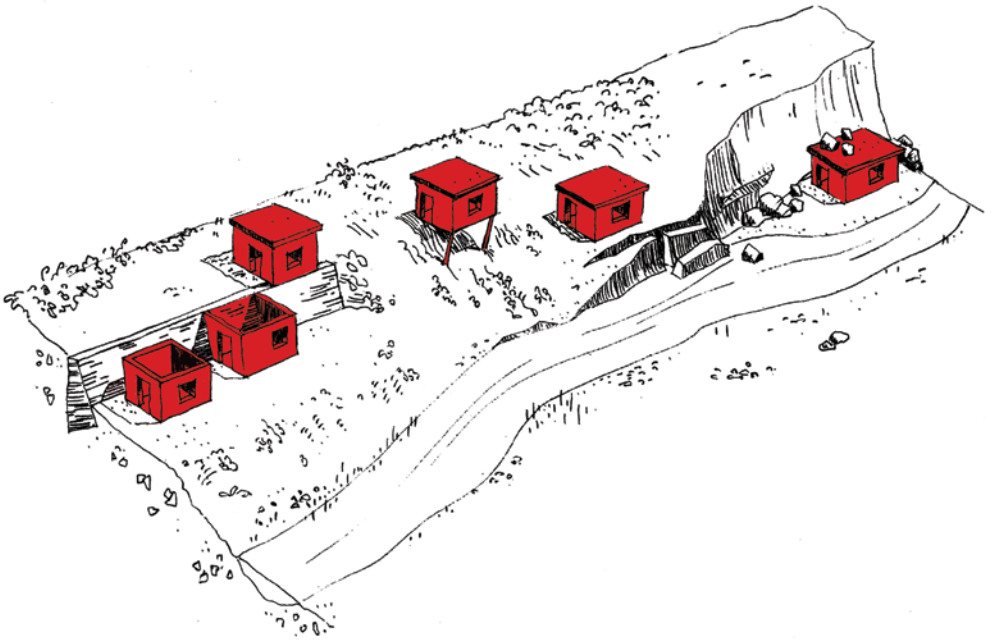

Site selection: where to build

YES ✓

Keep enough distance on each side of the house.

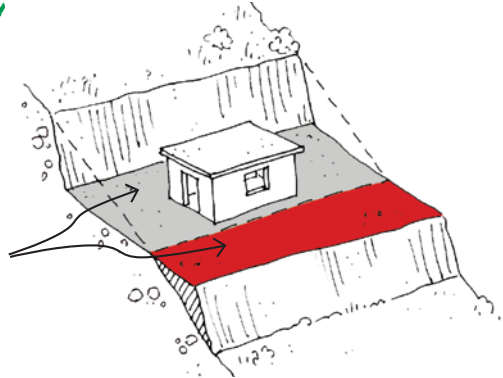

Don't build on embankments.



Don't build on fresh embankments.

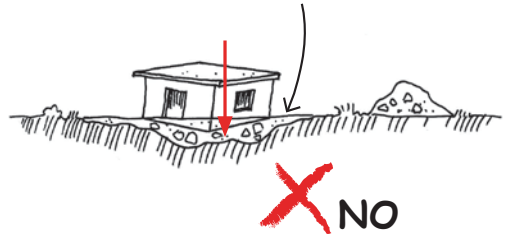

Don't build on stilts.

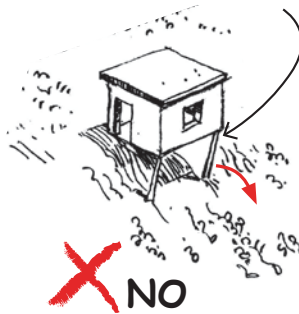

Don't build too close to a cliff.



Don't build at the foot of a cliff.



Flood-related hazards

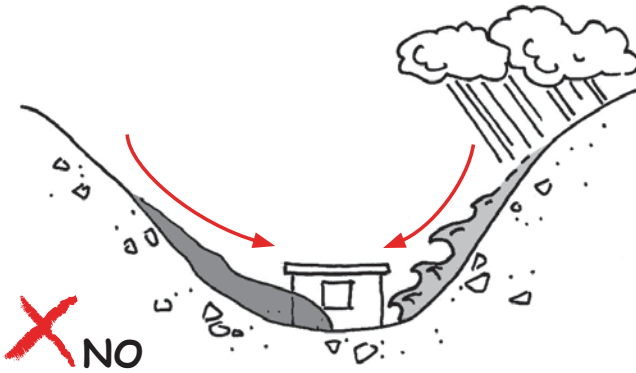

Don't build at the bottom of a canyon.

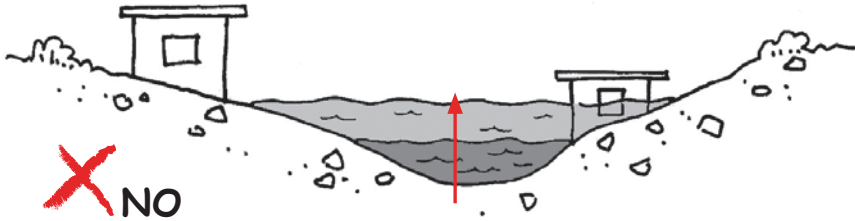

Don't build near a river.



Don't build near the ocean
(due to tsunami risk).

Building on a slope



YES

Build between retaining walls.

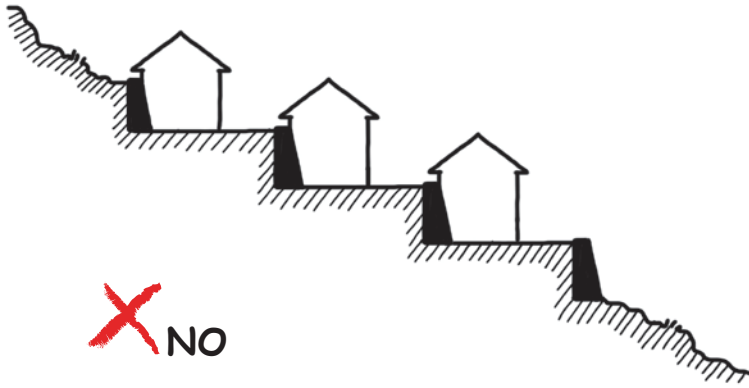

NO

Don't build against a retaining wall.

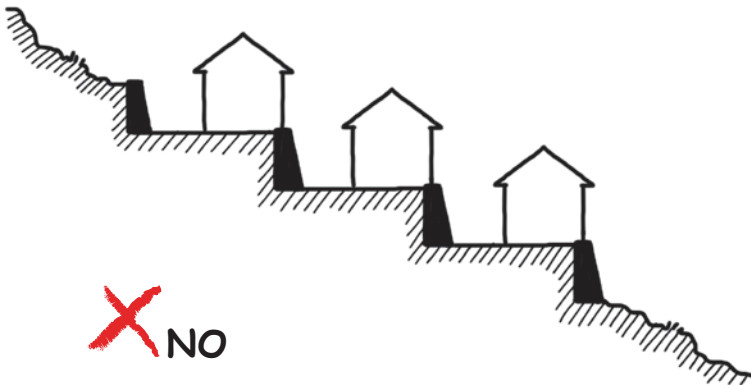

NO

Don't build on top of a retaining wall.

4. LAYOUT

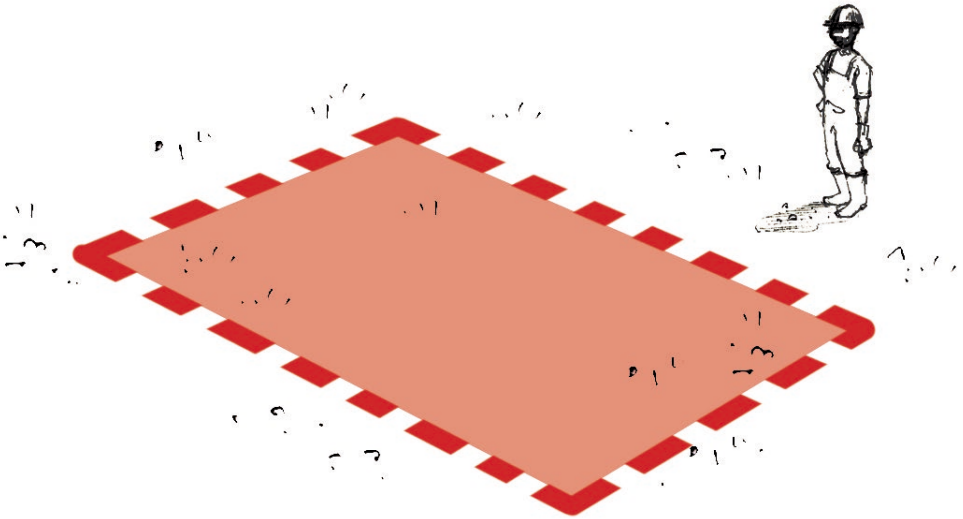

Site preparation

Remove the topsoil and the excavated material, and place it in two (or more) different heaps, away from the excavated area.

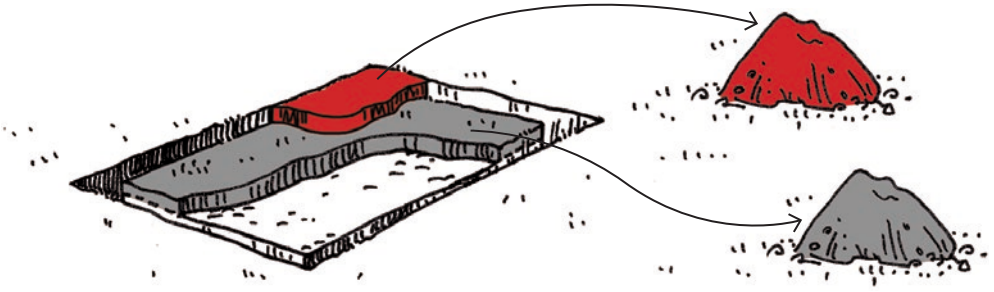

Check whether the ground is level by using a transparent hose filled with water.

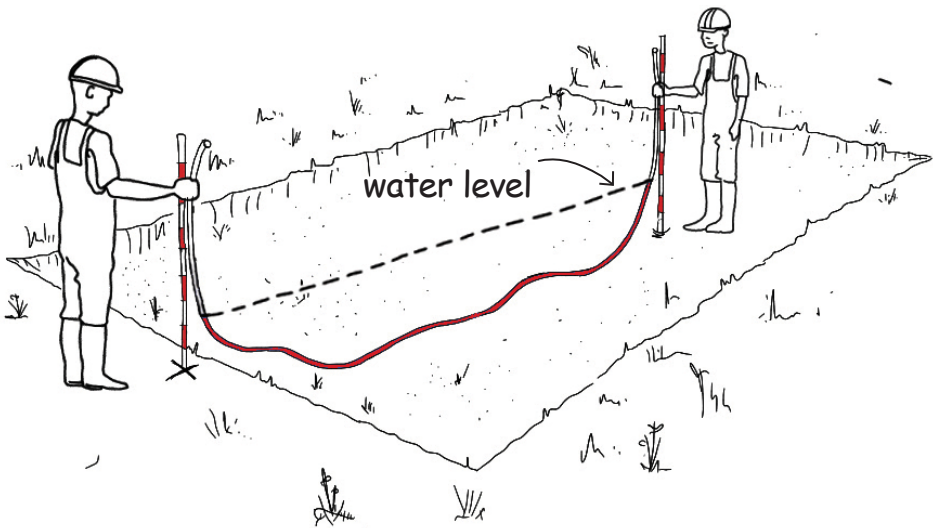

Tracing a right angle (3:4:5)

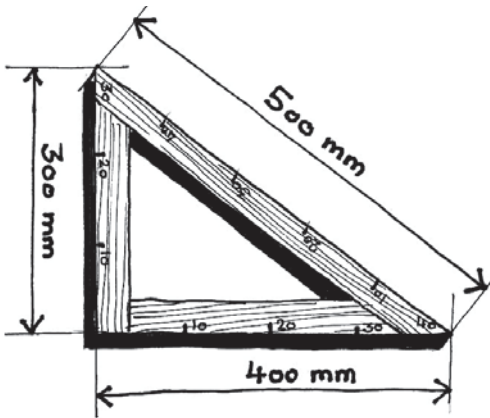
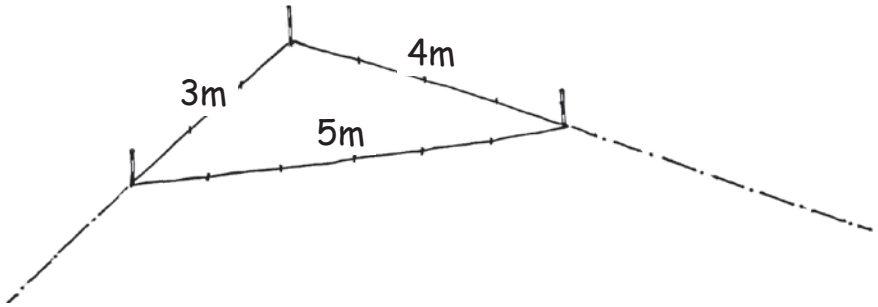

3	4	5
30 cm	40 cm	50 cm
60 cm	80 cm	100 cm
90 cm	120 cm	150 cm
1,5 m	2 m	2,5 m
2,1 m	2,8 m	3,5 m
3 m	4 m	5 m
3 ft	4 ft	5 ft
6 ft	8 ft	10 ft
9 ft	12 ft	15 ft

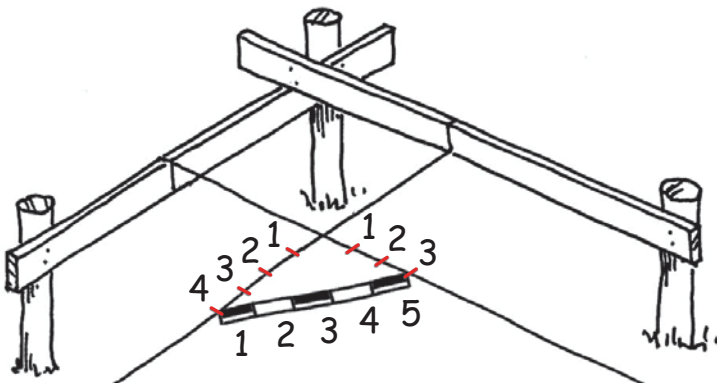

Layout

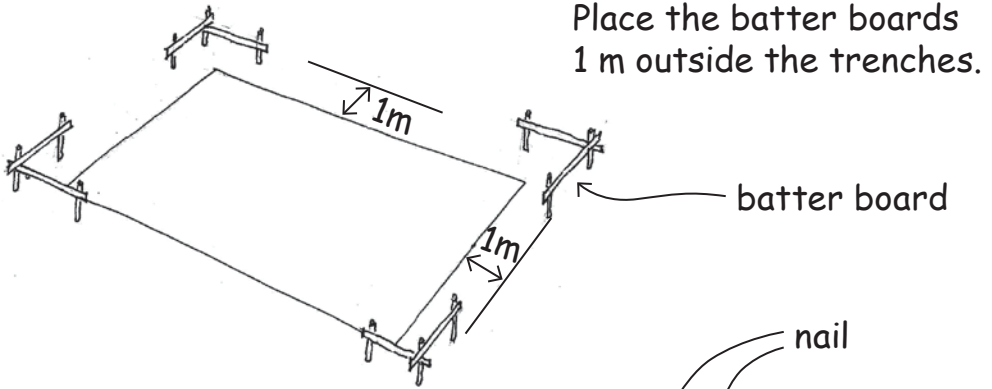

Drive in nails in order to fix the exact position of the strings.

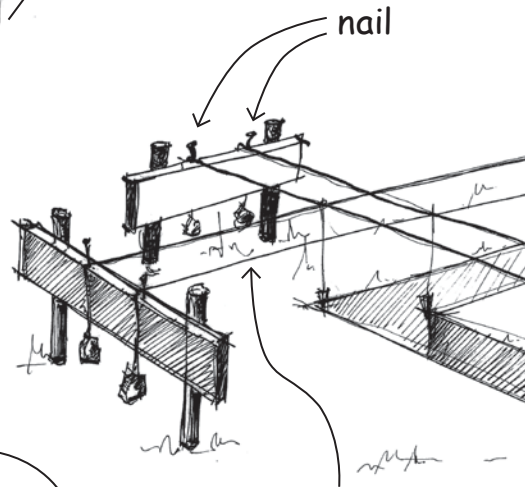

It is a rectangle if:

- each diagonal is of the same length, and if
- the opposite sides measure the same ($A=A'$, $B=B'$).

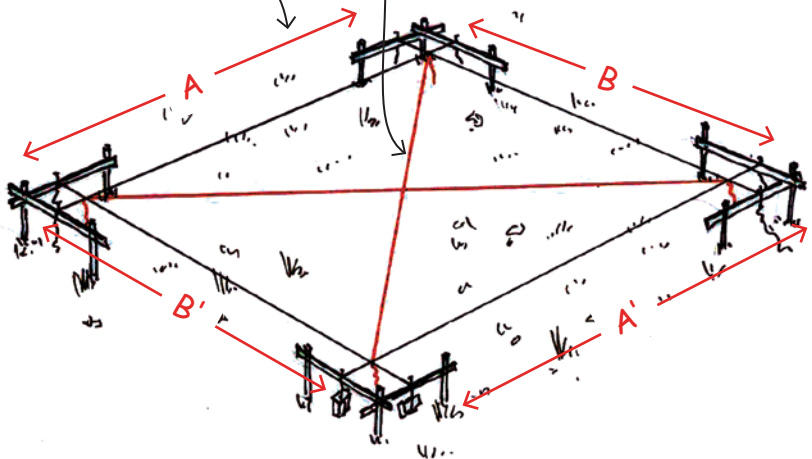

5. STONE FOUNDATION

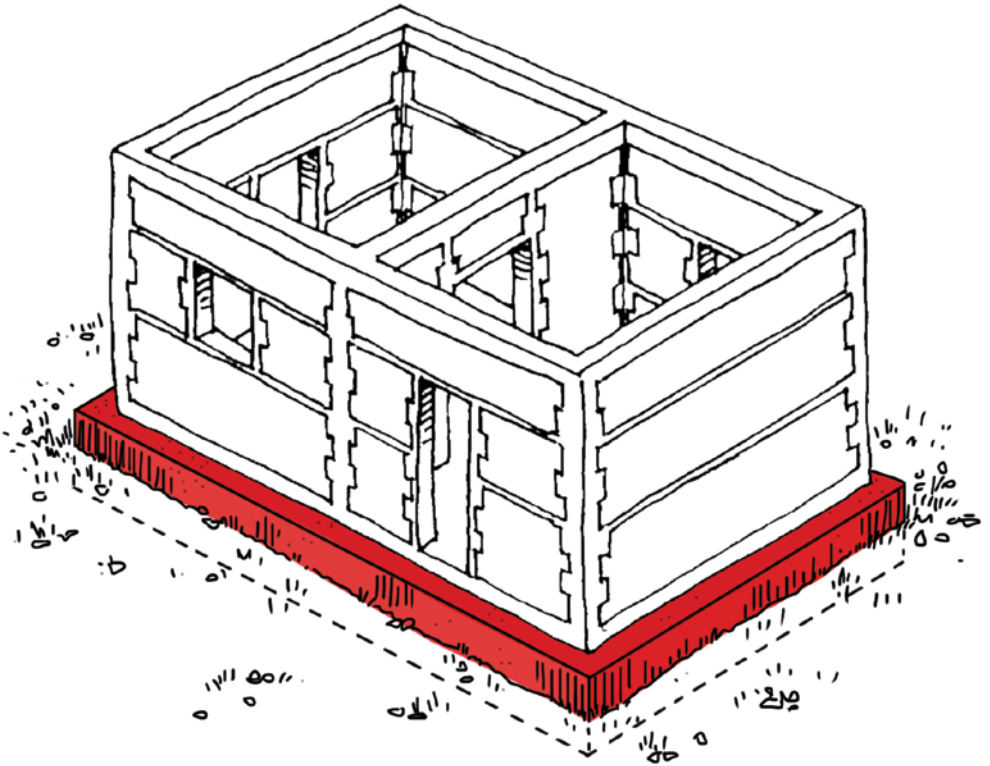

Excavation

Place the soil you have dug up at a minimum of 60 cm away from the trenches, to avoid its falling back into the excavation.

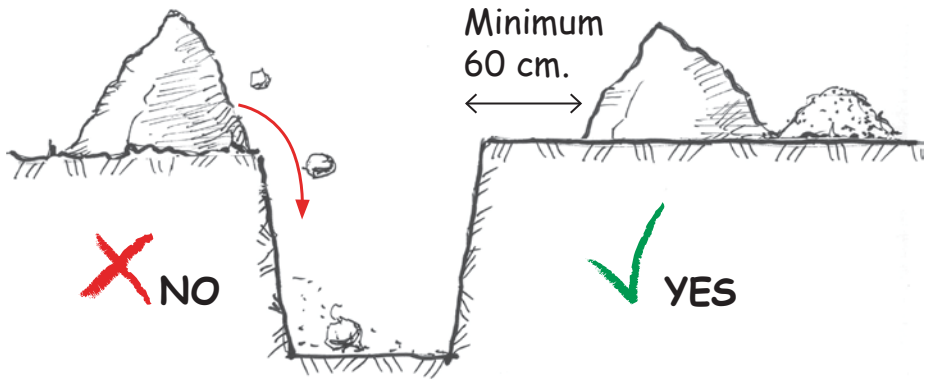

WARNING: dig until you reach firm soil and then build the foundation to the proper width.

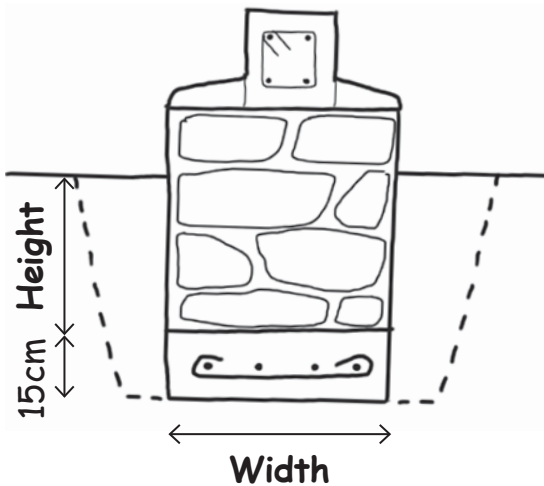

Foundation height:

- hard soil: min 30 cm
- rammed soil: min 50 cm
- soft soil: min 80 cm

Foundation width:

- hard soil: 40 cm
- rammed soil: 60 cm
- soft soil: 70 cm

Foundation dimensions

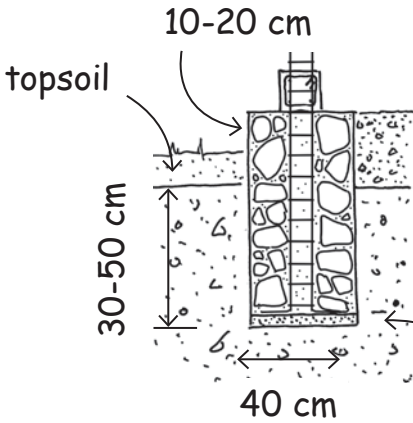

Hard soil

height: 30-50 cm
width: 40 cm

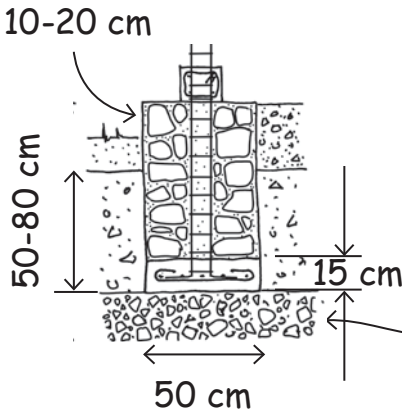

Rammed soil

height: 50-80 cm
width: 50 cm
strip footing: 50 cm

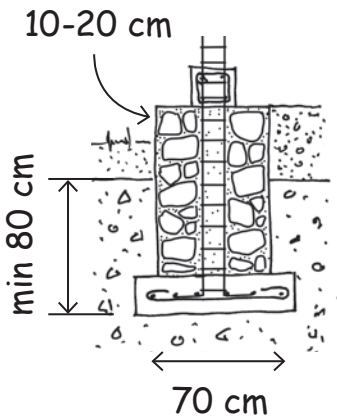

Soft soil

height: min 80 cm
width: 50 cm
strip footing: 70 cm

Warning!
Height above the ground:
maximum 20 cm

Special foundations

If the part above ground is higher than 20 cm, then the foundation acts as a retaining wall.
Do not exceed 40 cm above the ground.

The external face of the foundation wall must be inclined.

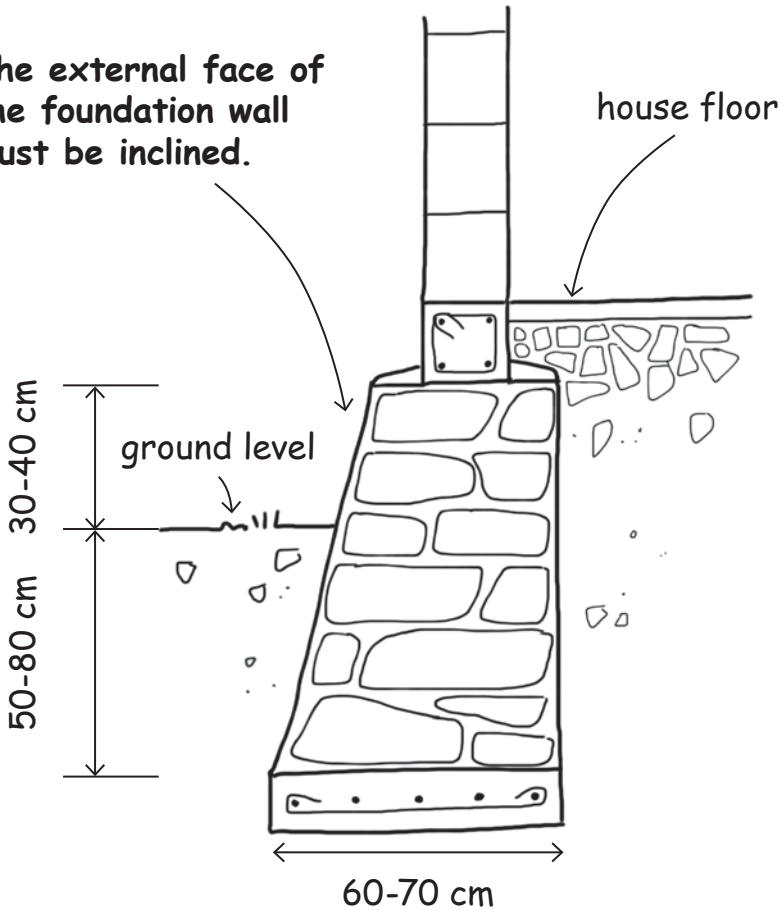

Foundation height:

rammed soil: min 50 cm
soft soil: min 80 cm

Foundation width:

rammed soil: min 60 cm
soft soil: min 70 cm

Avoid building in a flood-prone area!

Stepped foundations

If you build on a slope, the foundation must be stepped, keeping the bottom of the trench always horizontal.

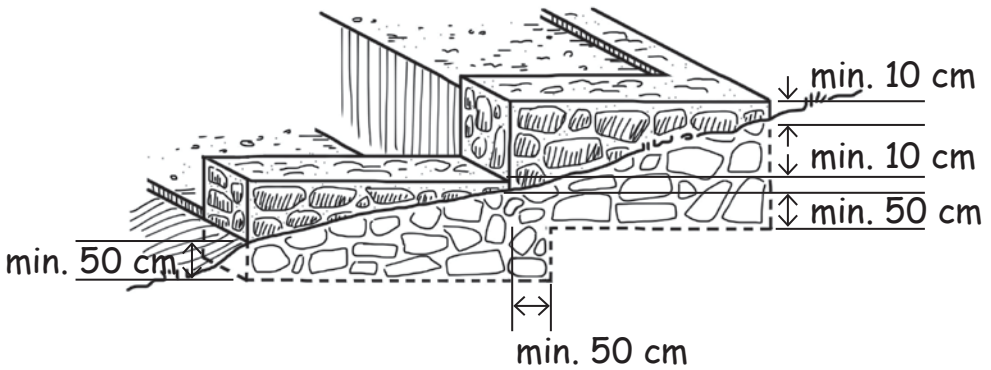
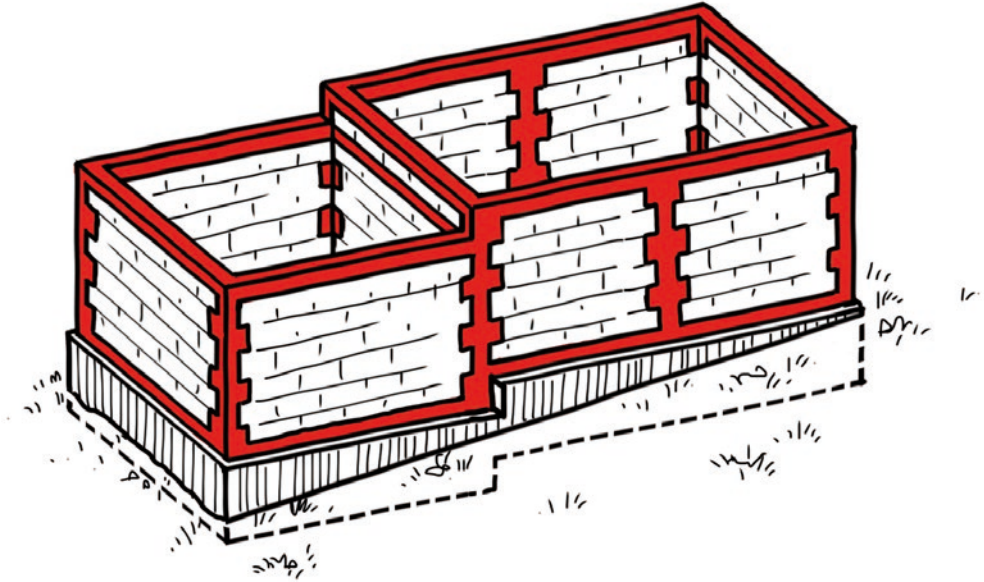

Avoid building parallel to the slope!

Stone masonry construction

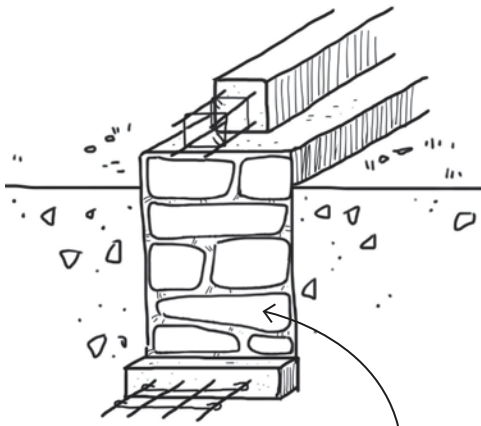

Place all the stones in a horizontal position.



YES

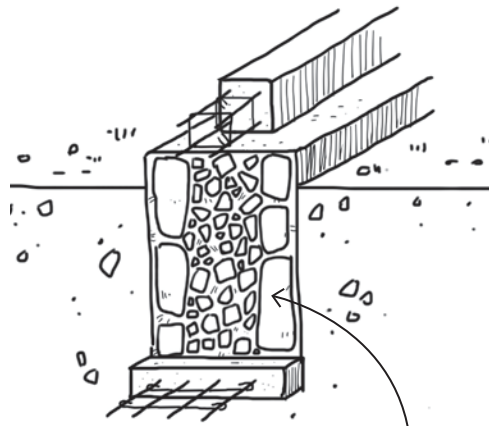

Do not place the stones vertically.



NO

Place through-stones:

Horizontally: at least every 1 m

Vertically: at least every 50 cm

Place through-stones

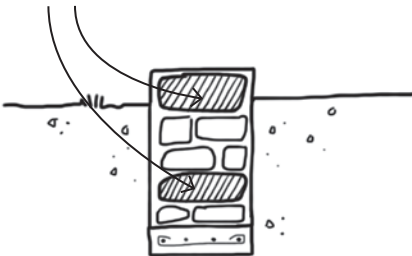

(view in section)

Place through-stones



1 m 1 m

(view in plan)

Reinforced concrete strip footing

A strip footing is a must for soft soil conditions.
It is also recommended for other soil conditions.

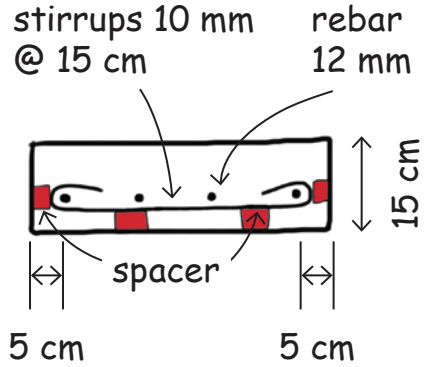
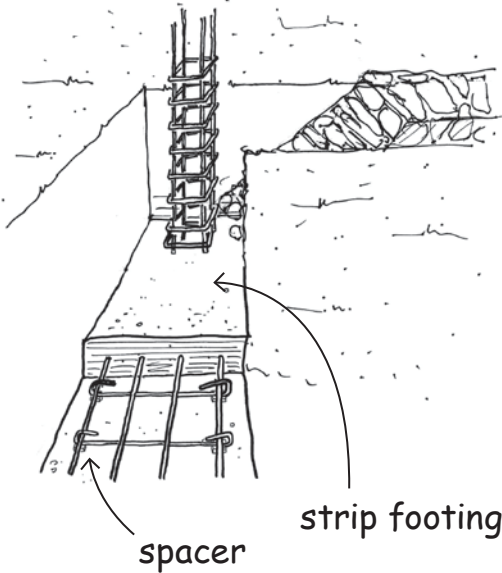

Strip footing:
Width 40 cm = 4 rebars
Width 50 cm = 4 rebars
Width 70 cm = 5 rebars

Before pouring the concrete, make sure the reinforcement is perfectly vertical.

Leave a space around the reinforcement for the concrete.

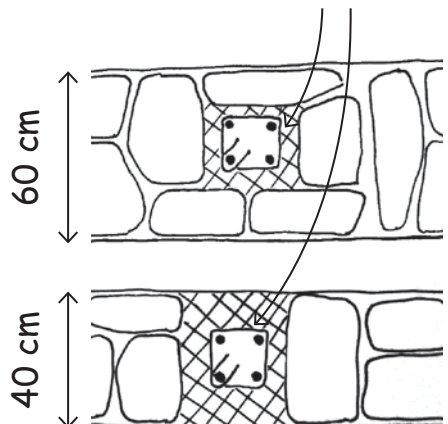
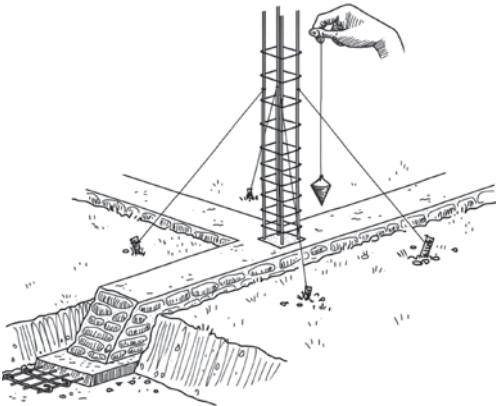

Curing and ground floor

Cure the foundation walls.
Wet every day for the three first days.

Always interrupt foundation work on a sloped line.



Build a 'drainage pad' under the floor to block ascending humidity.

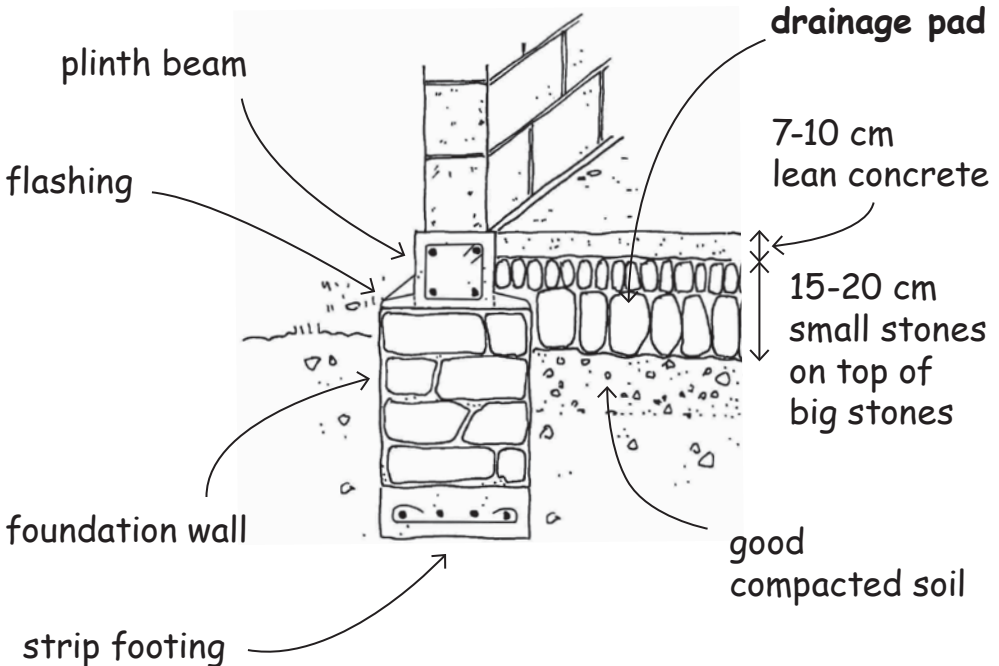

Placing sewage pipes

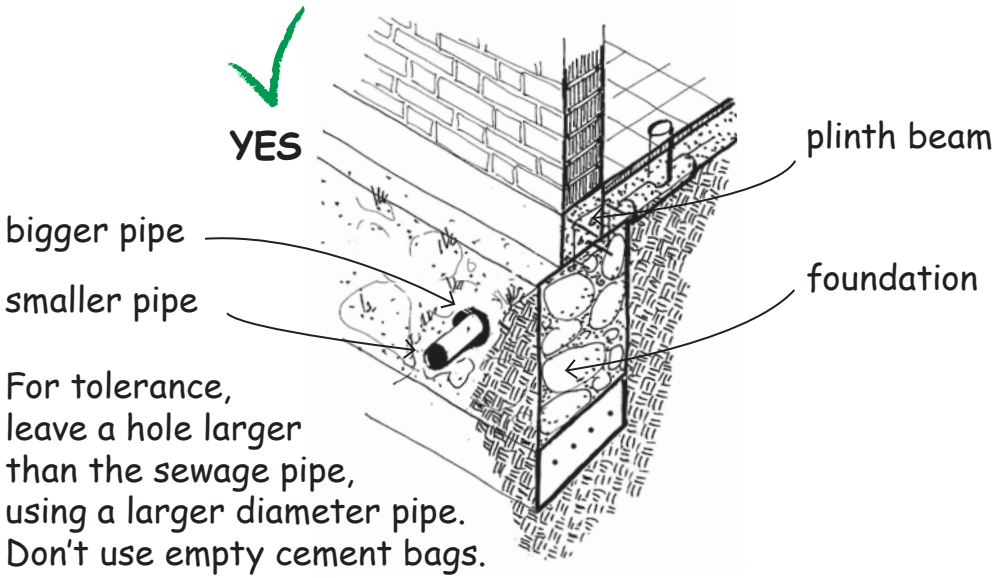

The pipe must go through the foundation, under the plinth beam.

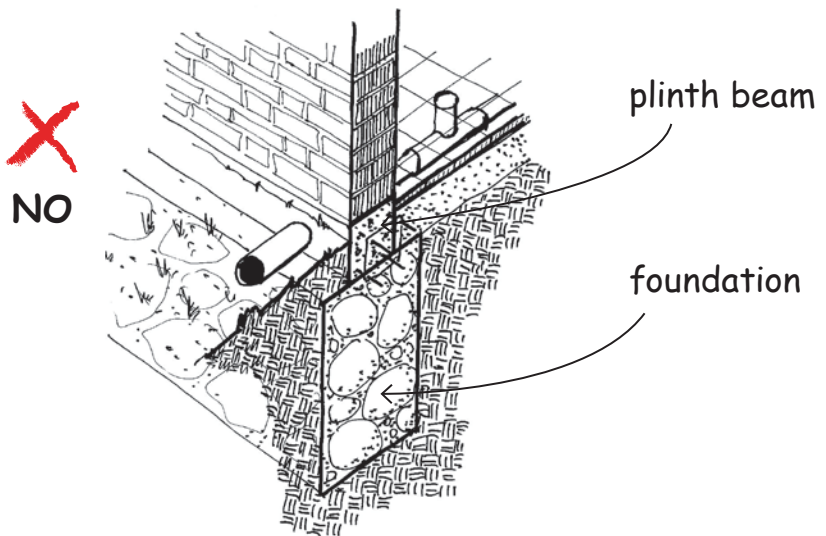

6. REINFORCED CONCRETE TIES

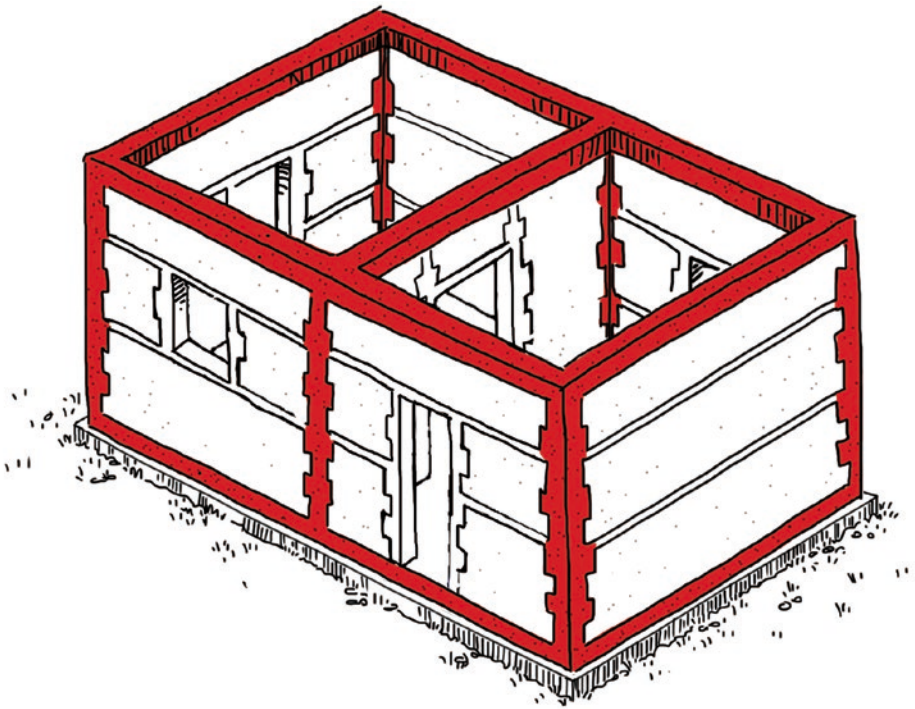

Types of steel rebars

Use ribbed steel for all rebars.

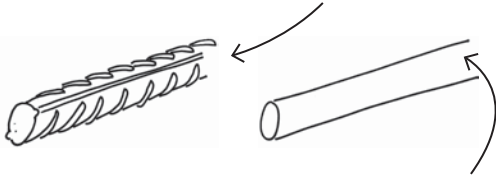

Smooth bars may only be used for stirrups.



Do not use second-hand rebars.

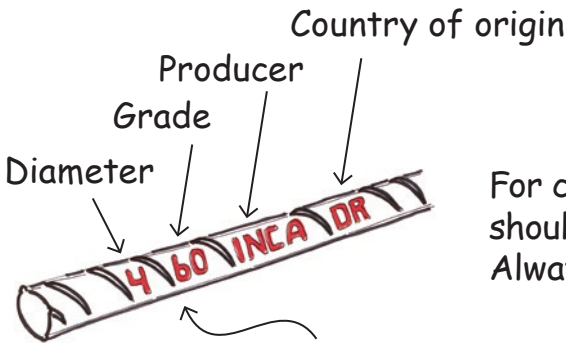

For confined masonry **Grade 60** should be used.
Always use **standard rebars**.

Strength indication are written on the rebar.

Rebars diameters (imperial and metric):

imperial	inch	metric
#4	1/2 in.	12 mm
#3	3/8 in.	10 mm
-	1/3 in.	8 mm
#2	1/4 in.	6 mm

rebars:
min \varnothing 10 mm
better \varnothing 12 mm

stirrups:
min \varnothing 6 mm
better \varnothing 8 mm

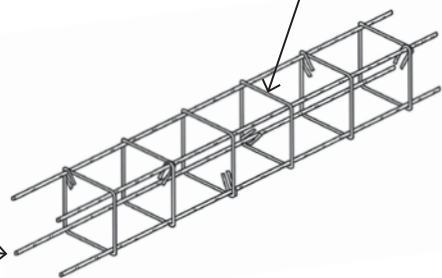

Rebar dimensions for vertical and horizontal ties

Stirrups

Bend stirrup ends at 45°.

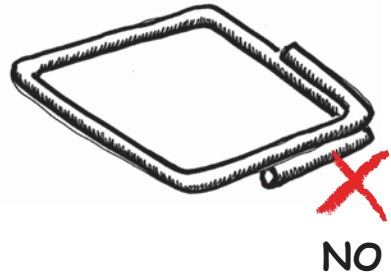
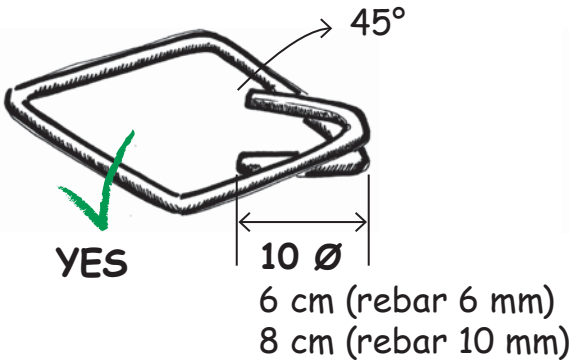

If stirrups are not bent at 45°, they will open during an earthquake.

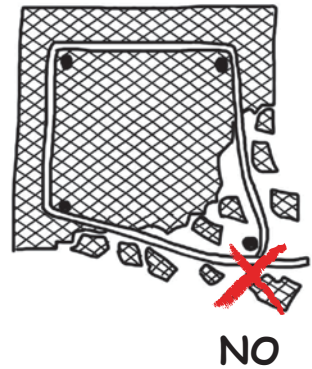
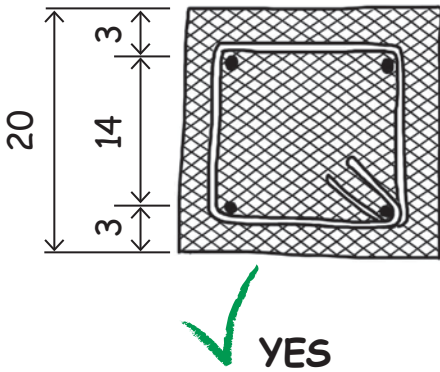

Possible stirrup types:

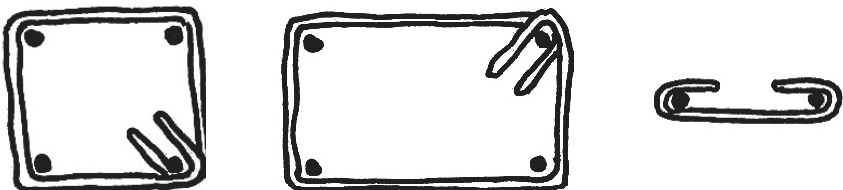

Alternate stirrup positions

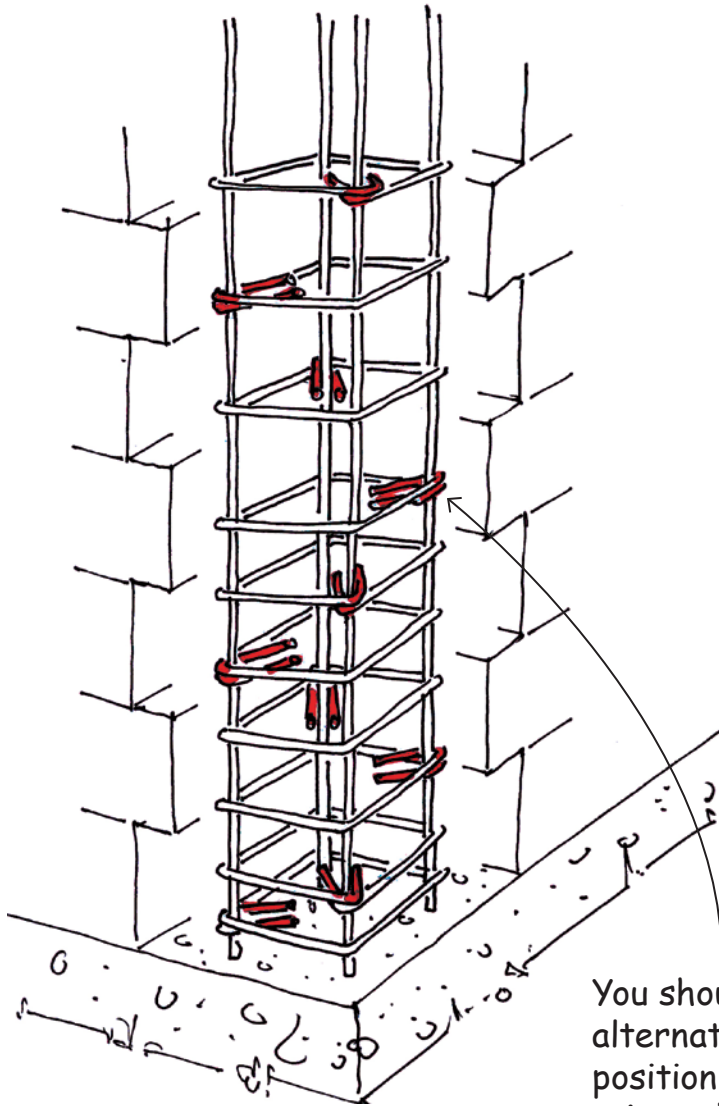

You should alternate position of stirrup hooks.

Stirrup spacing

Rules for 8 mm stirrup spacing:

1. At the top and bottom of each tie-column and ends of tie-beams place the **first stirrup at 5 cm spacing**, then place stirrups at **10 cm spacing** over a length of **$H/6$** (better 60cm).
2. Place stirrups at **20 cm spacing** elsewhere.

When using 6 mm stirrups: place them at 15 cm instead of 20 cm, and 7.5 cm instead of 10 cm.

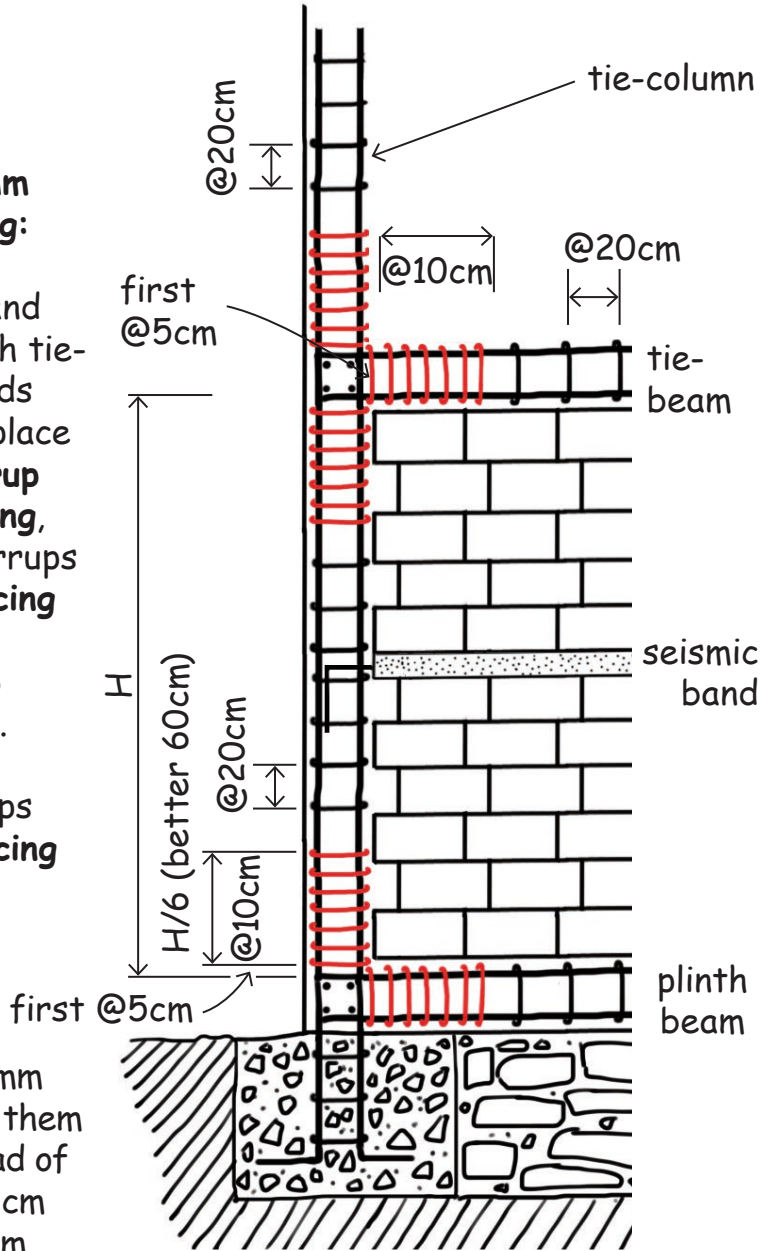

Lap length

The concrete keeps the rebars together like tight fists: the more fists we have (longer overlap) the stronger the connection.

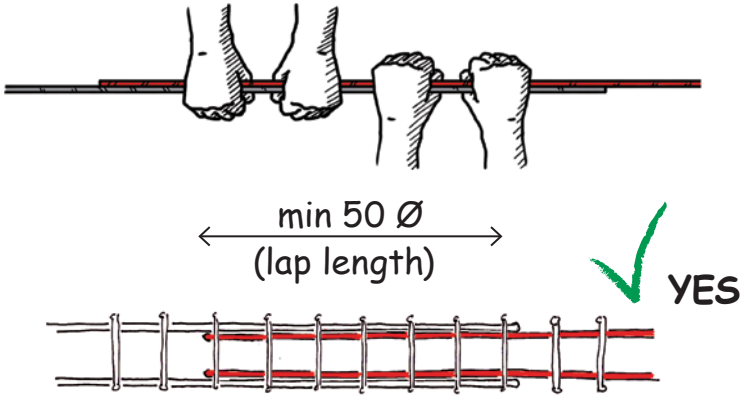

Tie wires only hold the rebars in place. They don't add strength to the connections! !

Lap length:
(overlapping)
 $50 \times \varnothing$
(50 times the diameter)

for 10 mm rebar = 50 cm
for 12 mm rebar = 60 cm

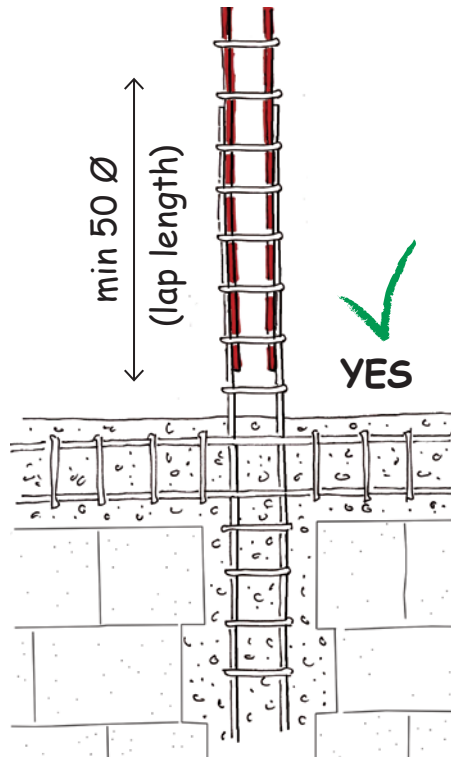

Tie-beam: T-connection

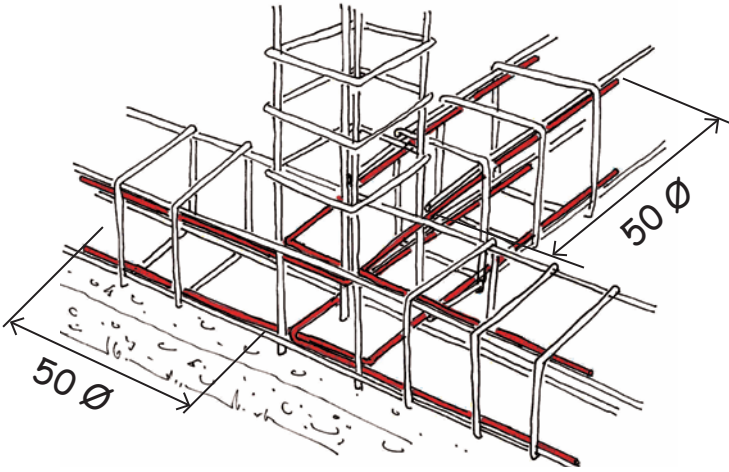

Always: extend hooked bars from the inside to the outside.

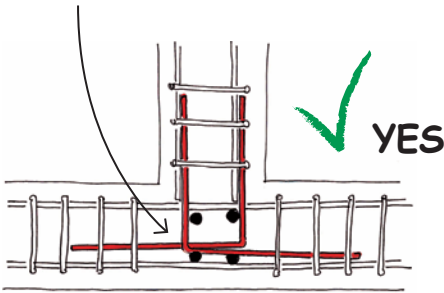

Lap length:
 (overlapping)
 $50 \times \varnothing$
 (50 times the diameter)

for 10 mm rebar = 50 cm
 for 12 mm rebar = 60 cm

Connection with straight bars.

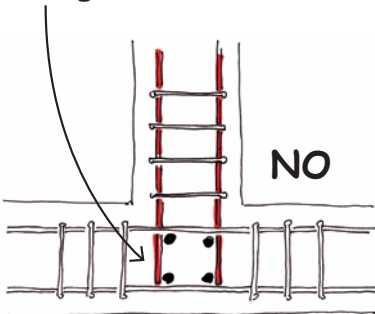

Connection around the inner corner.

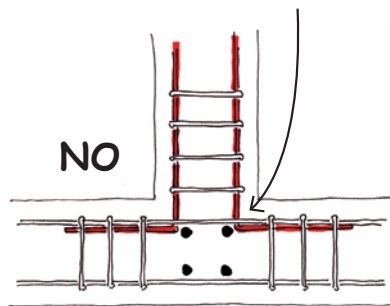

Tie-beam: L-connection

Rebars must cross like the fingers of a hand.

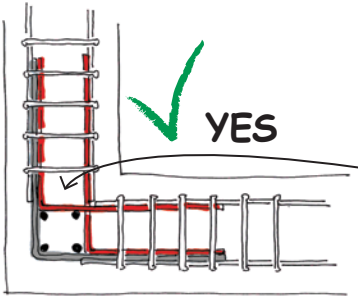
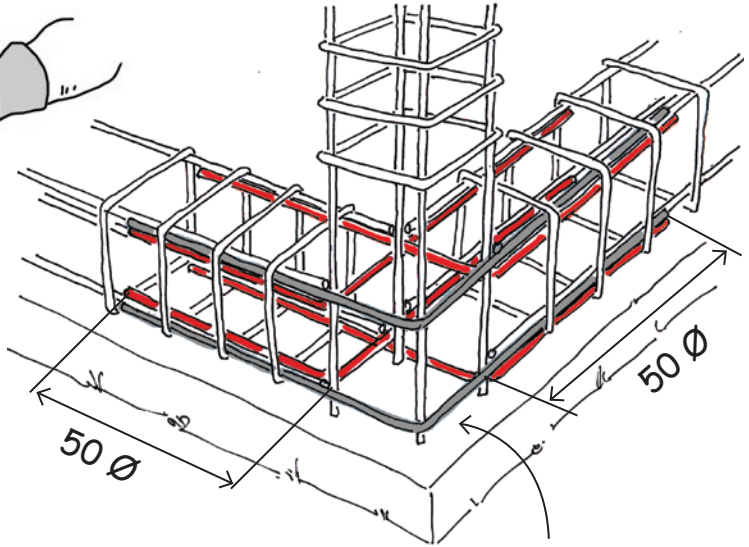

Extend hooked bars from the inside to the outside.

Put an additional rebar around the outer corner.

Connection with straight bars.

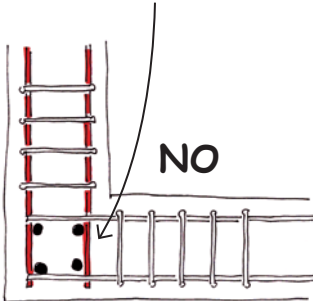

Hooked bars from inside to inside.

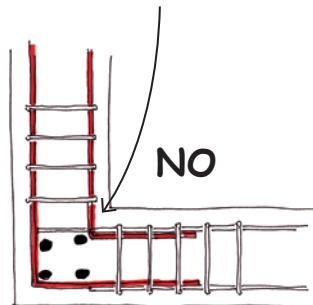

Tie-beam to tie-column connection

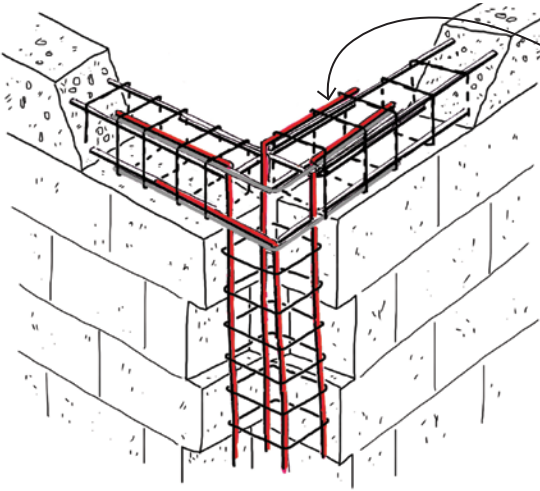

At the top of the wall bend the vertical rebar into the tie-beam.

One-storey building

If you plan to build an upper floor (1st floor) in the future, leave 90 cm in order to create little columns which can be used to fix guard rails.

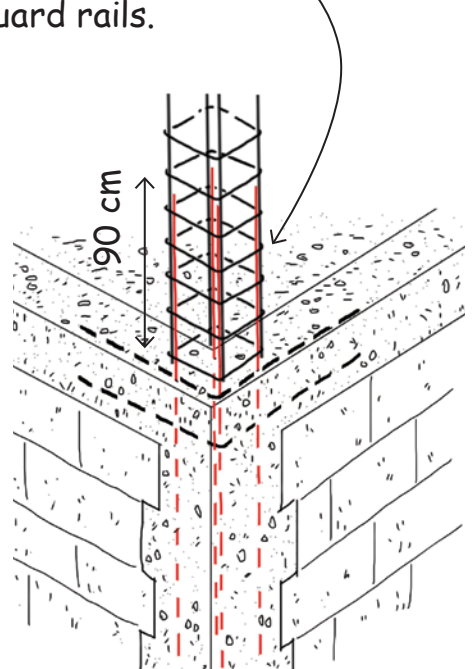
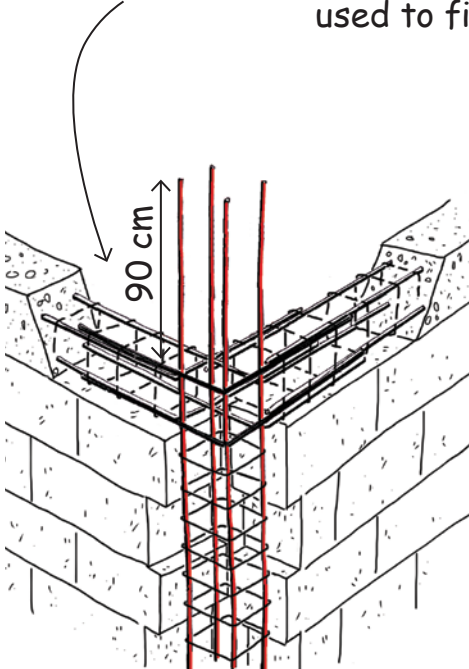

Two-storey building

Protection of rebar ends

Protect rebars with lean concrete.

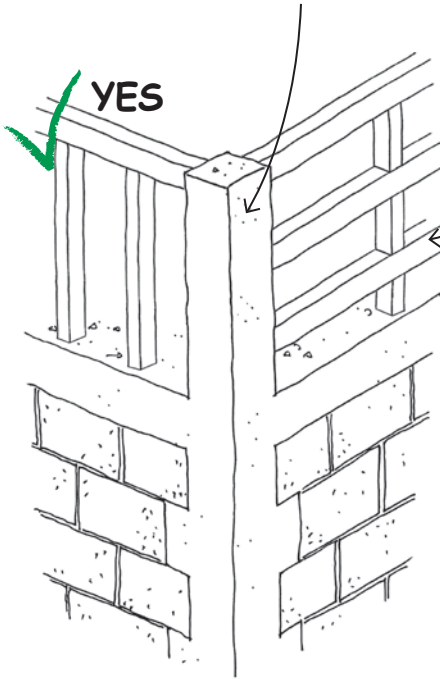

Use the little columns to fix guard rails.

Exposed rebars will rust and cannot be reused.

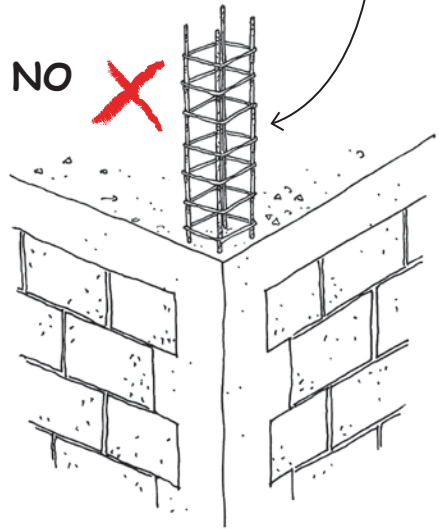

protected rebar ends

YES

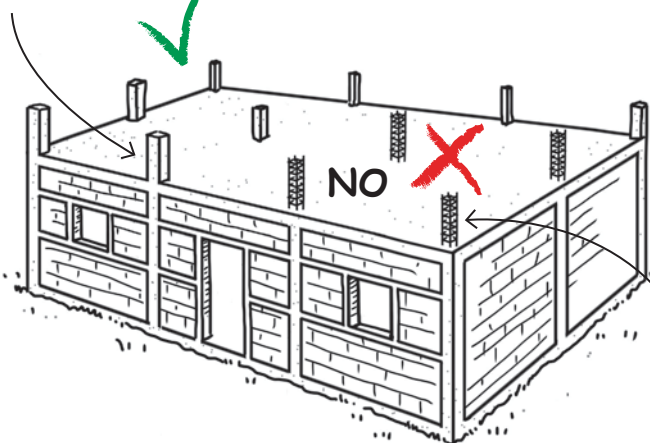

exposed rebar ends

7. FORMWORK

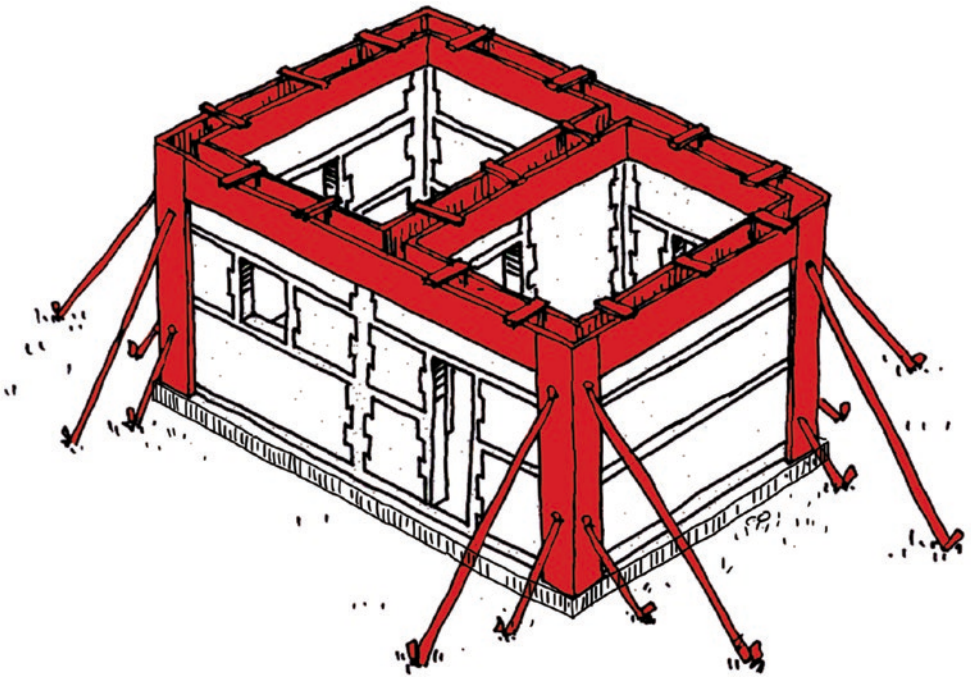

Formwork for ties

Block walls:

20cm wall thickness:
place formwork boards
on both sides.

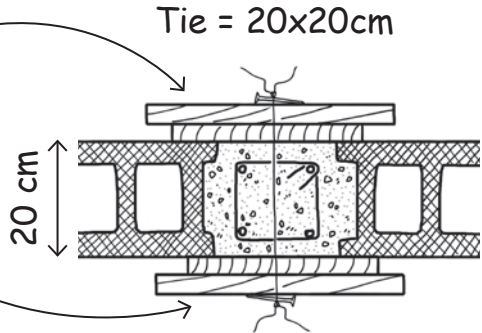

Tie = 20x20cm

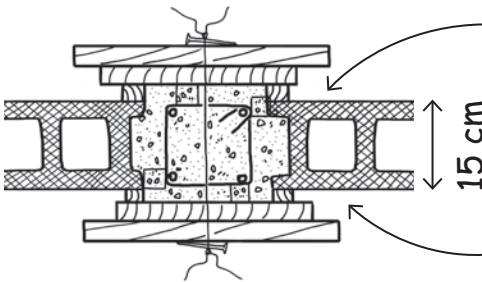

15cm wall thickness:
Place a 1 inch board
under the formwork
board.

Brick walls:

15-24cm wall thickness:
place formwork boards
on both sides.

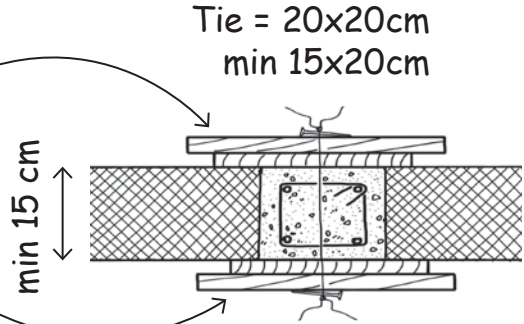

Tie = 15x20cm

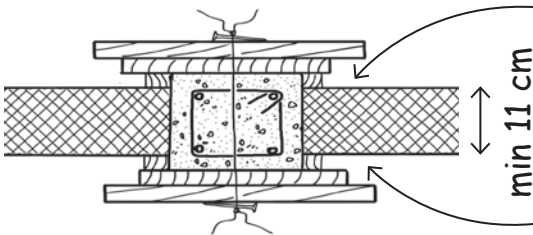

15cm wall thickness:
Place a 1 inch board
under the formwork
board.

Sizes of tie-columns and tie-beams:
20 x 20 cm recommended / 15 x 20 cm minimum

Vertical formwork

Formwork fixed with wires

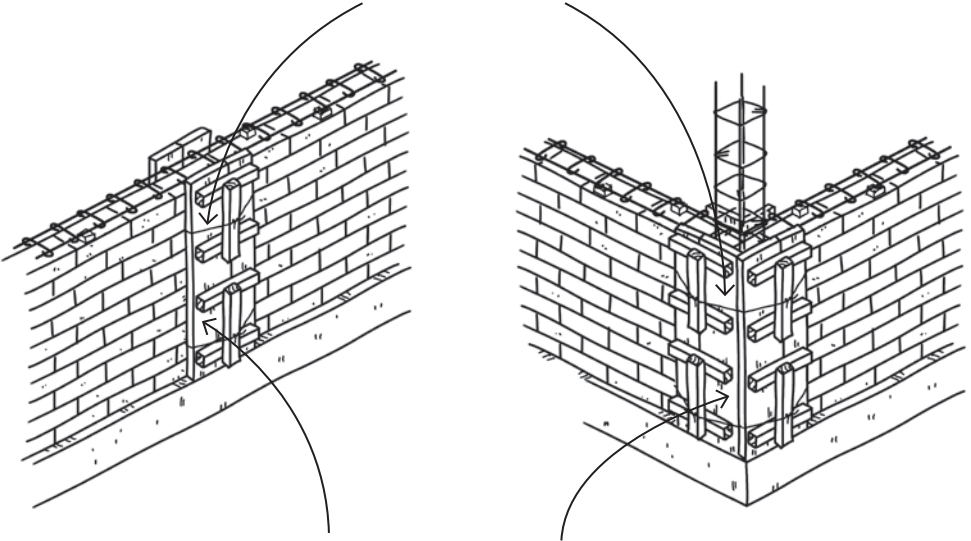

Attention: with this type of formwork wait until the masonry is solid or the wires will move the bricks.

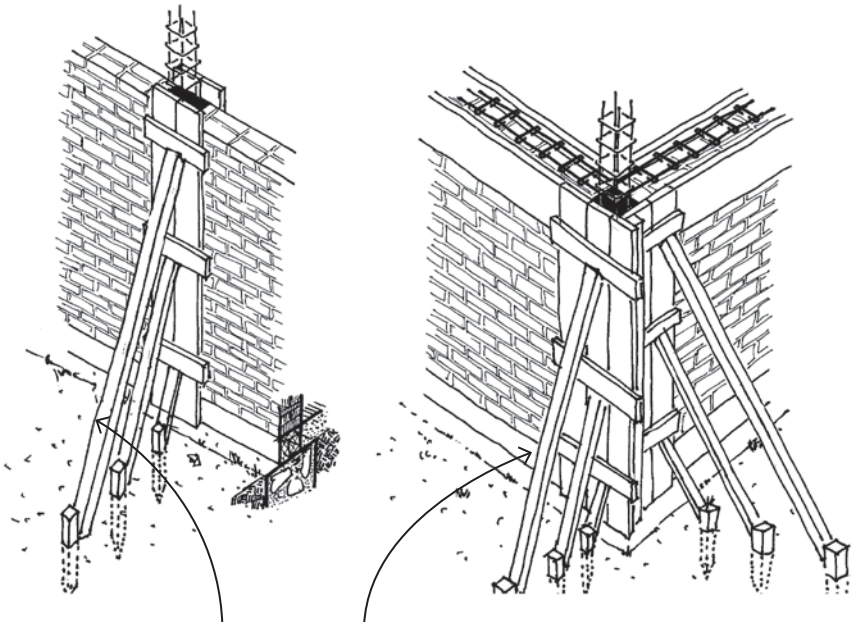

Formwork must be well braced.

Horizontal formwork

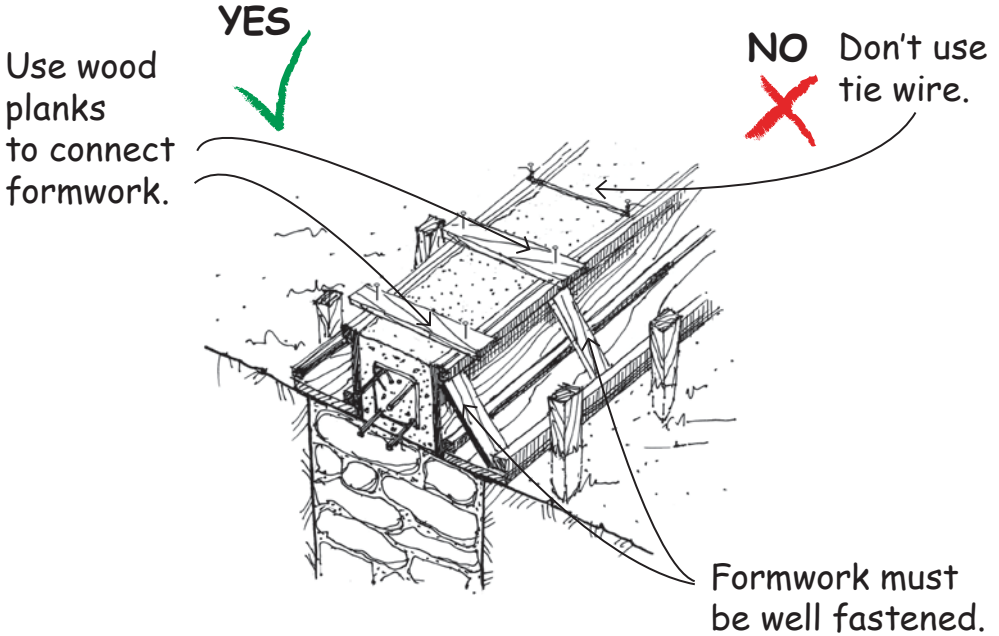

Using small planks to keep the formwork apart ensures more precision and stability than wires.

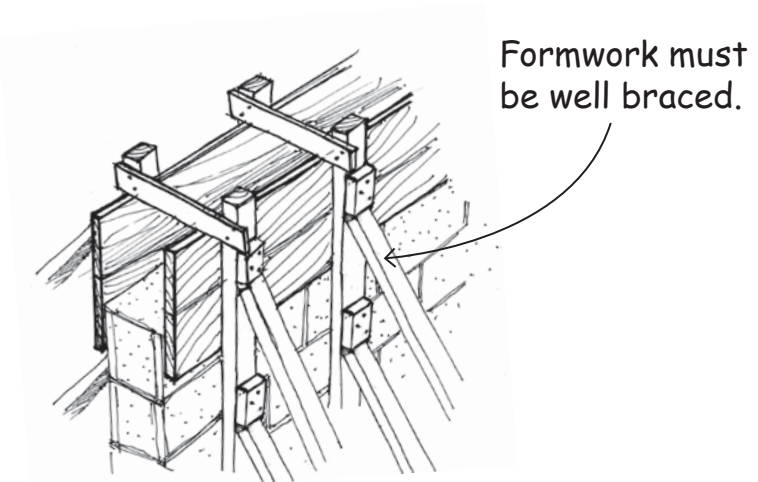

Spacers - 1

Spacers are very important: they ensure that the rebars remain in the right place and are well covered by concrete.

Don't use stones to fix the rebars, use spacers instead.

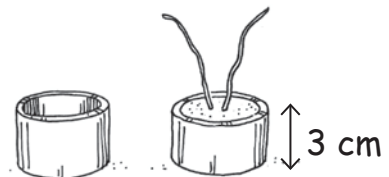
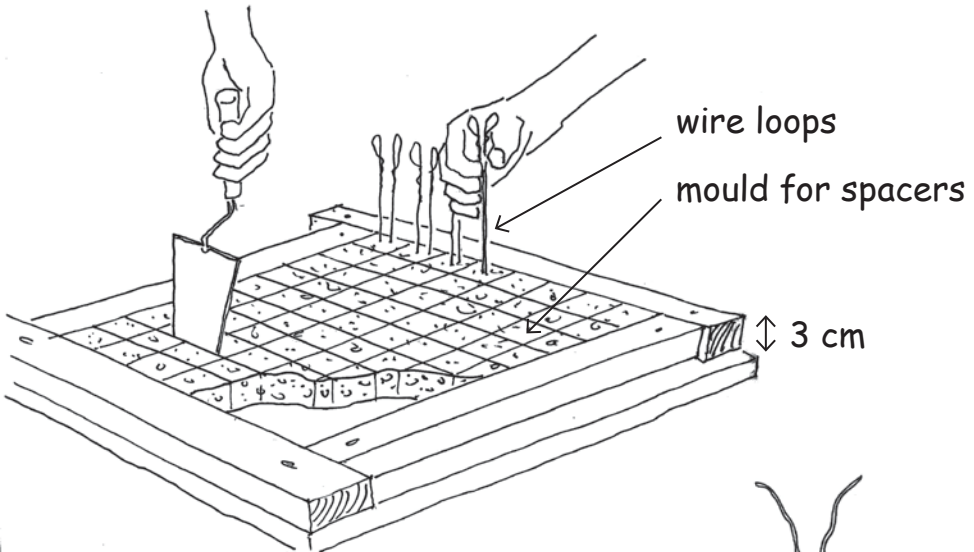
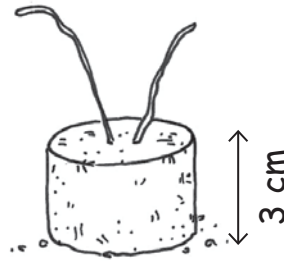
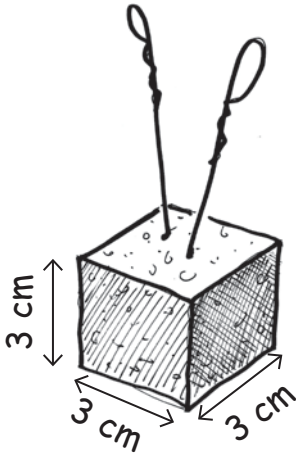

Spacers - 2

Add spacers on all sides to avoid rebars touching the formwork.

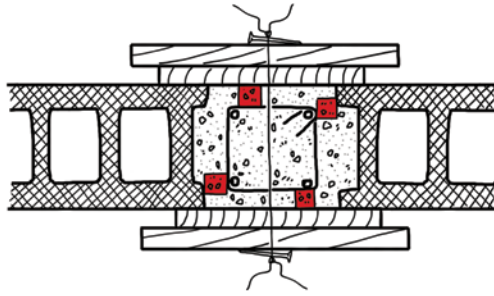

tie-column

Alternate the position of the spacers around the stirrups.

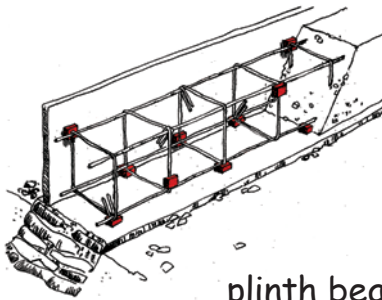

plinth beam

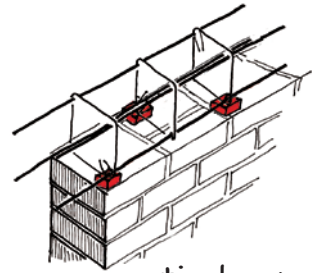

tie-beam

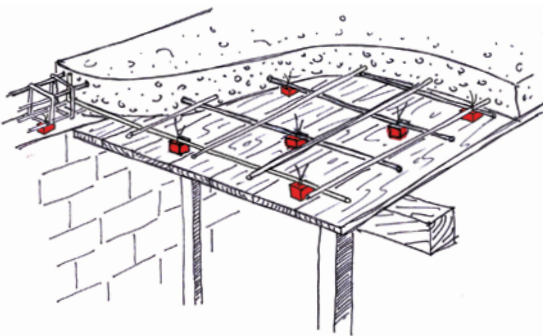

reinforced concrete slab

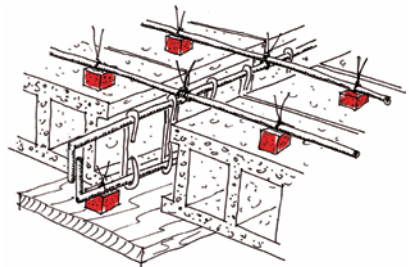

joist and pan slab

8. CONCRETE

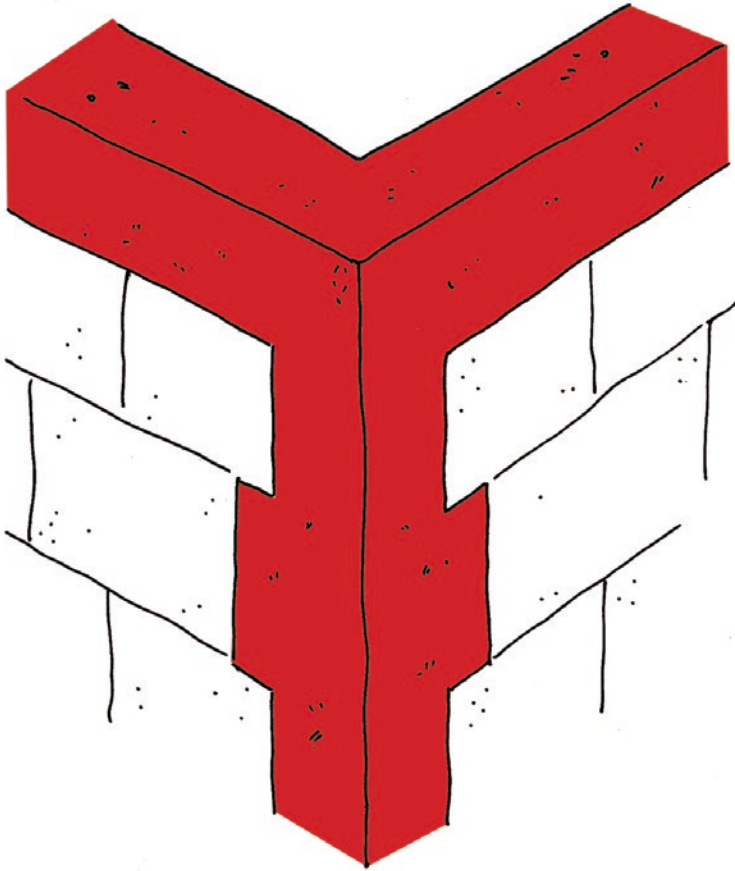

Concrete mix (1:2:3)



1 part
cement

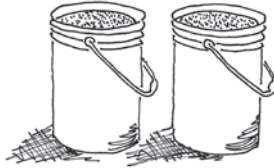

2 parts clean sand
(washed and dry)



3 parts gravel
(max. 18mm)



3/4 part clean water
(depending on the humidity
of the agregates)

Table of various concrete mixes (by volume):

	Cement	Sand	Gravel	Strength	
minimum	→ 1	2	4	180 kg/cm ²	
standard	→ 1	2	3	210 kg/cm ²	✓
ideal	→ 1.5	2	3	240 kg/cm ²	

Note:

Concrete with a strength of 210 kg/cm² corresponds more or less to 350 kg of cement per cubic meter of aggregates.

http://www.developmentbookshelf.com/doi/book/10.3362/9781780449883 - Monday, January 22, 2018 6:25:39 AM - IP Address: 193.5.216.100

Mixing concrete

Mixing the concrete by hand:



1. Make a pile with the gravel, the sand and the cement but without water.



2. Mix the pile without water and move it twice with a shovel.



3. Add the water and mix again. **Only add the water at the end.**

Mixing with a concrete mixer:



1. Add half of the water and 1 part of gravel, mix 1 minute.

2. Add the cement and the rest of the aggregates.

3. Add rest of the water slowly, mix 3-4 minutes (not more).

Always use the concrete within 90 minutes of mixing!

Concrete test

QUICK TEST:

Take a handful of concrete. If you can form a nice ball, the concrete is perfect. If the concrete leaks through your fingers, it is too wet.

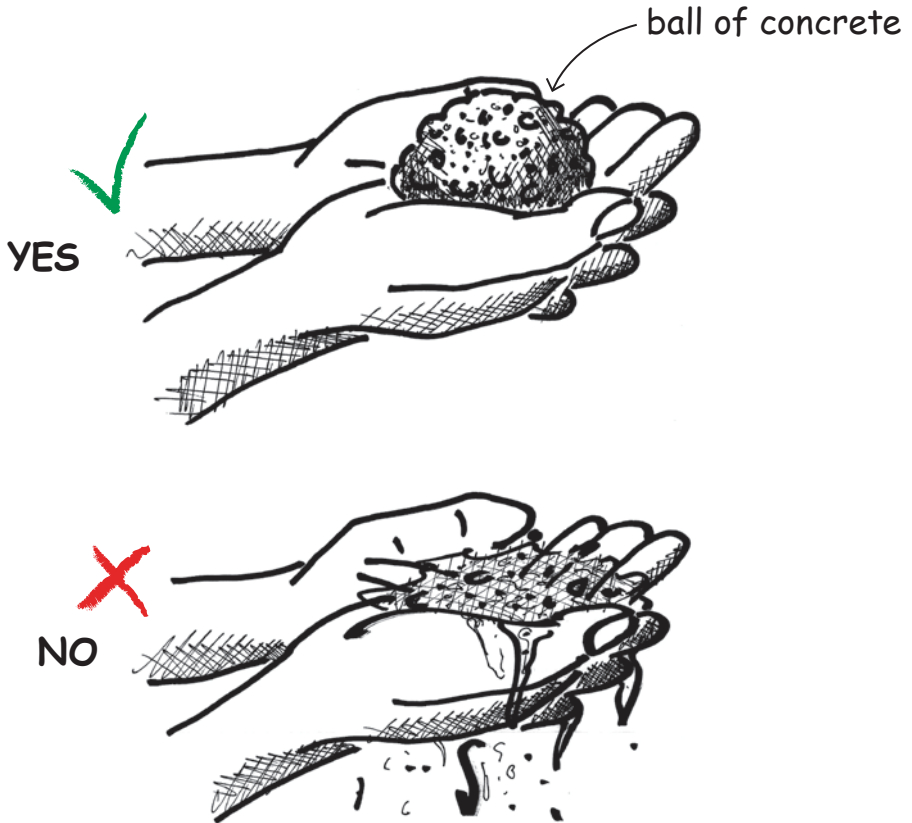

Concrete must be **used in less than 90 minutes**.
Never 'refresh' dried concrete by adding water.
Don't mix too much concrete at a time.

Slump test

SLUMP TEST PROCEDURE:

Use a standard steel cone:

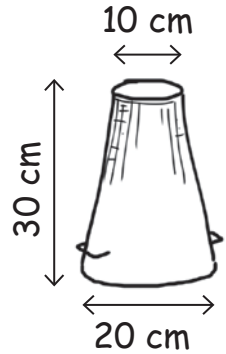

1. Fill cone in 3 equal layers.

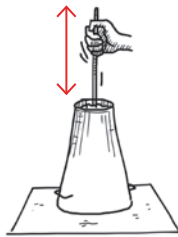

2. Tamp down each layer 25 times with a rod (rebar).



3. Lift the cone vertically and place next to the slump.

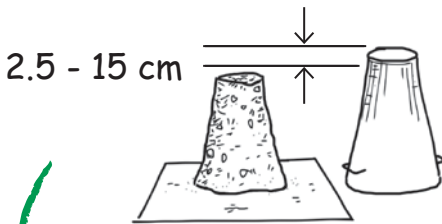

YES

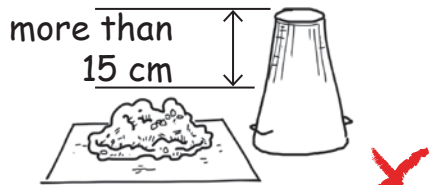

NO

Interpretation of results:

Workability	mm	Use
low	25-50	foundations with little reinforcement
medium	50-100	for compacted and vibrated concrete
high	100-150	parts with very congested reinforcements and narrow structural elements

Pouring and compacting concrete

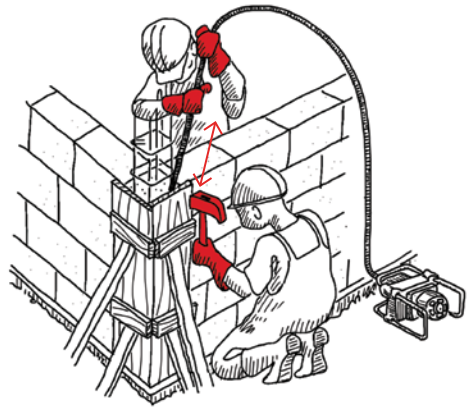
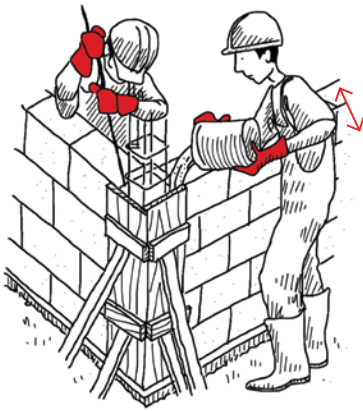

Pour the concrete in layers of 30 to 60 cm and compact well with a rod and hammer, or better, with a vibrating needle.

Never add water to make the concrete more liquid and 'flow down better'.

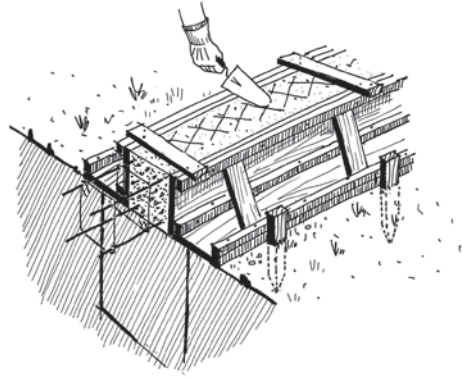
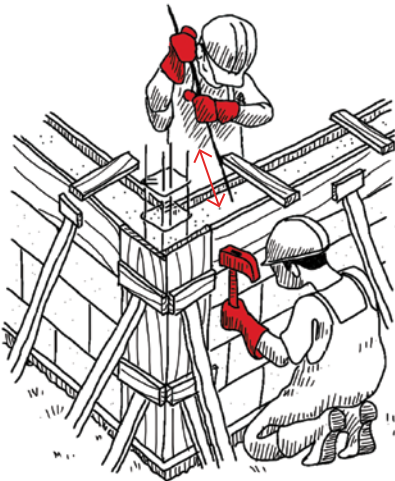

Roughen up the top surface of the plinth beam to increase bonding of the mortar for the wall.

Compacting with a vibrating needle

By compacting the concrete with a vibrator needle, trapped air will rise to the surface in the form of air bubbles.

1. Insert the vibrating needle 10 cm into the previous layer.
2. Leave the needle for not more than 5 to 15 seconds to avoid the concrete disintegrating.

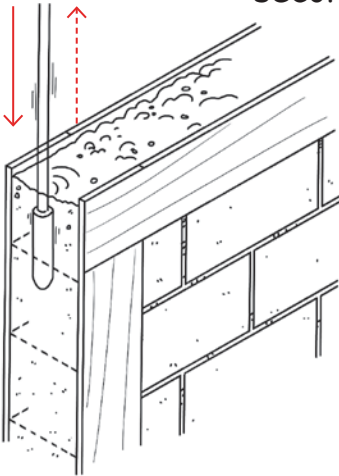

3. Lift the needle slowly (air bubbles rise at a speed of 2.5 to 7.5 cm per second).

4. Don't touch the reinforcement steel while vibrating.

5. Don't use the needle to move the concrete sideways.

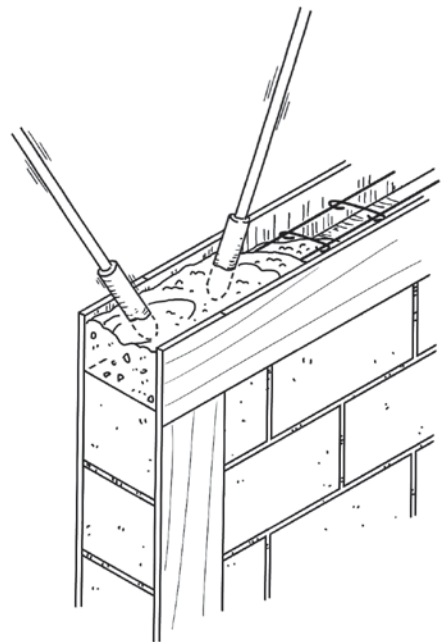

Advance at regular intervals following the action radius of the needle.

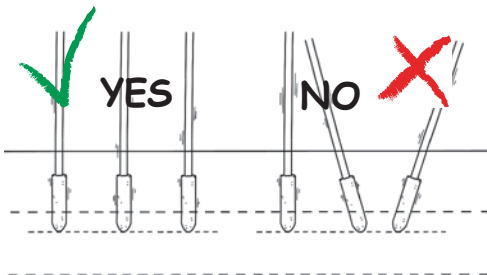

Curing the concrete elements

Concrete needs water to harden.

After placing concrete, cure the concrete by wetting the formwork three times a day for three days. Remove formwork only after three days.



After formwork is removed, cure the concrete for seven days, and cover it with plastic sheets.

Ensure good-quality concrete

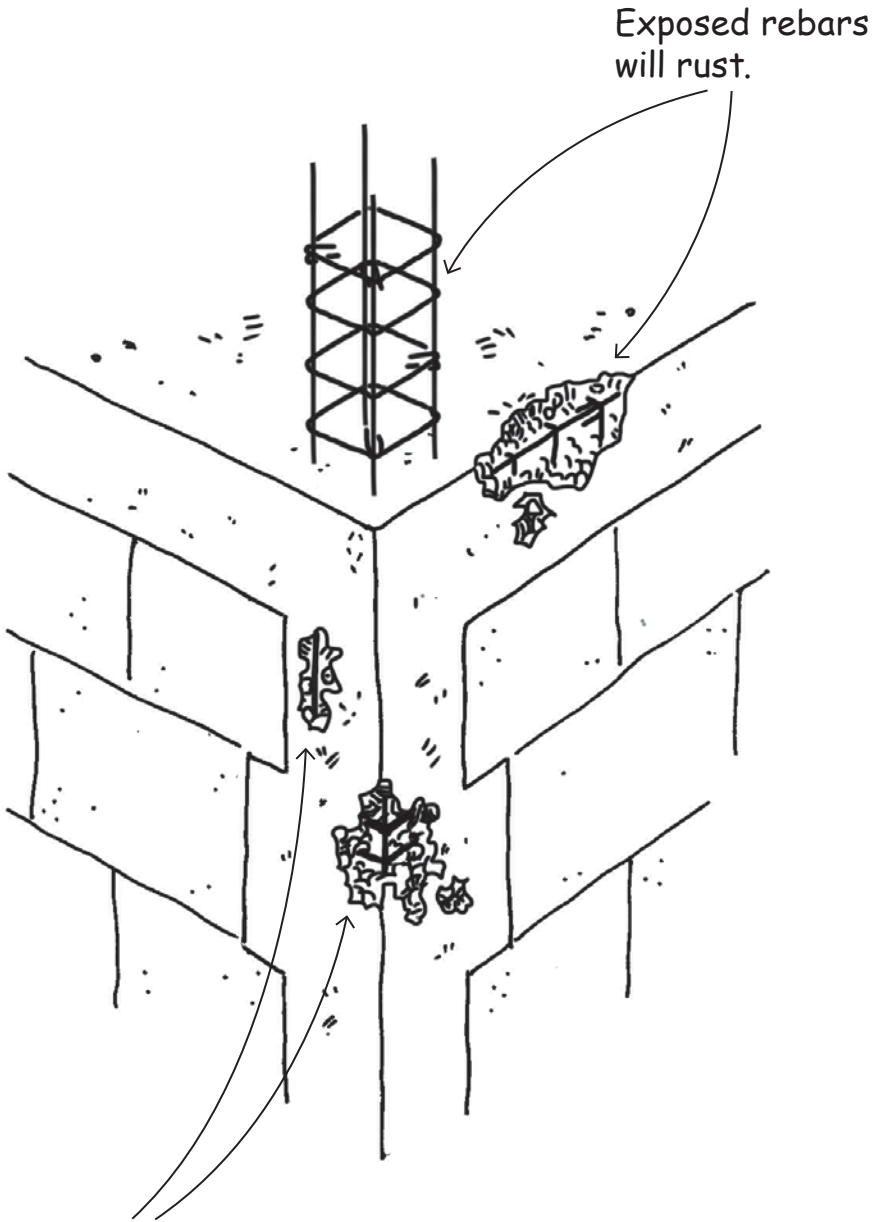

Poor compaction:
the concrete is weakened.

9. BRICKS AND BLOCKS

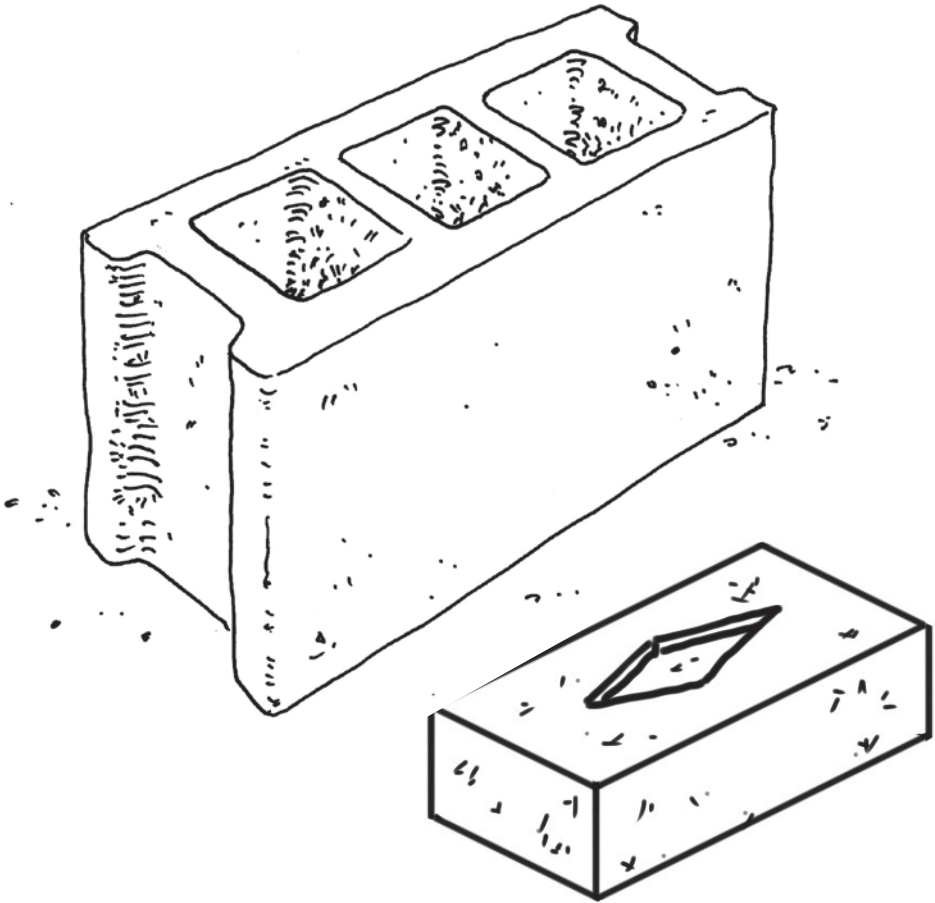

Which clay bricks to use

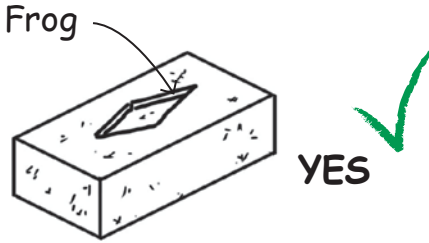

Best brick:
solid burnt-clay brick
with frogs.

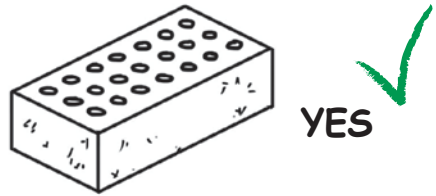

Good brick:
vertical holes less than
50% of surface area.

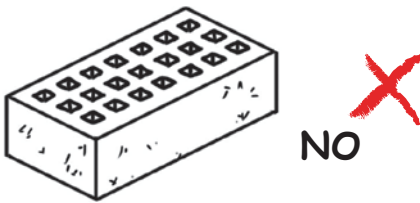

Bad brick:
vertical holes more than
50% of surface area.

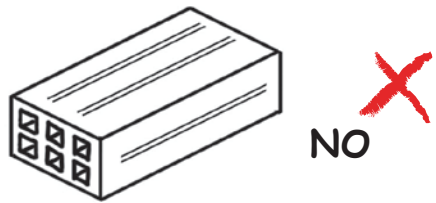

Bad brick:
with horizontal holes
(cannot carry weight).

Solid bricks are better than multiperforated ones.

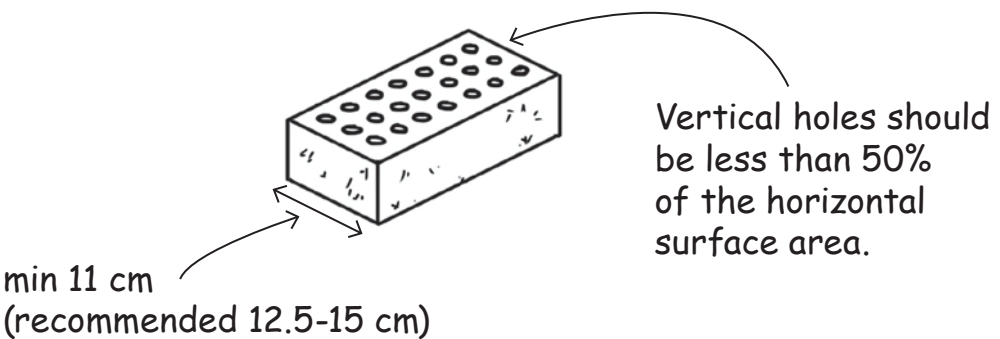

Note: we recommend using 10MPa bricks.

Brick test

Visual test:

1. regular in form
2. uniform colour
3. not warped
4. no visible flaws or lumps

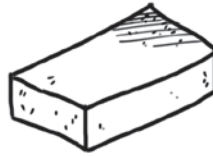

NO 



NO 



NO 



NO 

Physical test:

1. Bricks cannot be easily scratched by a knife.



2. Resists the '3 point test':
Person stands on a brick
spanning two other bricks.



3. Bricks must give a ringing
sound when struck
against each other.

Which concrete blocks to use

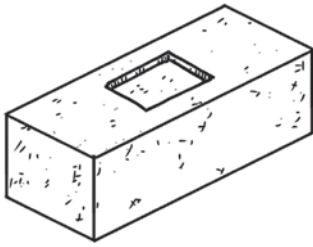

YES

Best block:
15-20 cm thick,
solid block.

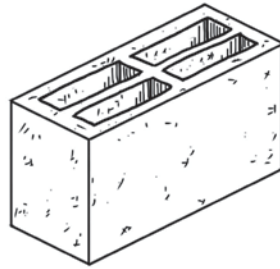

YES

Best block:
15-20 cm thick,
with 4 holes.

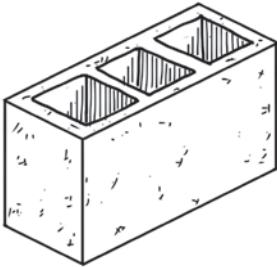

YES

Satisfactory block:
18-20 cm thick,
with 3 holes.

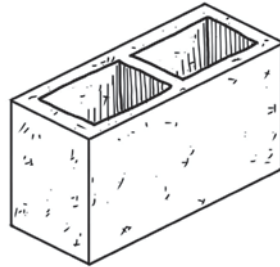

YES

Only if excellent quality:
20 cm thick,
with 2 holes.

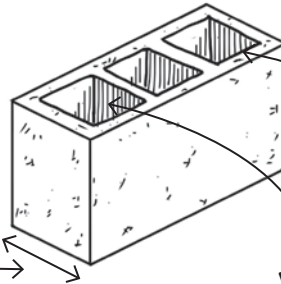

min 15 cm thick
recommended 20 cm.

web thickness
min 25mm

voids less than 50%

Note: we recommend using 10MPa blocks.

Block test

Test blocks before buying them

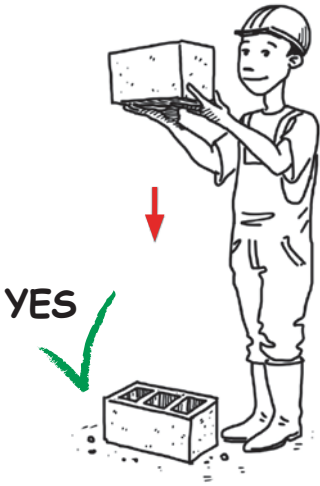

Drop five blocks from 1.5 m height on a hard surface (concrete surface).

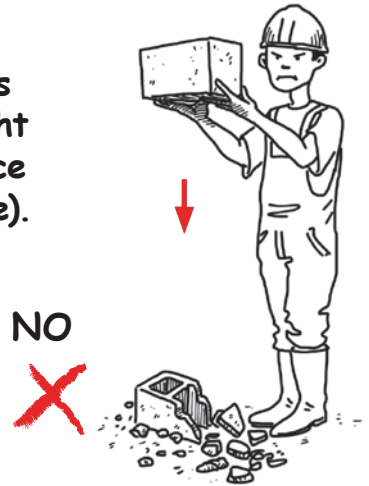

Acceptable quality:
(less than one broken)

Bad quality: don't buy
(if more than one broken)

Check if blocks were cured in the shade.

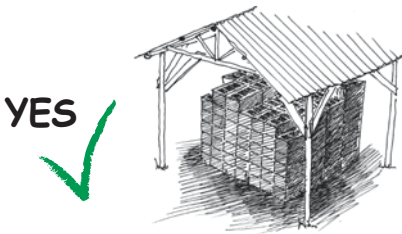

Stored in the shade: good

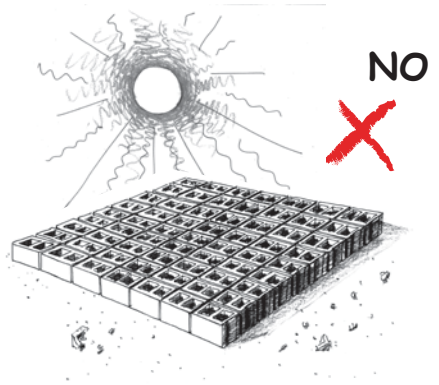

Blocks that dry in the sun: very bad

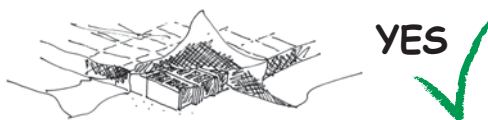

Stored under plastic sheets: good

Concrete mix for blocks (1:4:3)

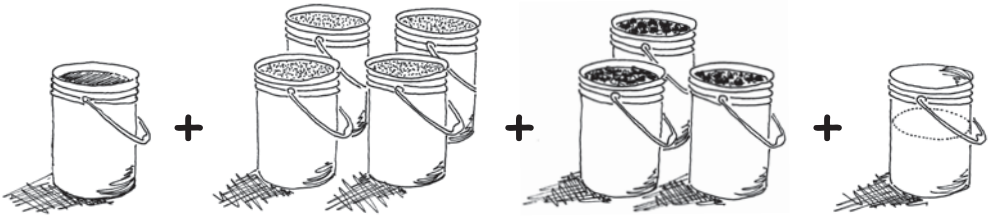

1 part
cement

4 parts
clean sand

3 parts
gravel (8-10mm)

3/4 part
clean water

Sand should be crushed, washed and dried.
Do not use marine beach sand.



1. Make a pile with the gravel, the sand and the cement but without water.



2. Mix the pile without water and move it twice with a shovel.



3. Add water and mix again.

**Add water
only at the end.**

Making the blocks

Wait eight days before using the blocks.

If possible use a vibrating machine

Fill the molds with the mixture.

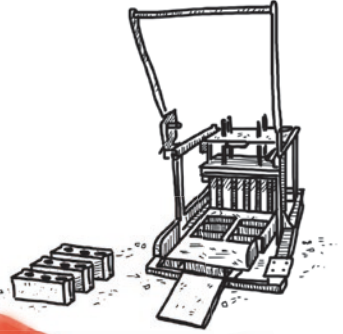
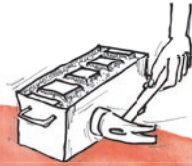

To compact the concrete, hit the mold with a shovel and a hammer.

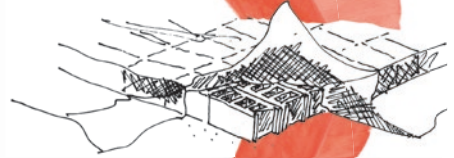

Cover the blocks with plastic sheets immediately.

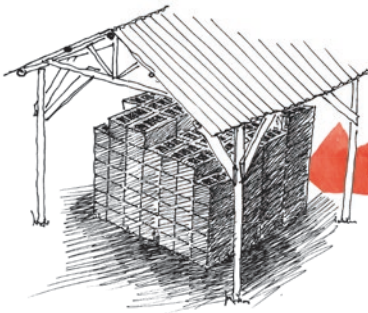

Store the blocks in the shade.



Cure the blocks three times a day for **minimum seven days** and cover with plastic sheets.

10. MASONRY WALLS

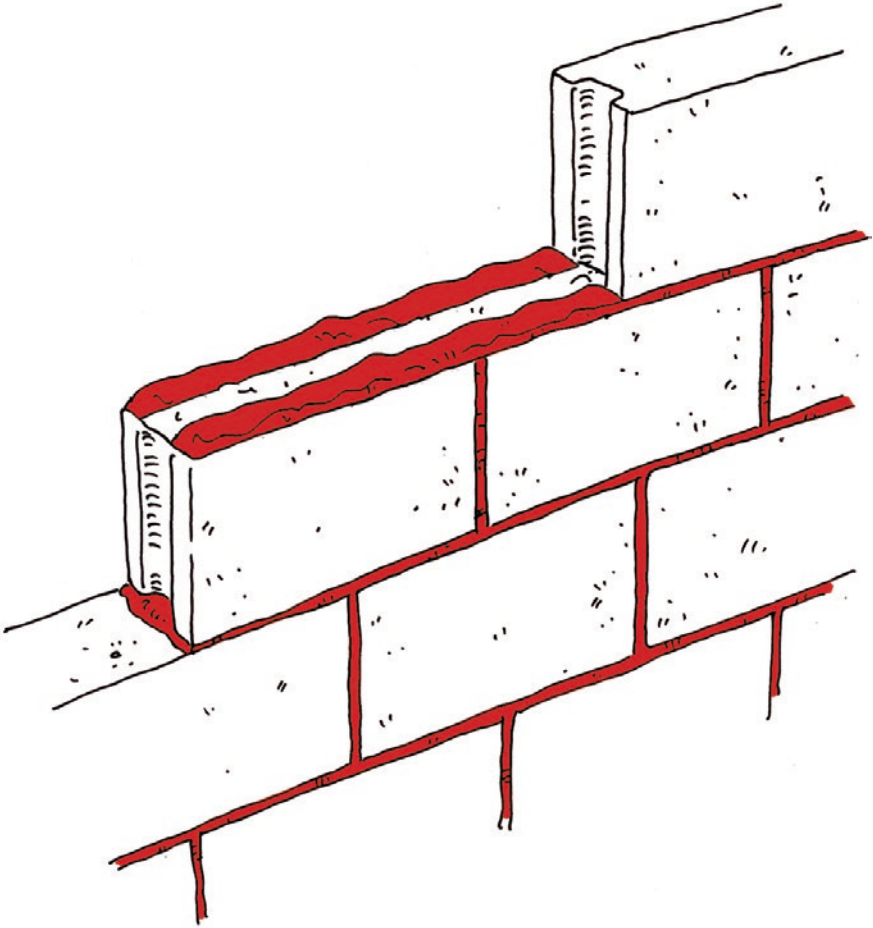

Cement mortar mix (1:4)

Mix the mortar:



1 part
cement

+



4 parts clean sand
(washed and dry)

+

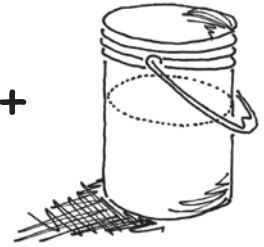

3/4 part
clean water



1. Make a pile with the sand and the cement but without water.

Use 1:3 mix ratio
for 15cm or less wall thickness



2. Mix the pile without water and move it twice with a shovel.



3. Add the water and mix again.

Add the water
only at the end.

Cement-lime mortars

Cement-lime mortar

has lower compressive strength than simple cement mortar but offers a better workability, higher elasticity, and is more economical.

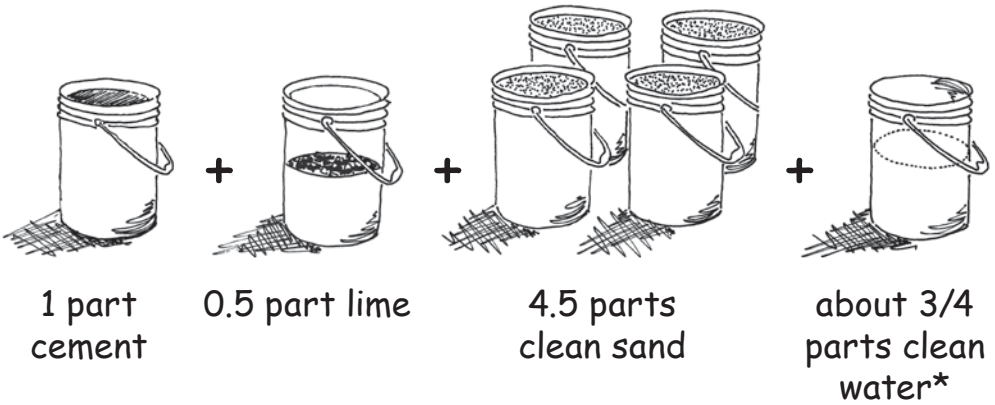

* enough water to get a good workability

Recommended mortar mix proportions:

	Cement	Lime	Sand
ideal	1	0.5	4.5
	1	1	6
minimum	1	2	9

Masonry walls height

The width of masonry unit defines the wall height.

- Bricks: maximum height = 25 x wall width
- Blocks: maximum height = 22 x wall width
- **Maximum wall height in all cases: 3m**

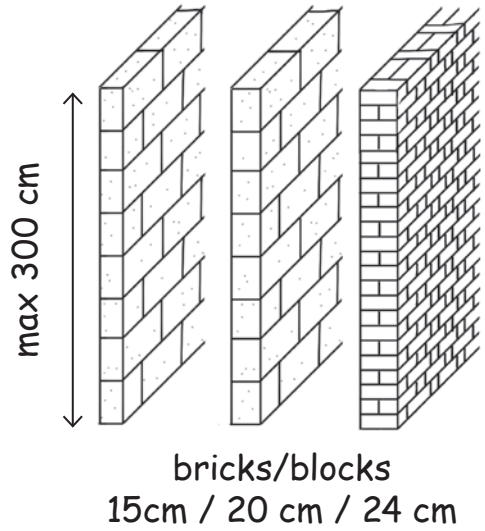
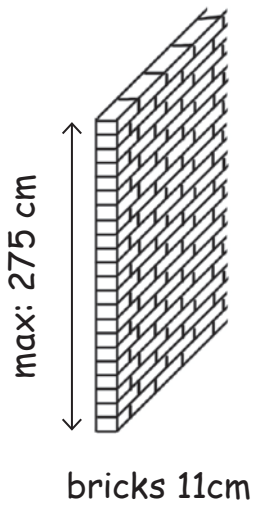
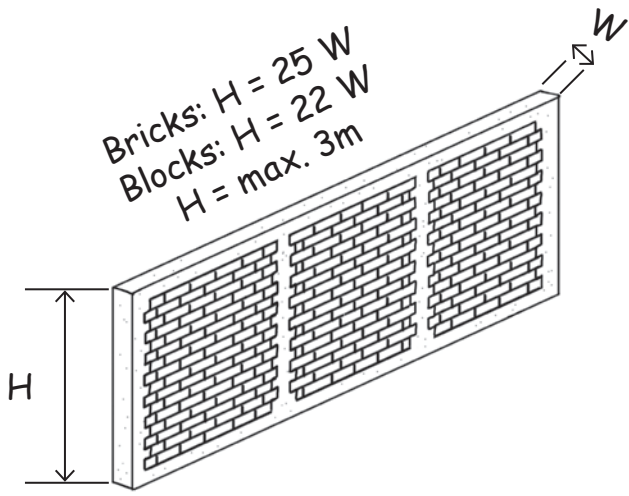

http://www.developmentbookshelf.com/doi/book/10.3362/9781780449883 - Monday, January 22, 2018 6:25:39 AM - IP Address: 193.5.216.100

Masonry bonds

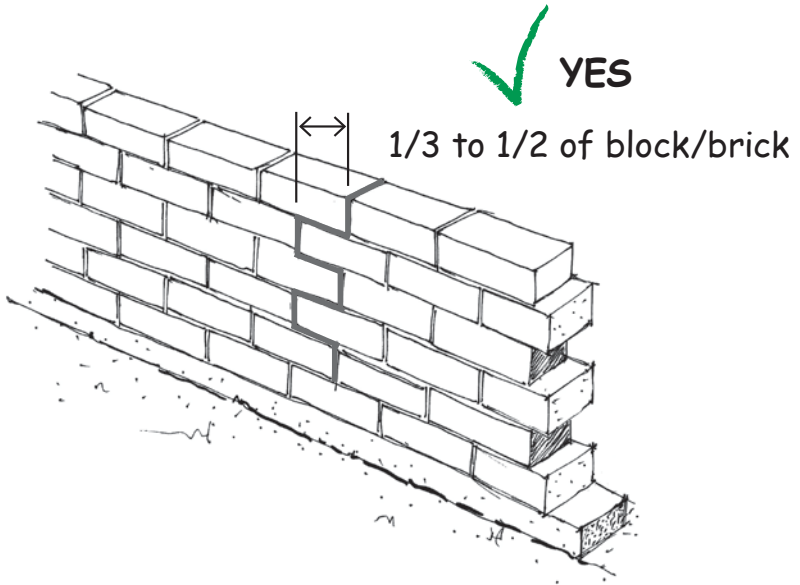

Solid wall = running bond -
vertical joints are not continuous.

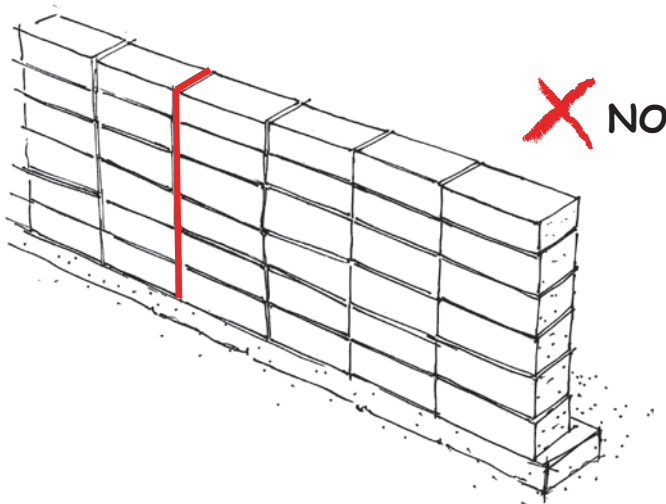

Weak wall = stack bond -
vertical joints are continuous.

Toothing

Toothing:
with bricks 5 cm
with blocks 5-10 cm

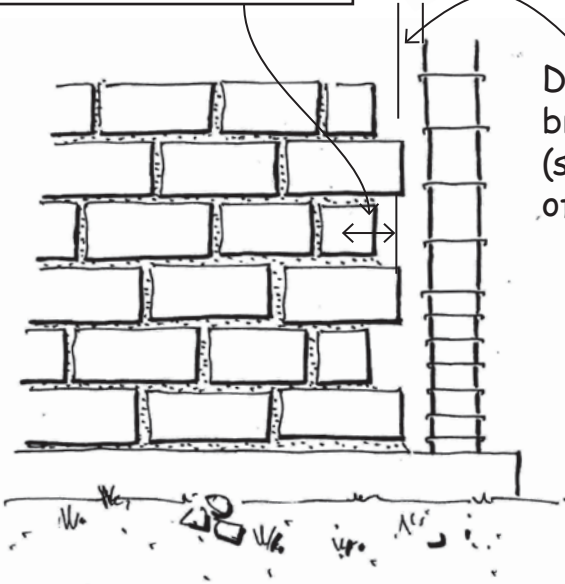

Distance from blocks or bricks: **minimum 3 cm** (same length as last joint of thumb).

Toothing too big.

If toothing is too big, concrete cannot penetrate properly.

Also, the weight of the concrete may cause bricks or blocks to break off during the pouring process.

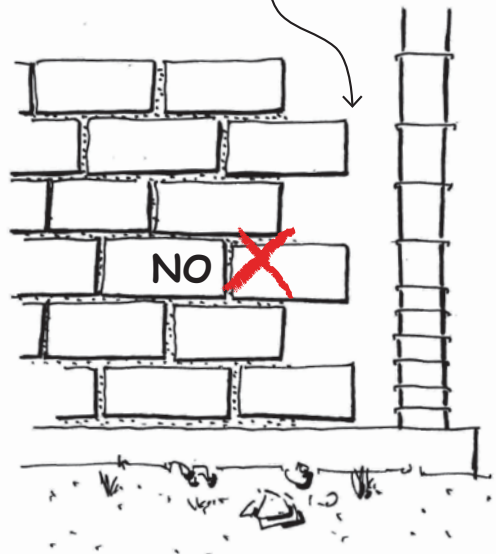

Preparing the masonry units



Soak the blocks in water for a while...

... or ...

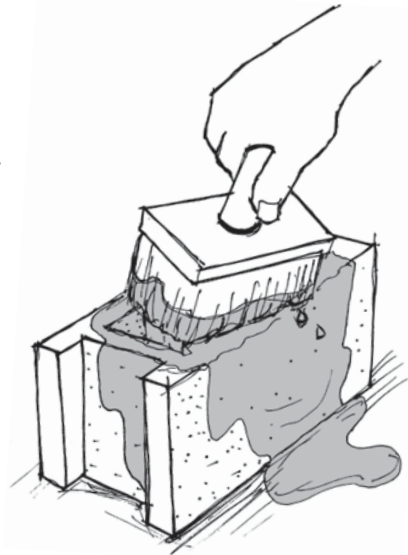

... water them with a brush before use.

... or ...



... water all blocks together.

Good masonry practice - 1

Use a plank as guide to ensure the wall is in plumb and straight.

Place blocks one course at a time

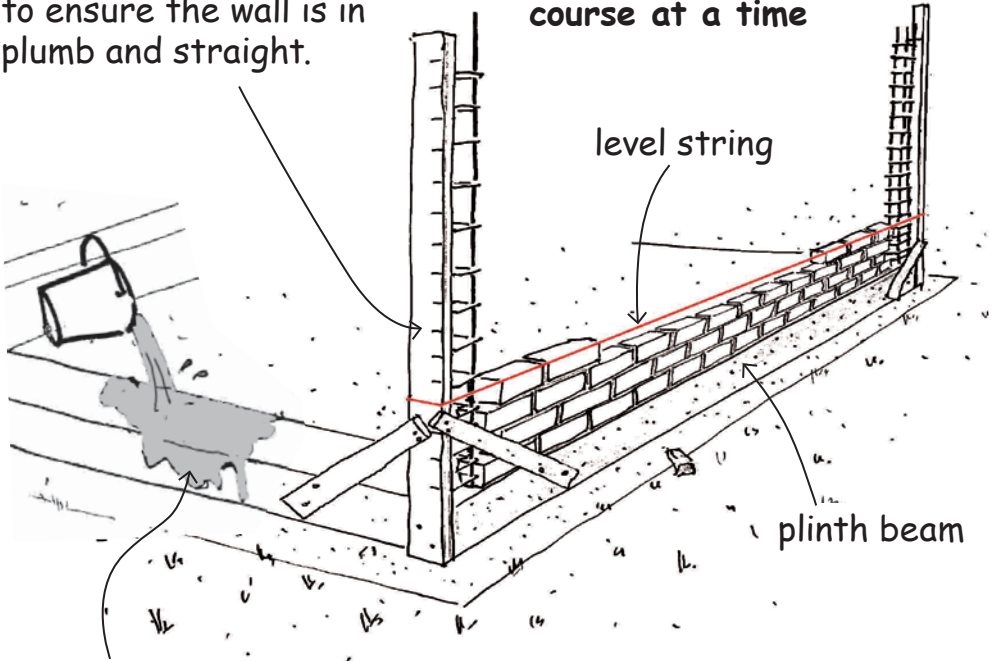

Cure the concrete with water before laying the blocks.

Important: fill vertical joints with mortar

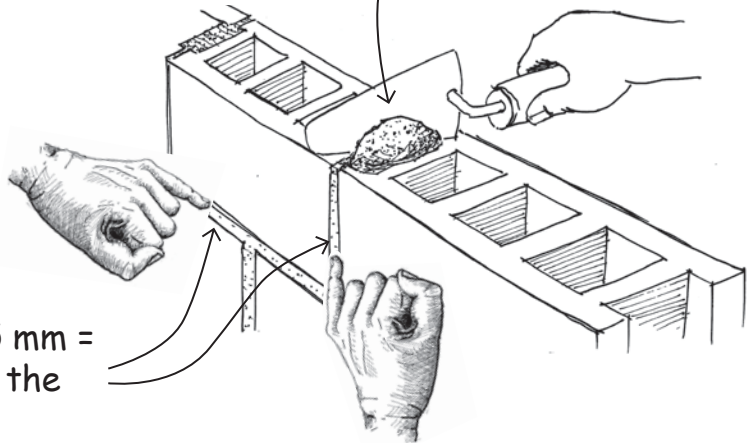

Joints: 10-15 mm = the width of the little finger

Good masonry practice - 2

Don't build more than six courses of masonry per day. And then add a seismic band if needed.

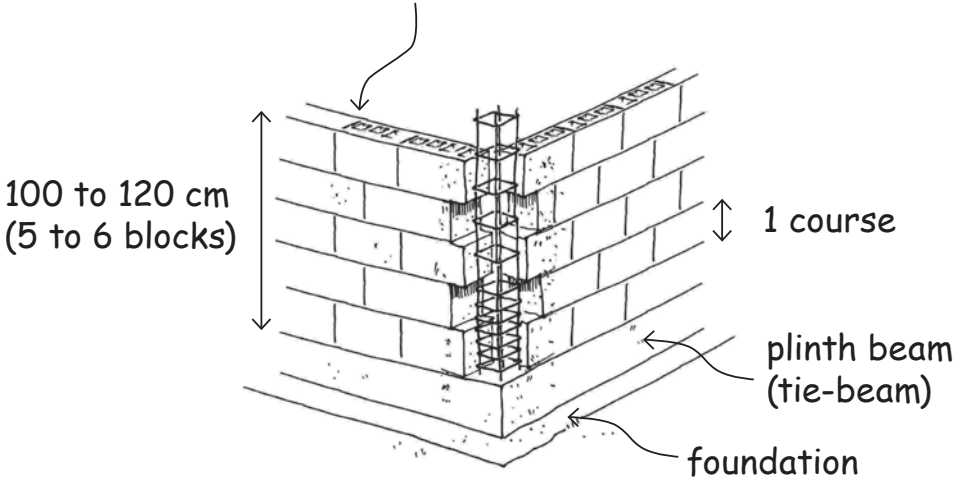

Protect the wall in warm weather: mortar must not dry out in the sun.

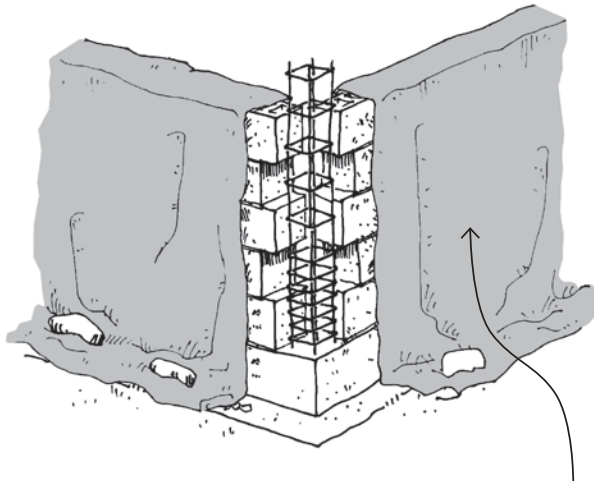

Keep wall moist by pouring water on it three times a day for seven days and/or by covering them with a plastic sheet for seven days.

Placing pipes in walls

✓ YES

Place pipes in block holes.

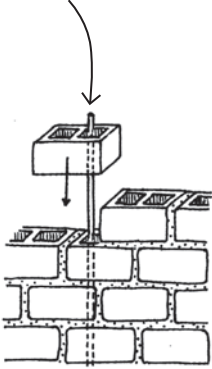

✓ YES

Place pipes in service duct.

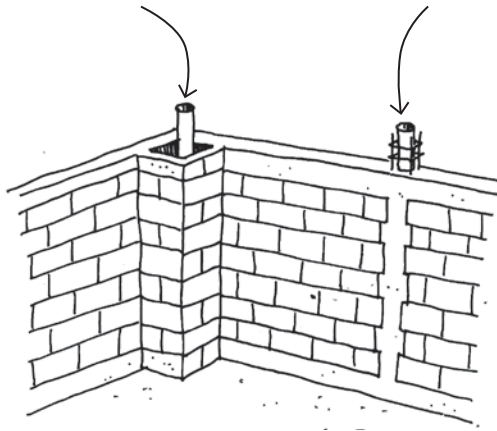

✗ NO

Don't place pipes in walls or in ties.

Don't break masonry to insert pipes.

✗ NO

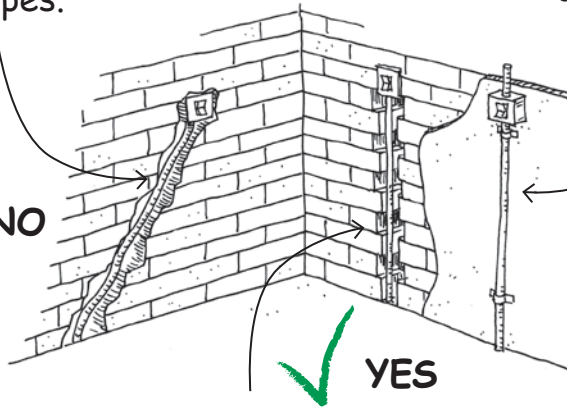

The best ways to place pipes is on top of the plaster.

✓ YES

✓ YES

Leave a space in the wall for electrical pipes. Once the pipes placed it will be filled with mortar.

11. SEISMIC REINFORCEMENTS

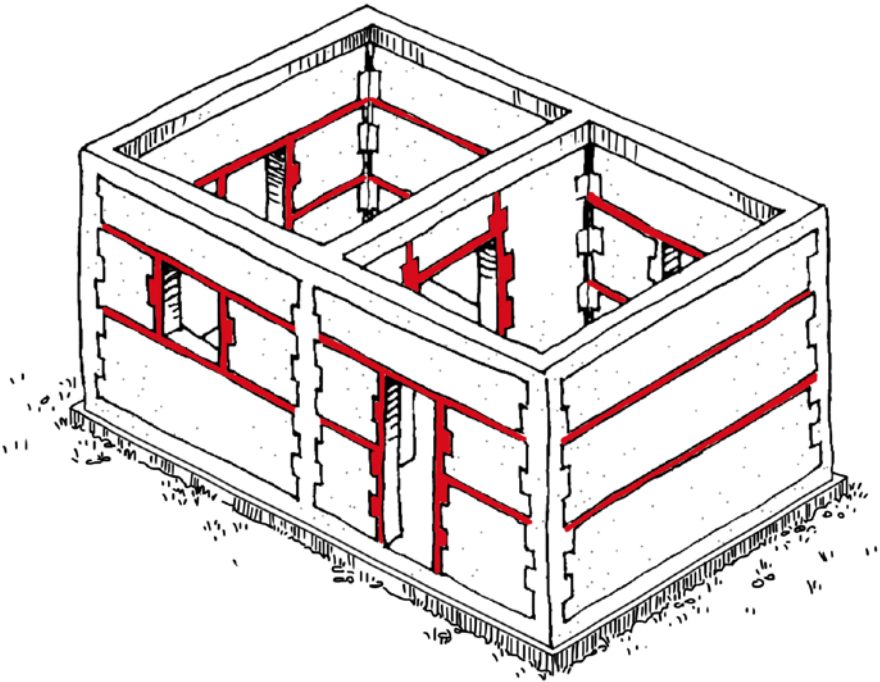

Vertical reinforcement of openings

There are two types of reinforcements of openings, vertical and horizontal. They are equally valid. For horizontal reinforcements see p. 86.

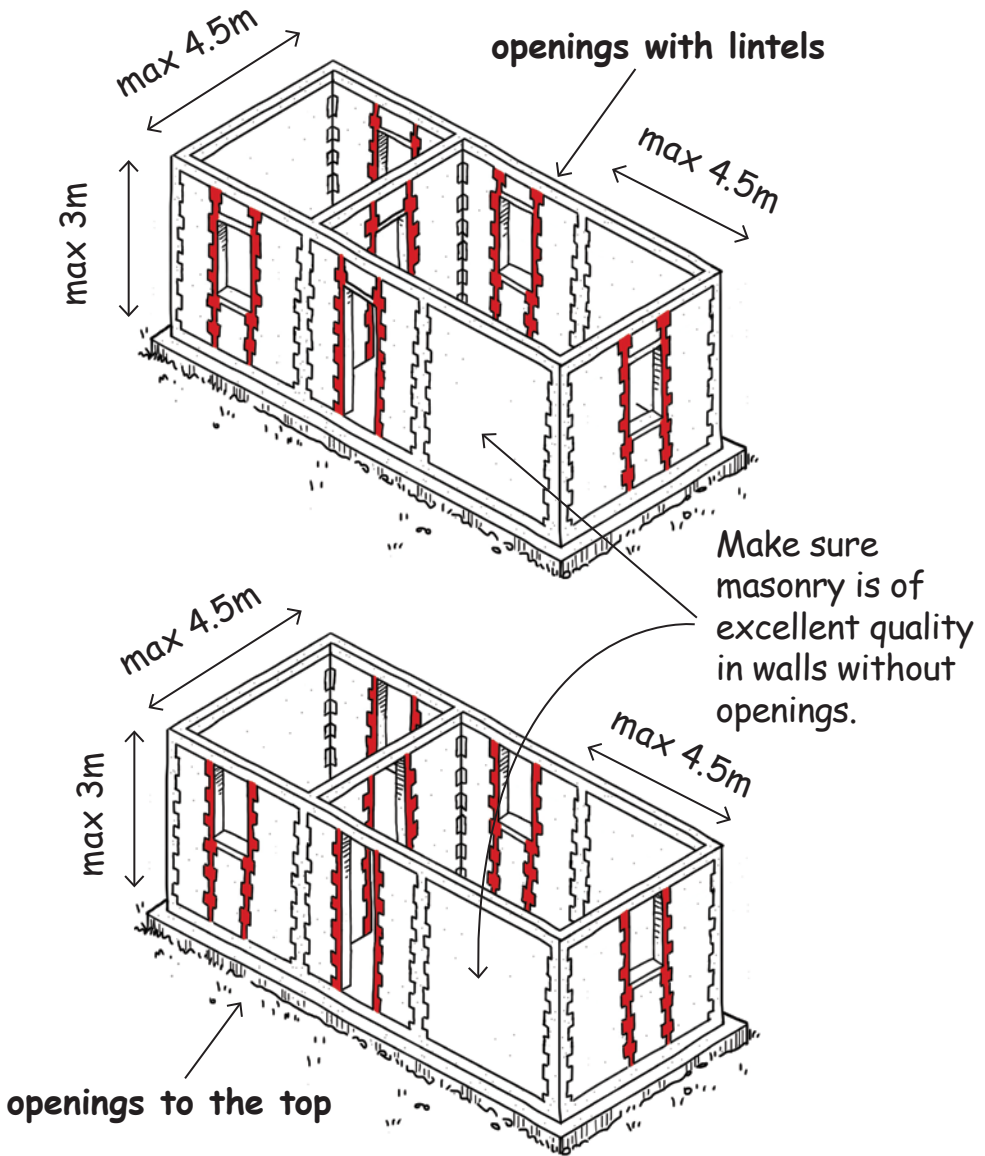

Place a vertical reinforcement on each side of every opening.

Door reinforcement

Hook the door vertical reinforcement rebars and lap 30 cm with the tie-beam rebars, under the stirrups. Do the same with the lintel band and the vertical bands.

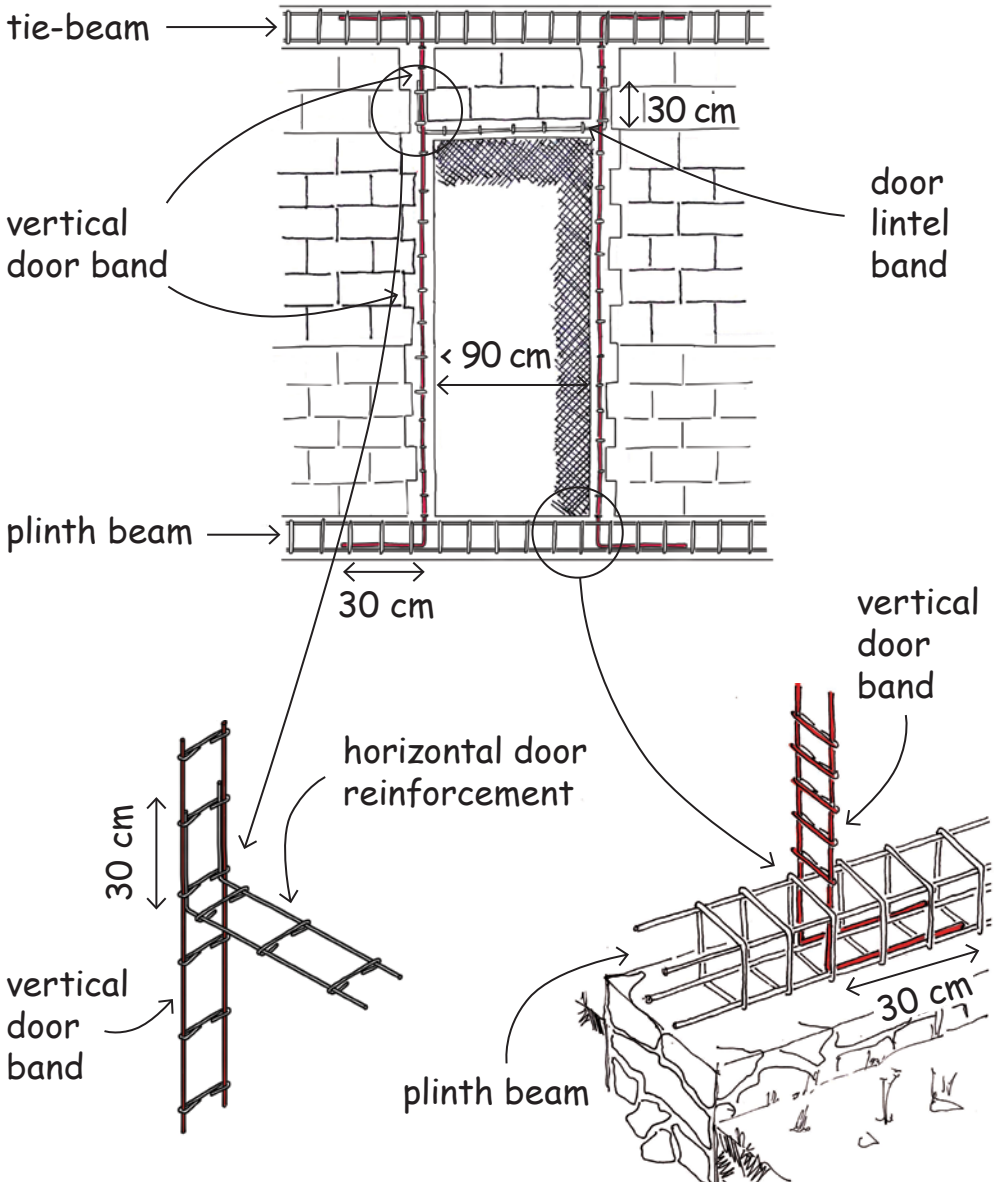

Reinforcement of small windows

For windows smaller than 90 cm.

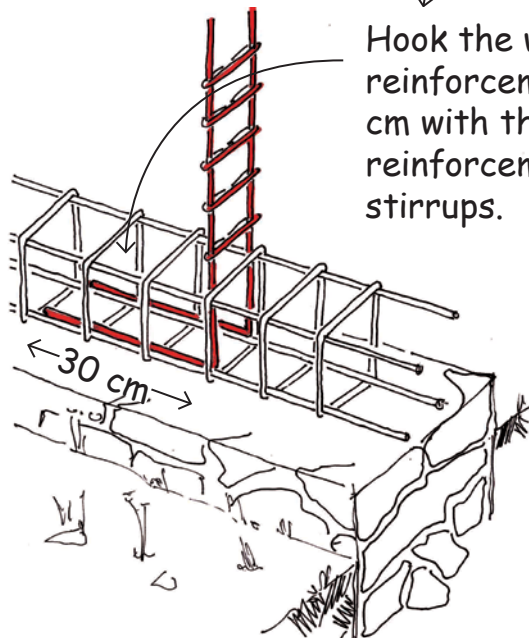
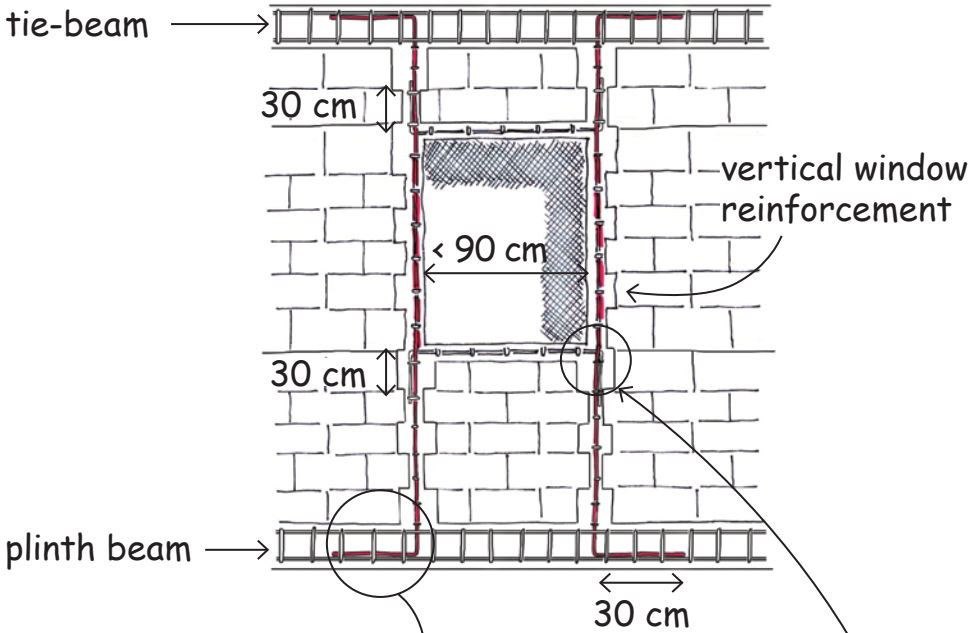

Hook the window vertical reinforcement and lap 30 cm with the tie-beams reinforcement, into the stirrups.

Do the same with the horizontal reinforcement and the vertical bands.

http://www.developmentbookshelf.com/doi/book/10.3362/9781780449883 - Monday, January 22, 2018 6:25:39 AM - IP Address: 193.5.216.100

Reinforcement of large windows

For windows larger than 90 cm.

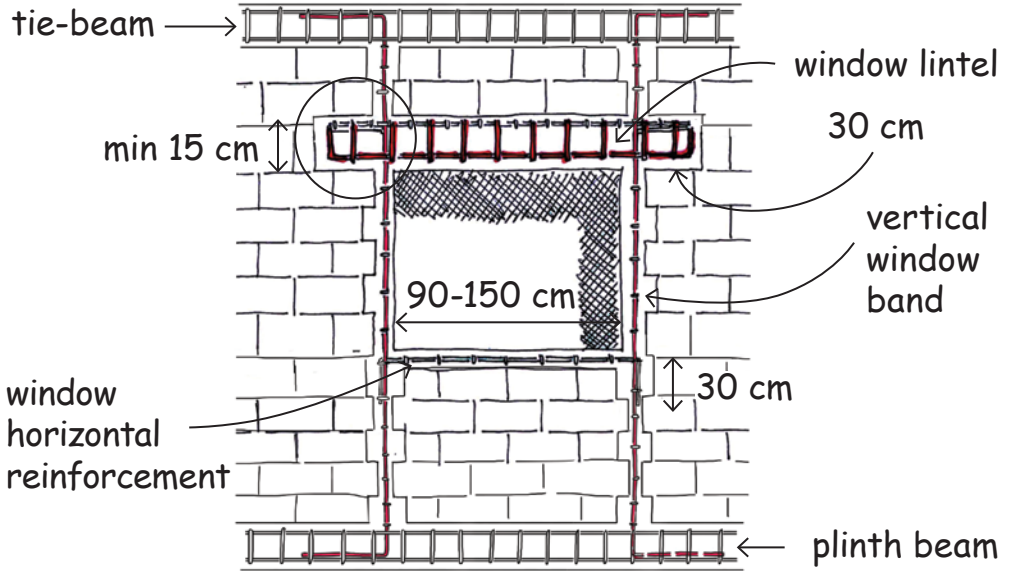

stirrups at 15 cm spacing

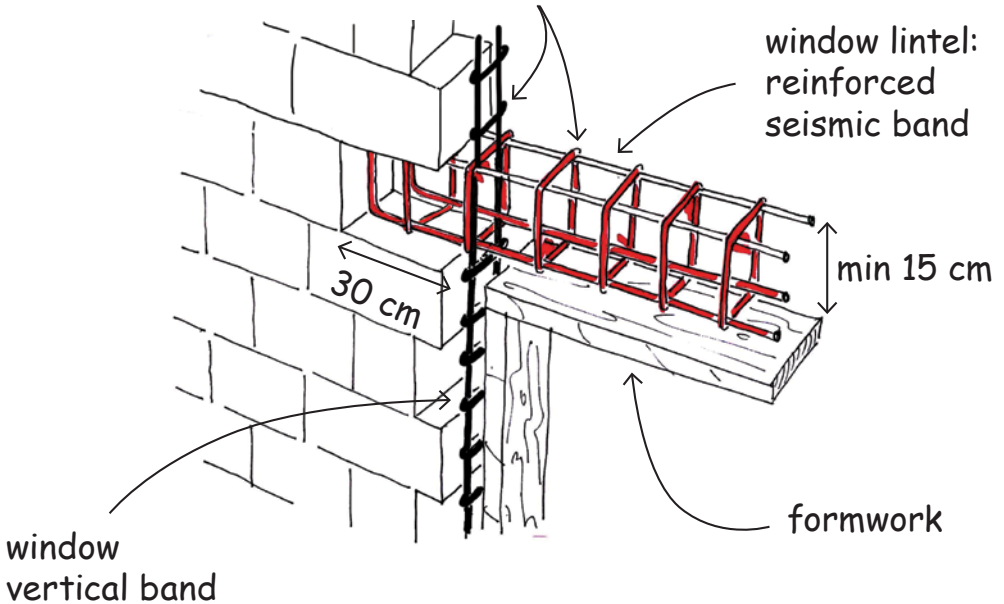

Horizontal reinforcements (seismic bands)

Place horizontal reinforcements (seismic bands) below and above every opening. Bands should be placed about every 1.2 m.

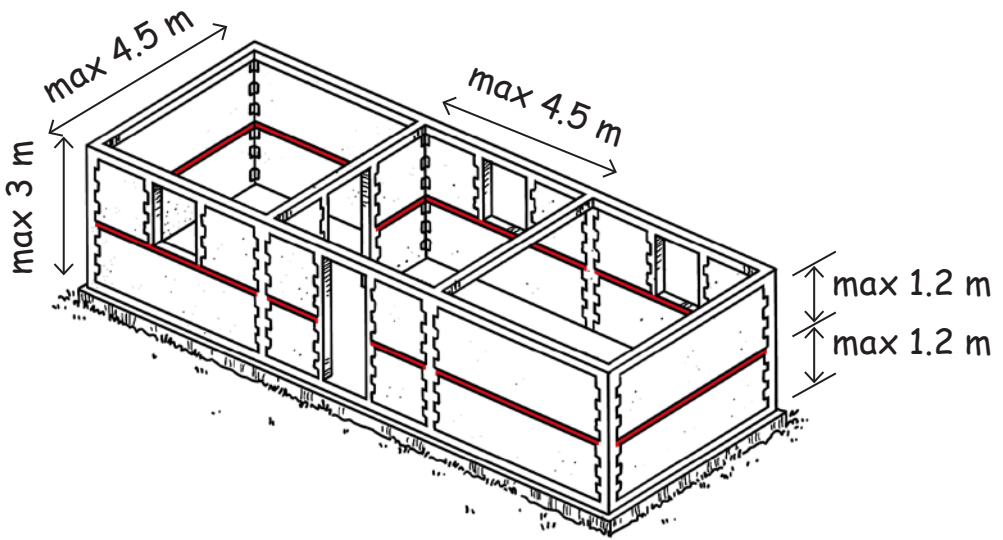
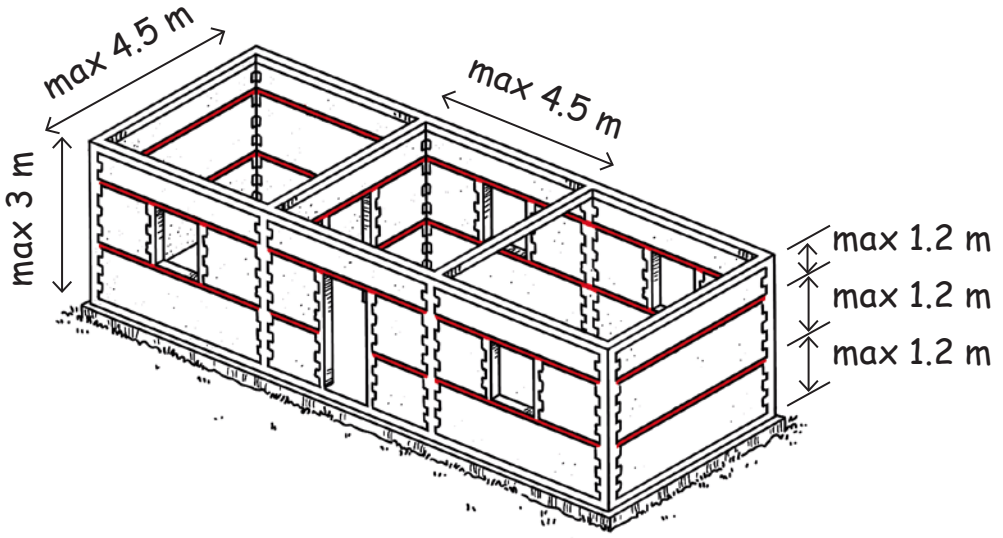

Seismic bands

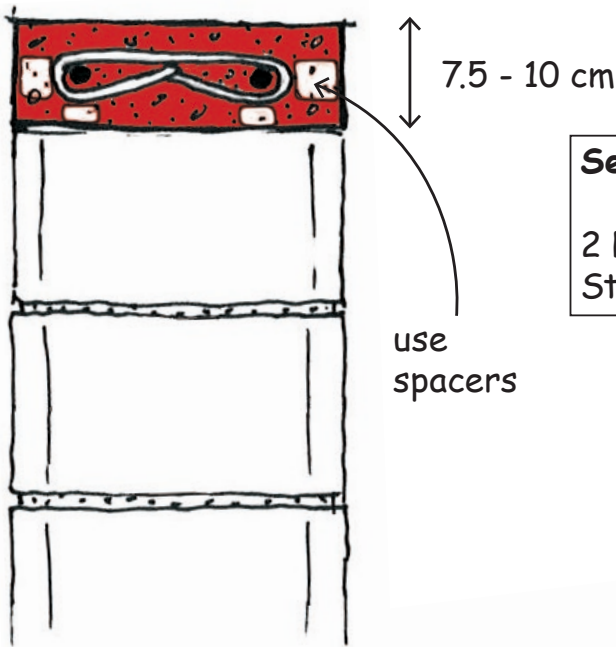

Seismic bands:
2 Rebars: 10 mm
Stirrups: 6 mm @15 cm

use
spacers

Roughen up the top surface of the bands to increase bonding of the masonry mortar.

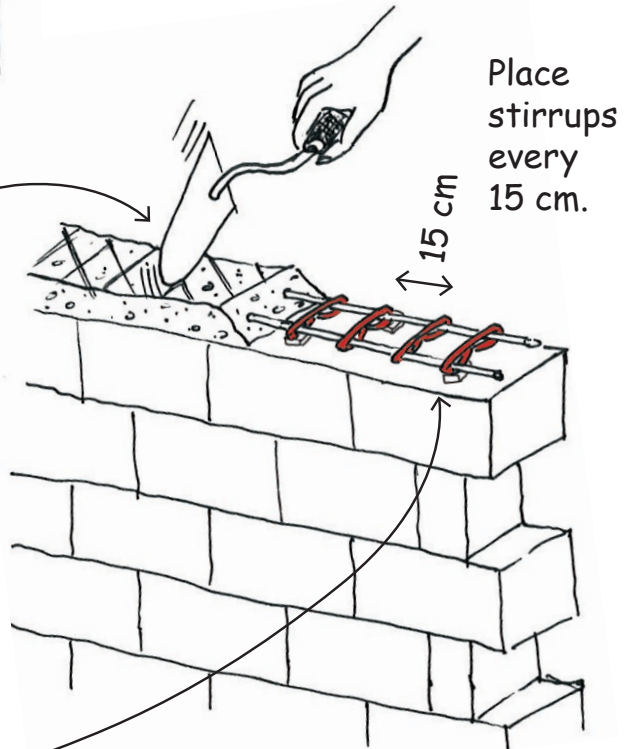

Place
stirrups
every
15 cm.

Place reinforcements
of spacers.

Connections

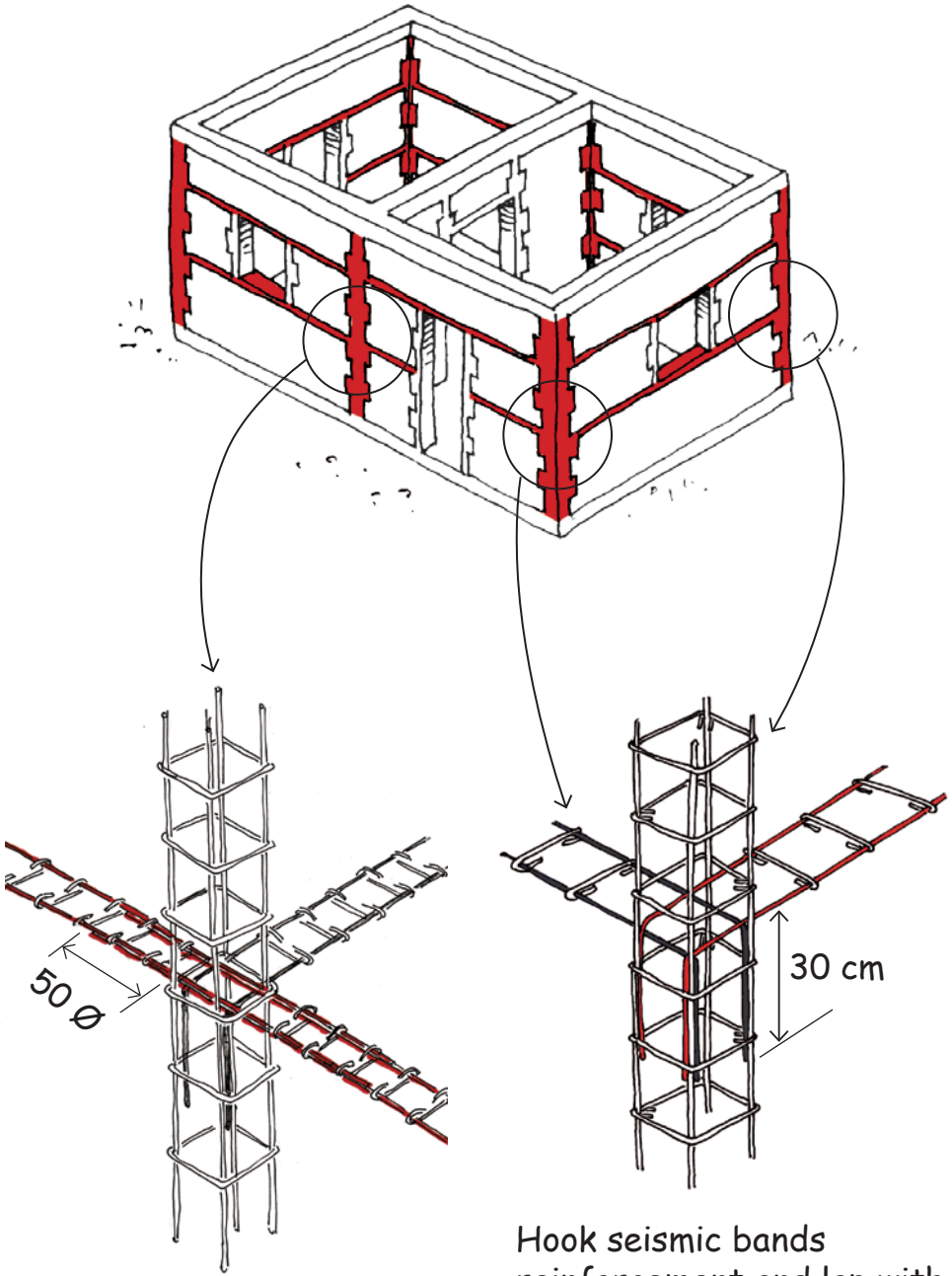

Respect overlapping length.

Hook seismic bands reinforcement and lap with tie-column reinforcement.

http://www.developmentbookshelf.com/doi/book/10.3362/9781780449883 - Monday, January 22, 2018 6:25:39 AM - IP Address: 193.5.216.100

Reinforcement of small windows

For windows smaller than 90 cm.

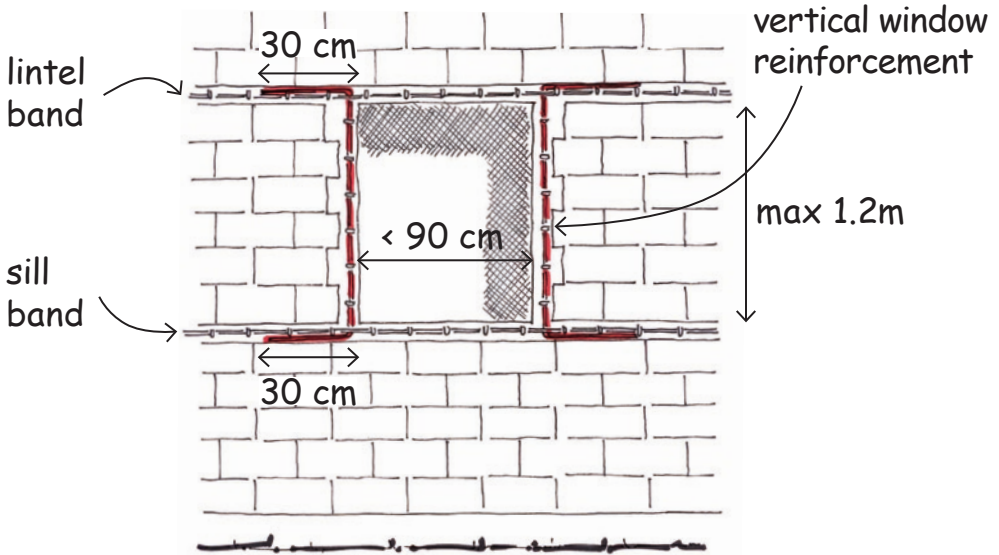

Hook the window reinforcement and lap 30 cm with the seismic band reinforcement, into the stirrups.

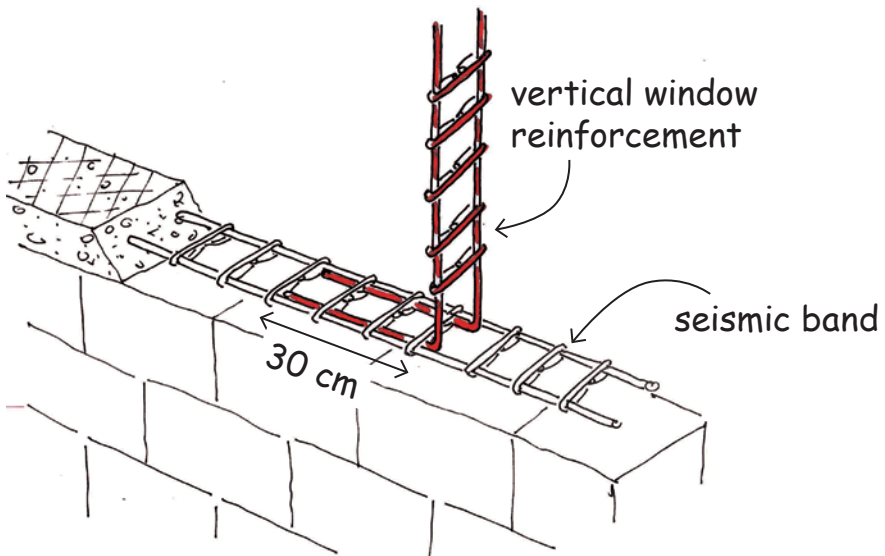

Reinforcement of large windows

For windows larger than 90 cm.

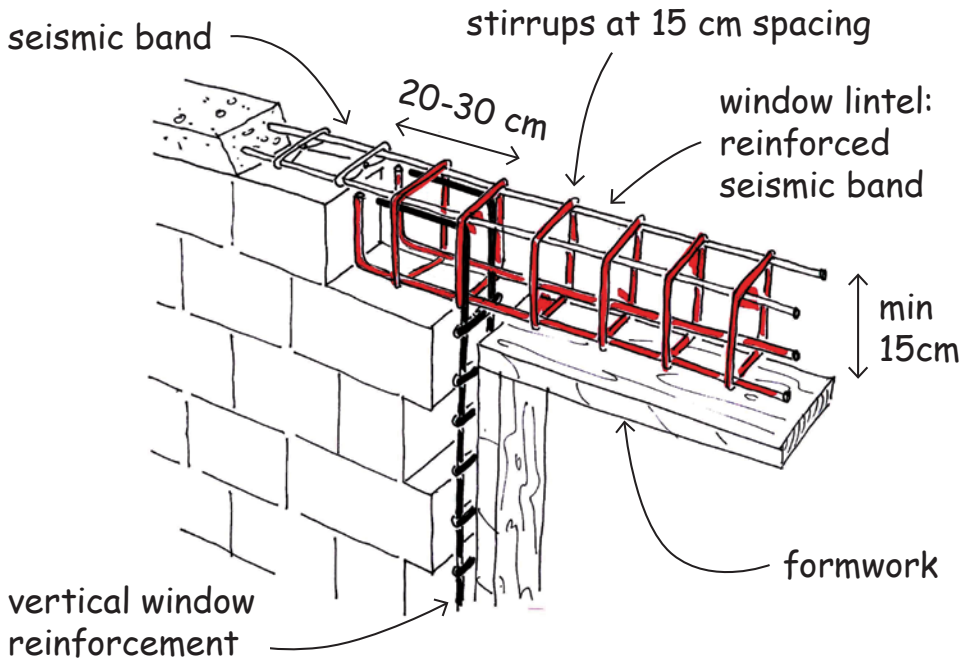
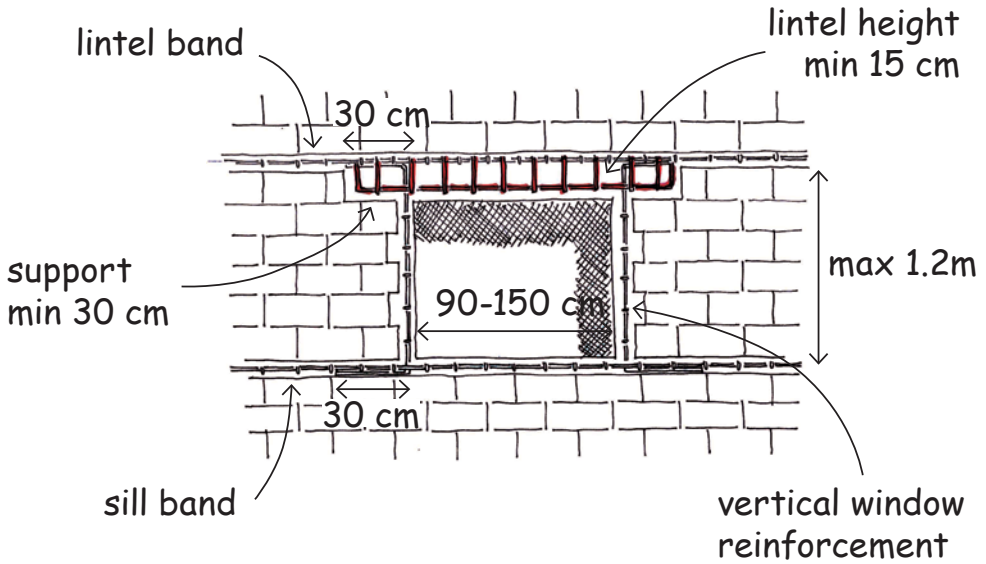

http://www.developmentbookshelf.com/doi/book/10.3362/9781780449883 - Monday, January 22, 2018 6:25:39 AM - IP Address: 193.5.216.100

Creating shear walls using vertical reinforcements

Vertical bands are 'half tie-columns' with **only two rebars**.

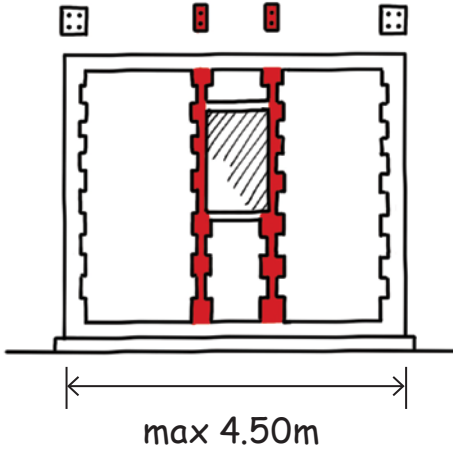

Vertical bands:
(for openings)

Width: 10 cm

2 Rebars: 10 mm

Stirrups: 6 mm (@ 15cm)

If a wall between openings is required to act as a shear wall, the vertical reinforcement is identical to a tie-column with **four rebars**

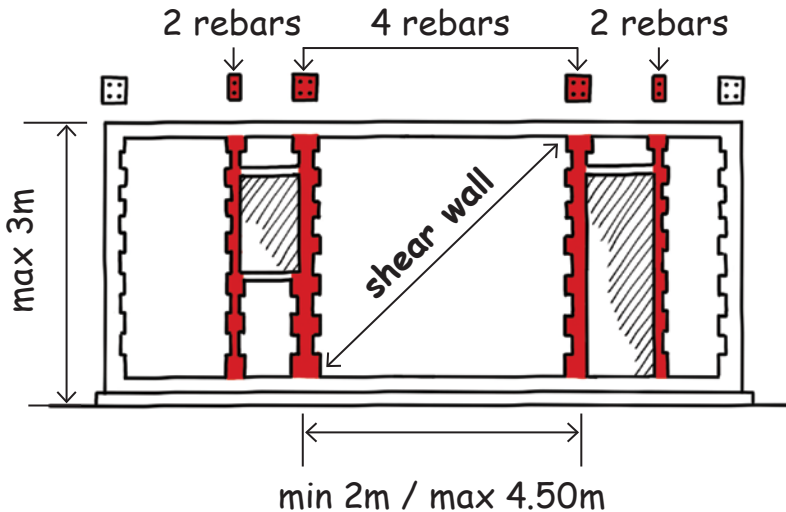

Shear walls with horizontal bands 1

In some cases it might seem impossible to provide shear walls in each facade because the owner wants too many windows.

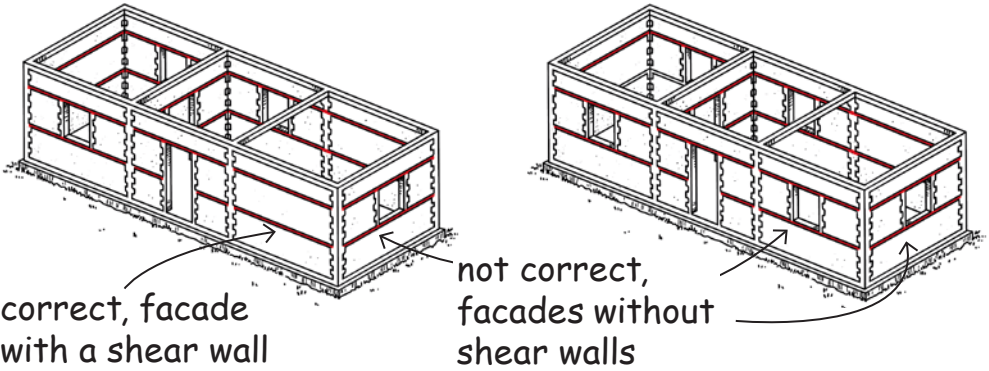

In these cases shear walls are created by increasing the reinforcements on the side of some specific openings.

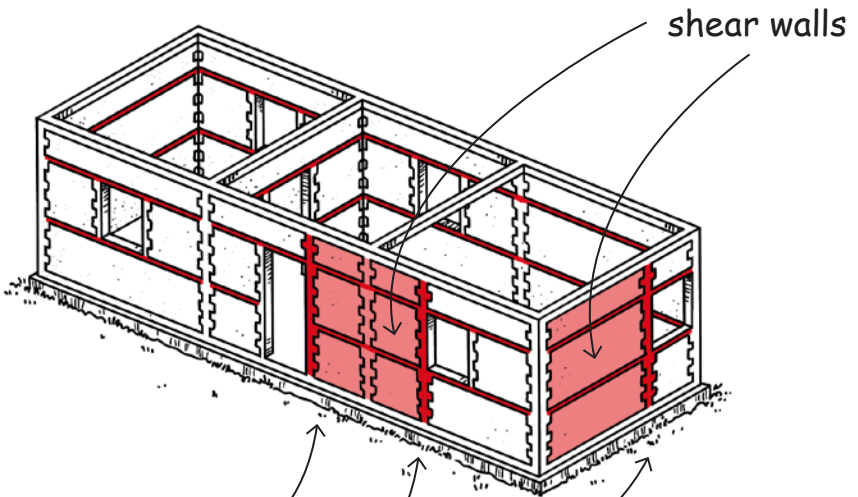

Reinforcement around openings become tie-columns.

Shear walls with horizontal bands 2

The vertical reinforcements of the openings (with 2 rebars) can be made like tie-columns with 4 rebars and extending them down to the plinth and up to the ring beam.

Reinforcement of opening
with 2 rebars

Tie-columns with 4
rebars

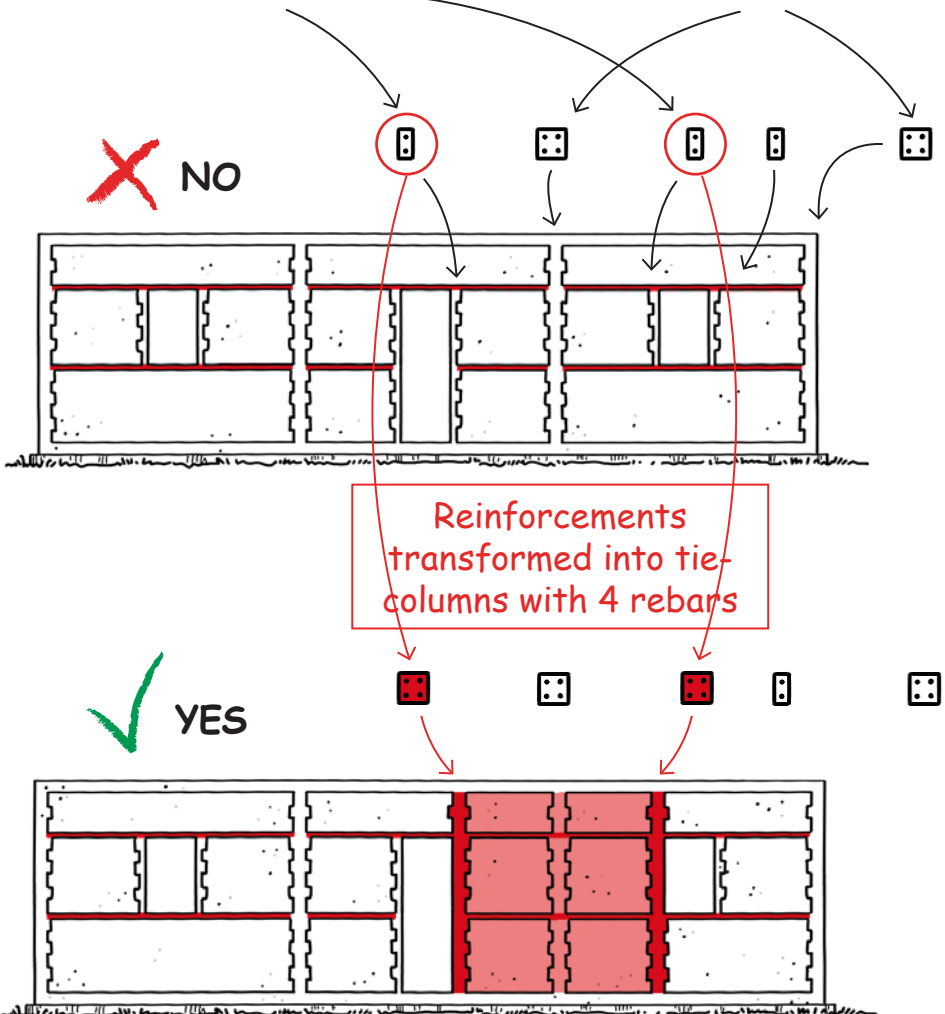

12. SLAB

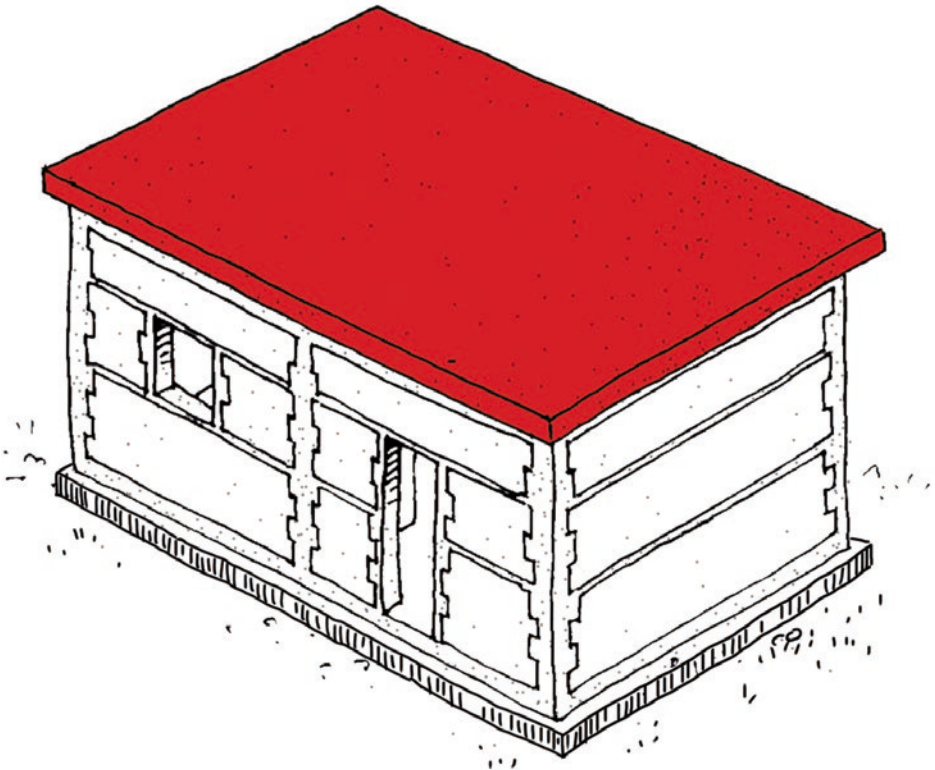

Placing of slab reinforcement

Placement of primary rebars.

Step 1

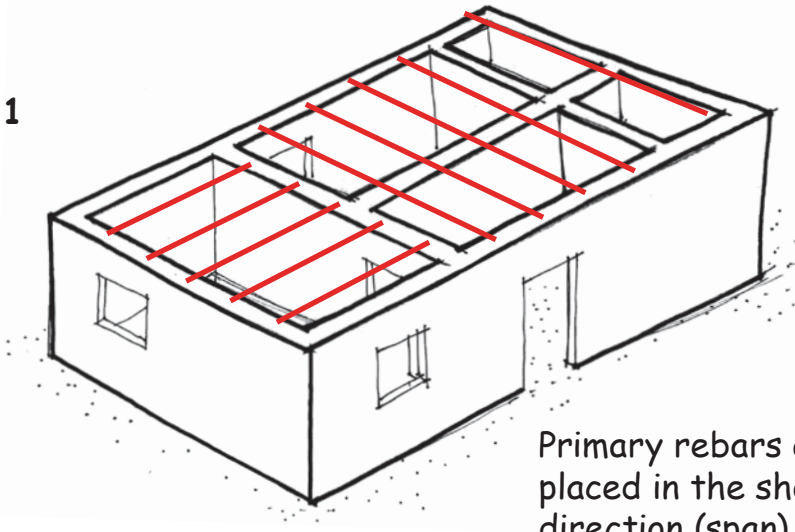

Primary rebars are placed in the shorter direction (span).

Placement of secondary rebars.

Step 2

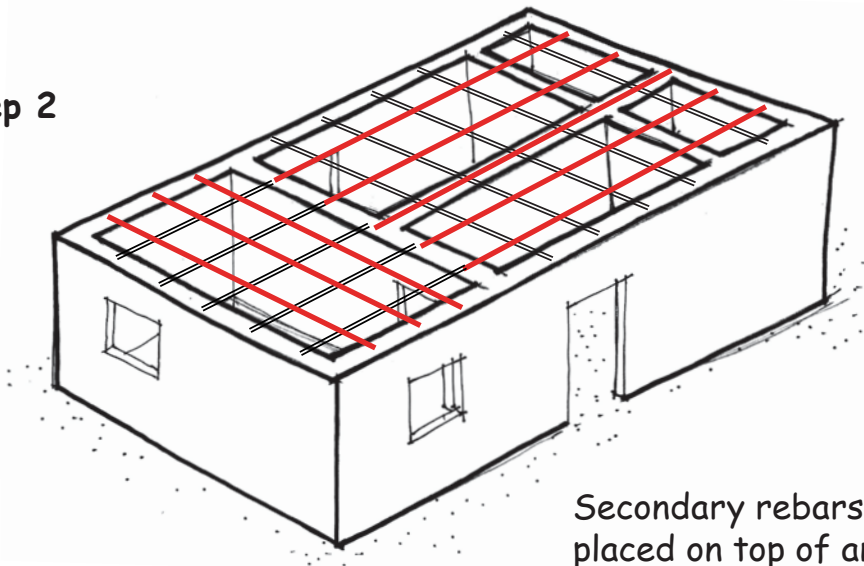

Secondary rebars are placed on top of and perpendicular to the primary rebars.

Hollow block slab: formwork

✓ **GOOD FORMWORK**

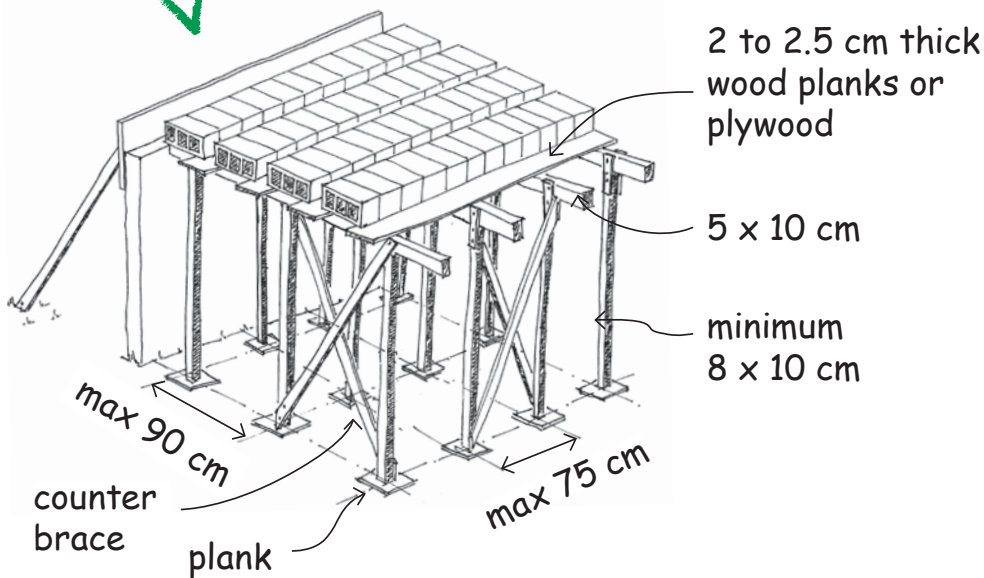

✗ **BAD FORMWORK**

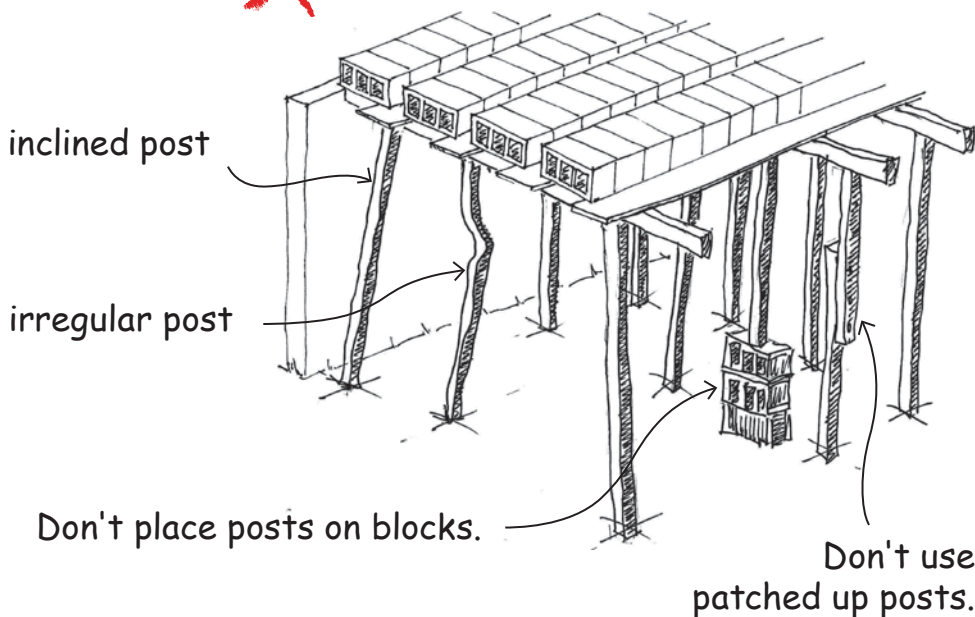

Hollow block slab: main reinforcement

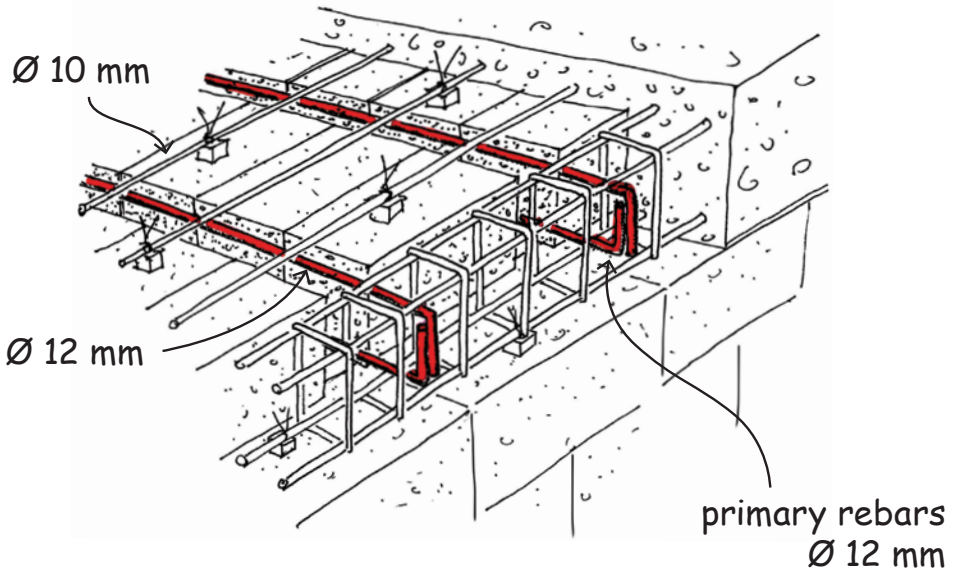

To ensure a good connection, it is important to insert the hooked slab rebars deep into the bond beam.

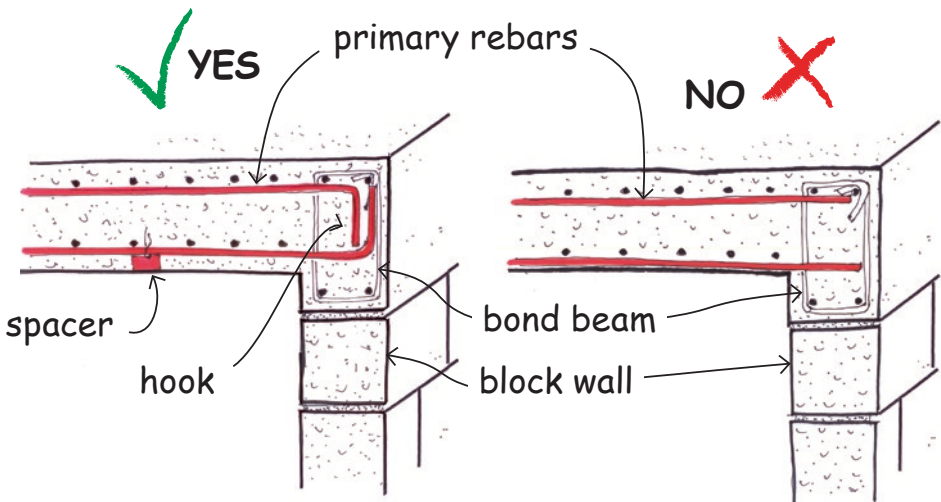

Hollow block slab: secondary rebar

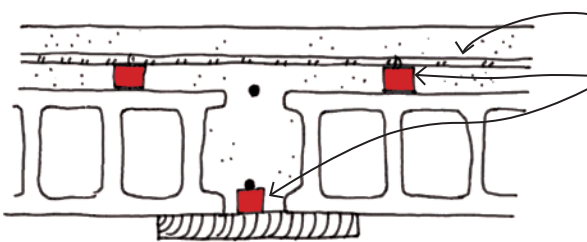
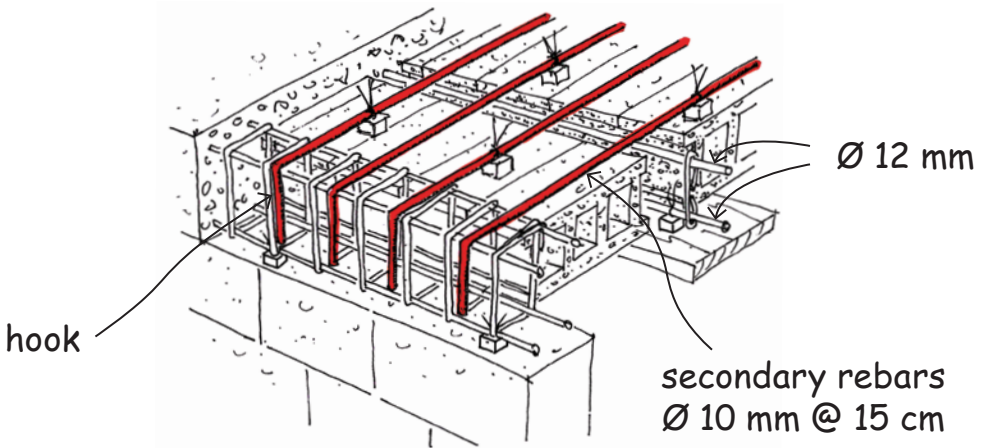

secondary rebar

spacers

Secondary rebar must be placed in the middle of the concrete covering the hollow blocks with spacers.

 YES

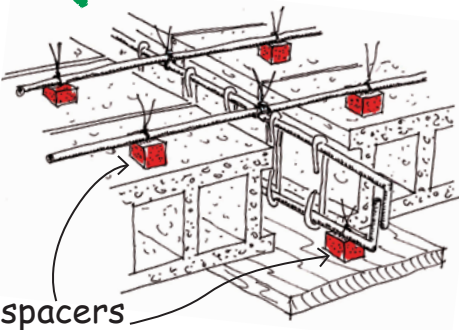

 NO

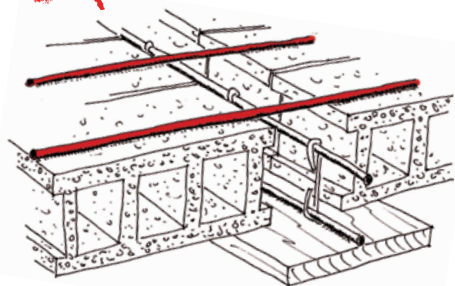

Placing pipes in hollow block slabs

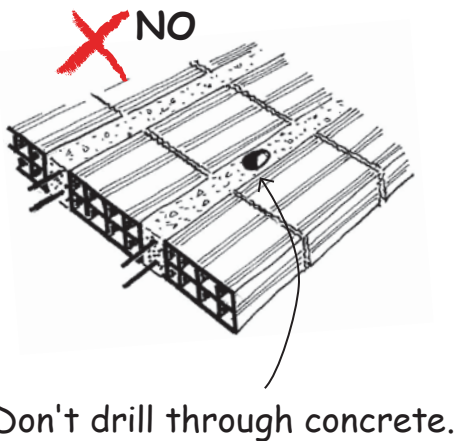
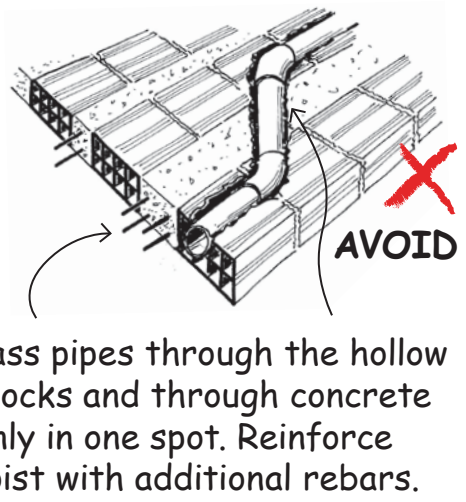
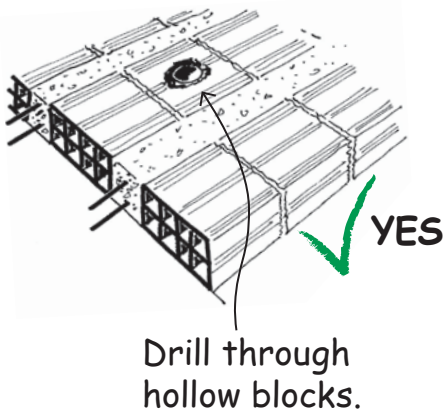
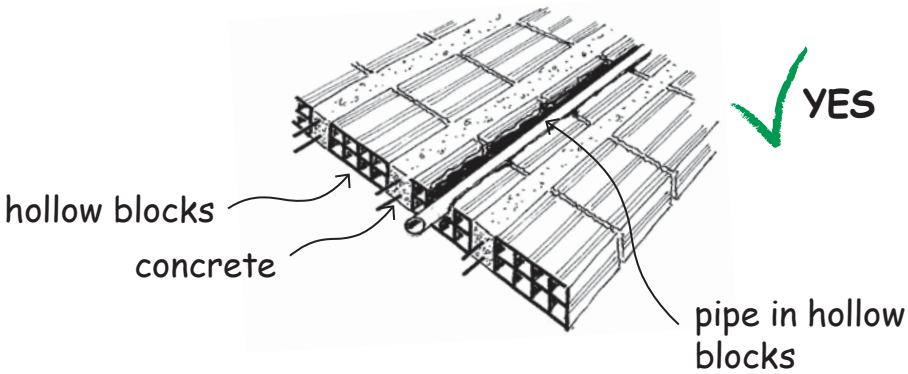

Preparing the slab for concrete

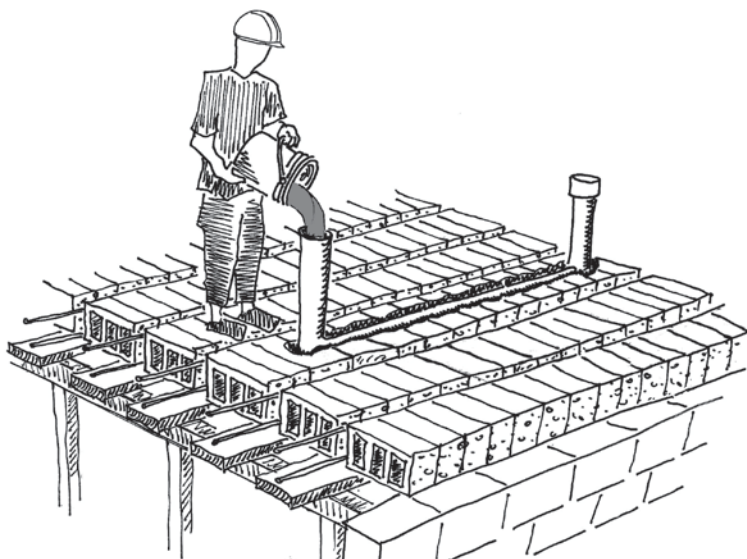

Test watertightness of the pipes by filling them with water and wait for four hours.



Water the formwork before pouring the concrete.

Pouring the concrete

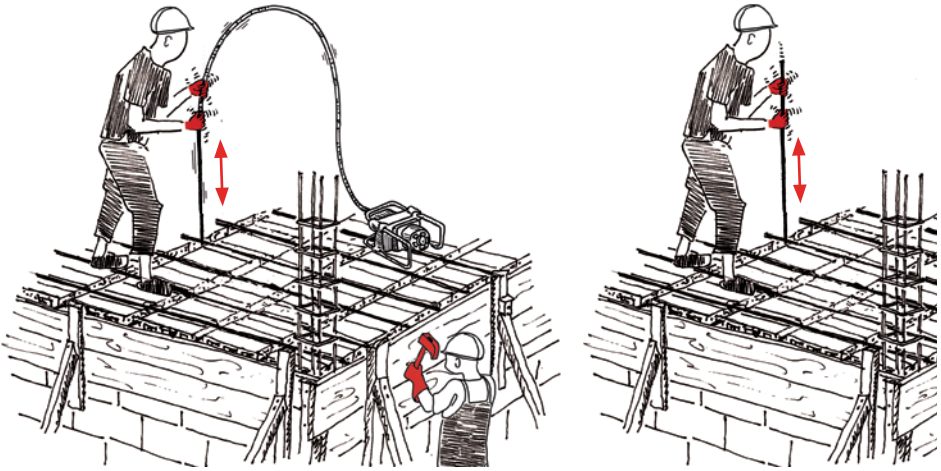

Compact the concrete with a vibrating needle or, if not available, with a steel rod and hammer.

Curing the concrete: create ponds with sand or mud and fill them with water for a week.

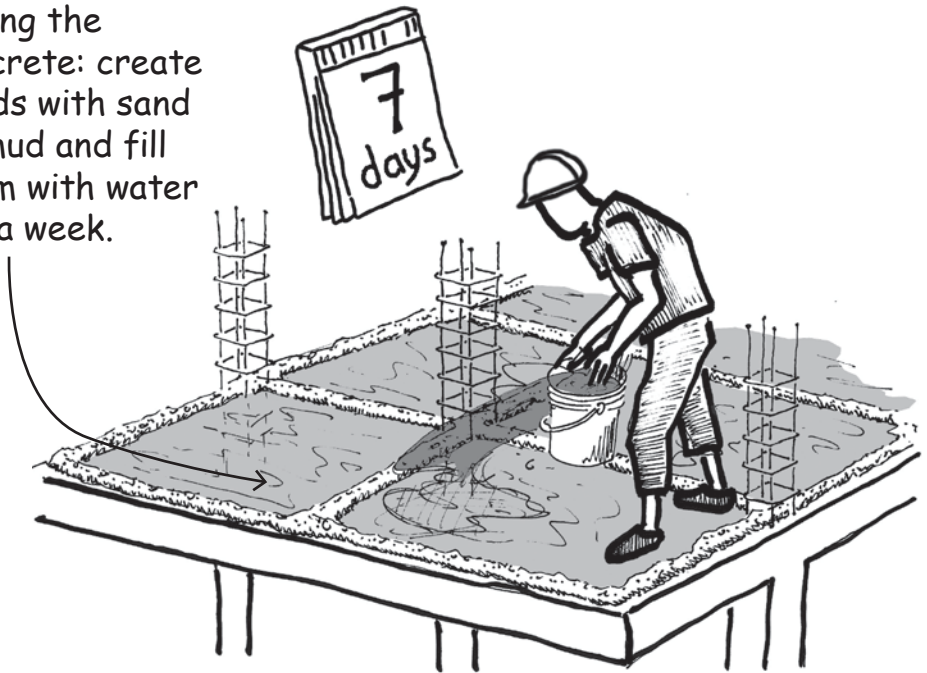

13. LIGHT ROOF

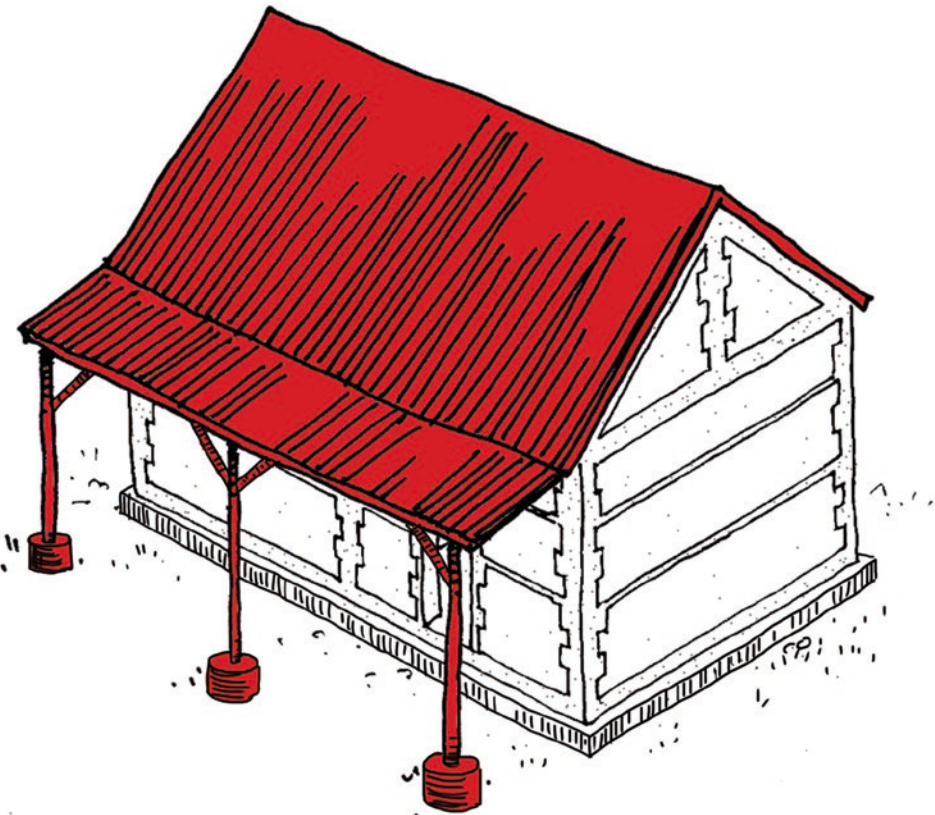

Roof shape



✓ Good
YES

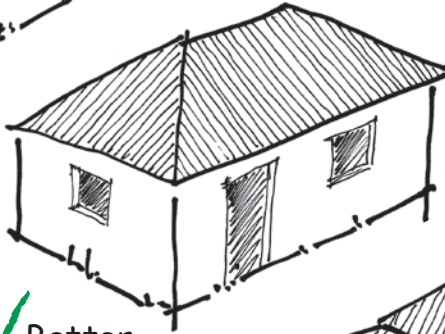

✓ Better
YES

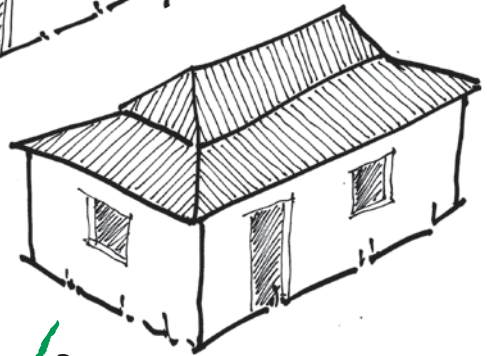

✓ Better
YES

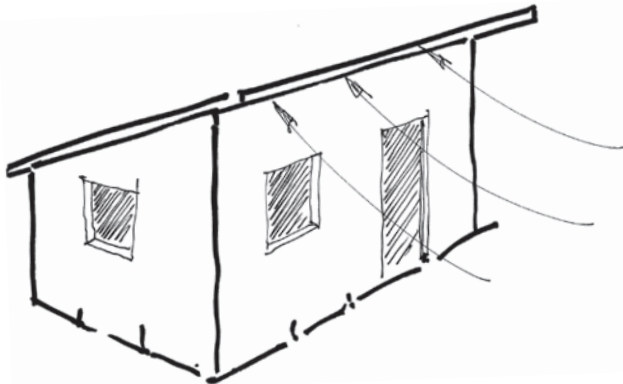

✗ Not so good
AVOID

Gable wall

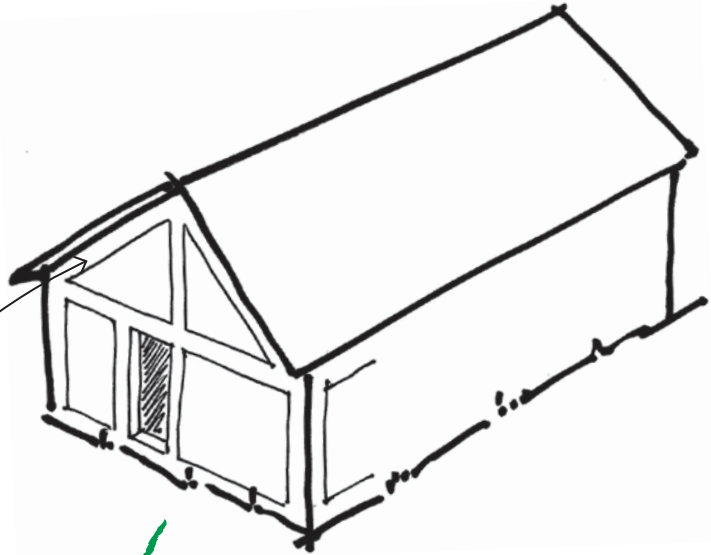

✓ YES

Concrete tie
on top of the
gable wall.

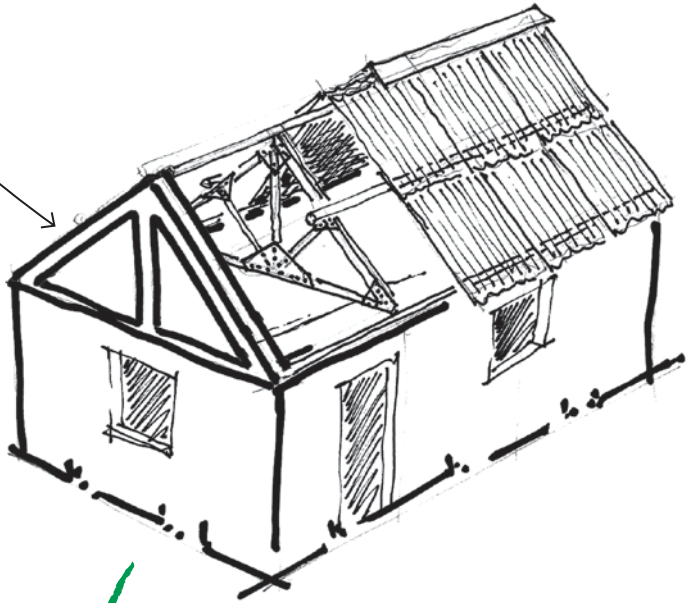

✓ YES

Roof structure - Trusses

X AVOID

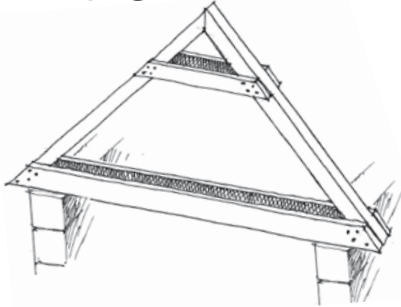

Building with planks:
AVOID
(not enough room for nails)

✓ YES

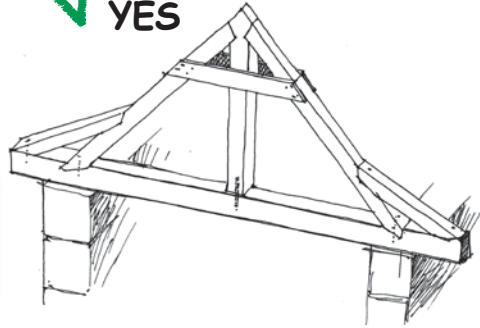

Building with solid timber:
GOOD

✓ YES

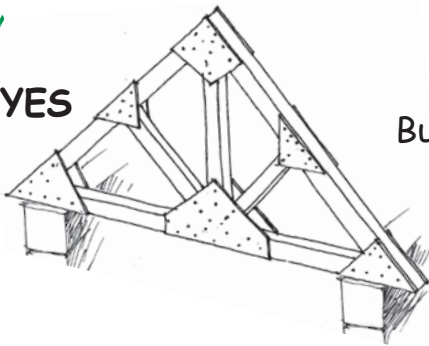

Building with plywood gusset:
BETTER!

Timber connections:

Put at least **three nails in each direction**

Length of nails should be **twice the thickness of the timber**

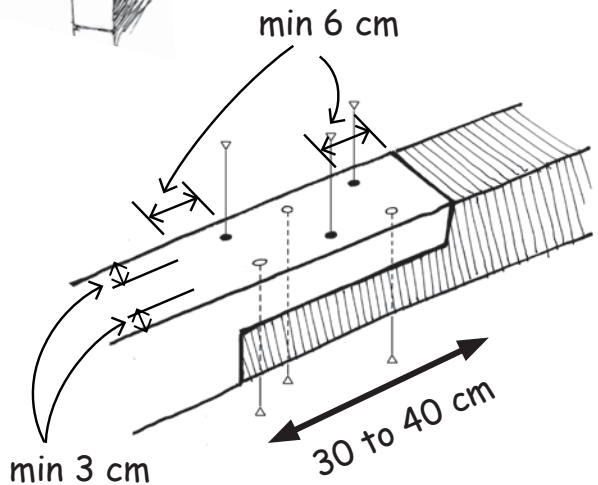

Cyclones



YES



Keep verandas independent from main roof: cyclones may tear off the verandas.



YES

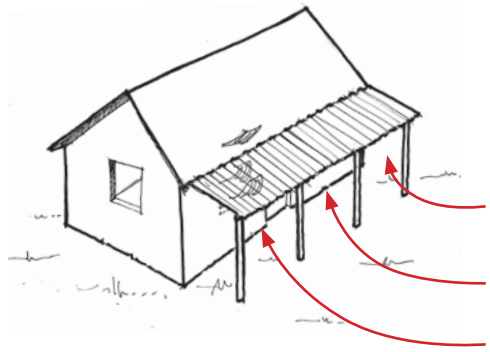

Closed gable wall

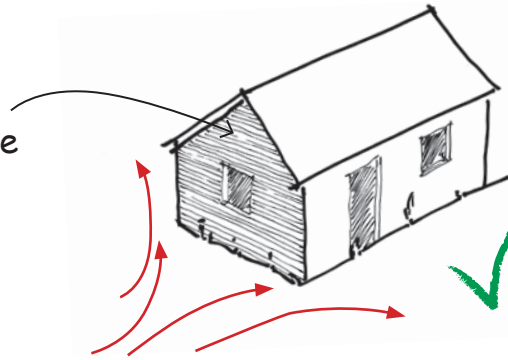

YES

NO

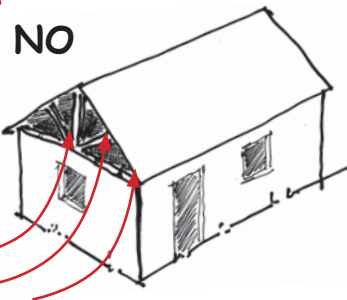

Opened gable wall

NO

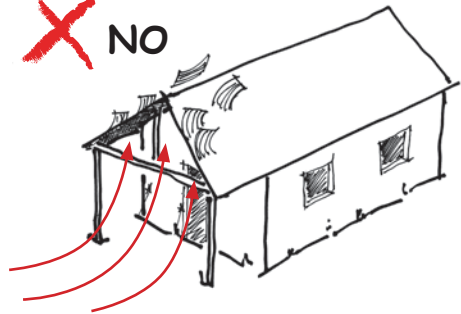

Main roof becoming veranda

If a veranda is part of the main roof, then a cyclone could tear off the whole roof.

Fastening of the veranda framing

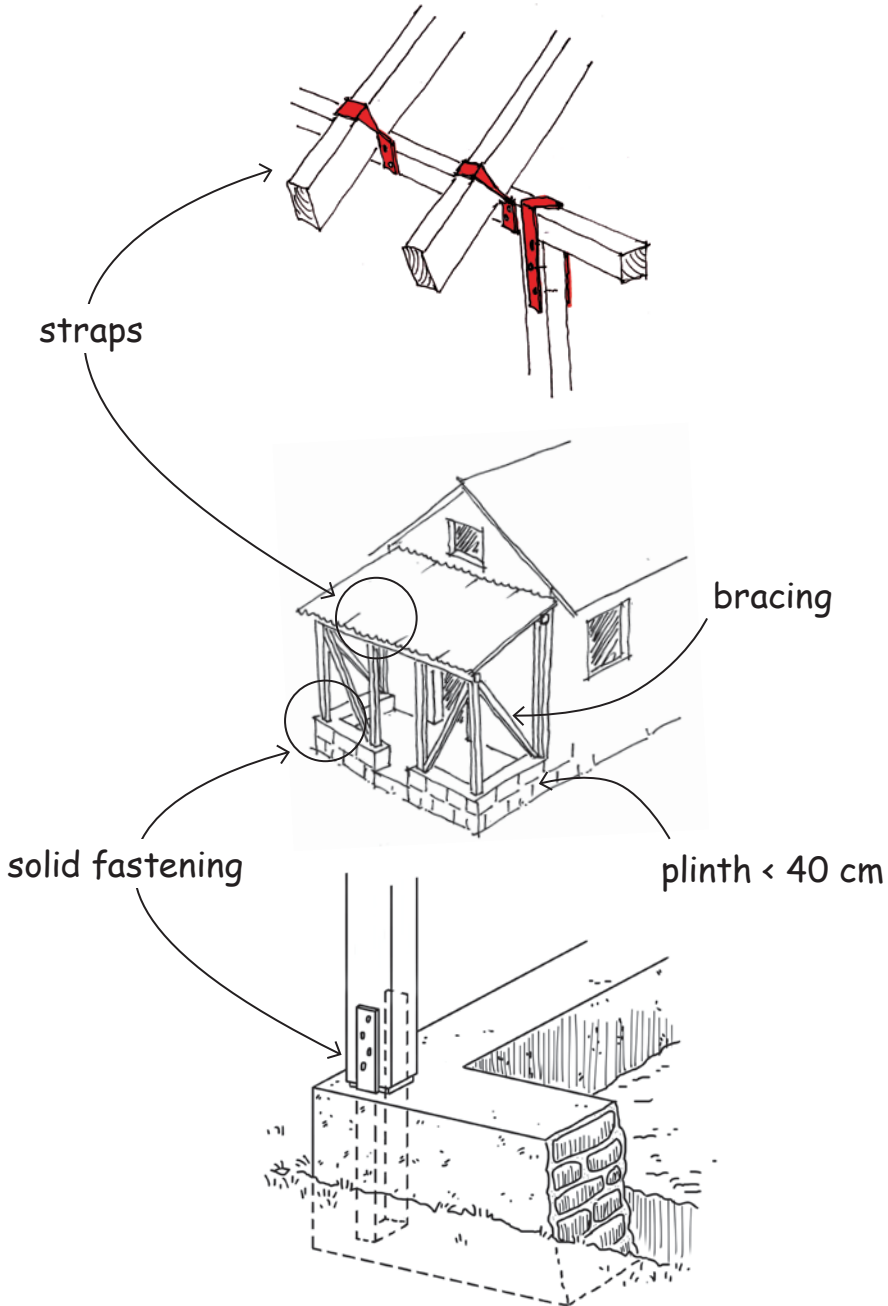

Fastening of the roof structure

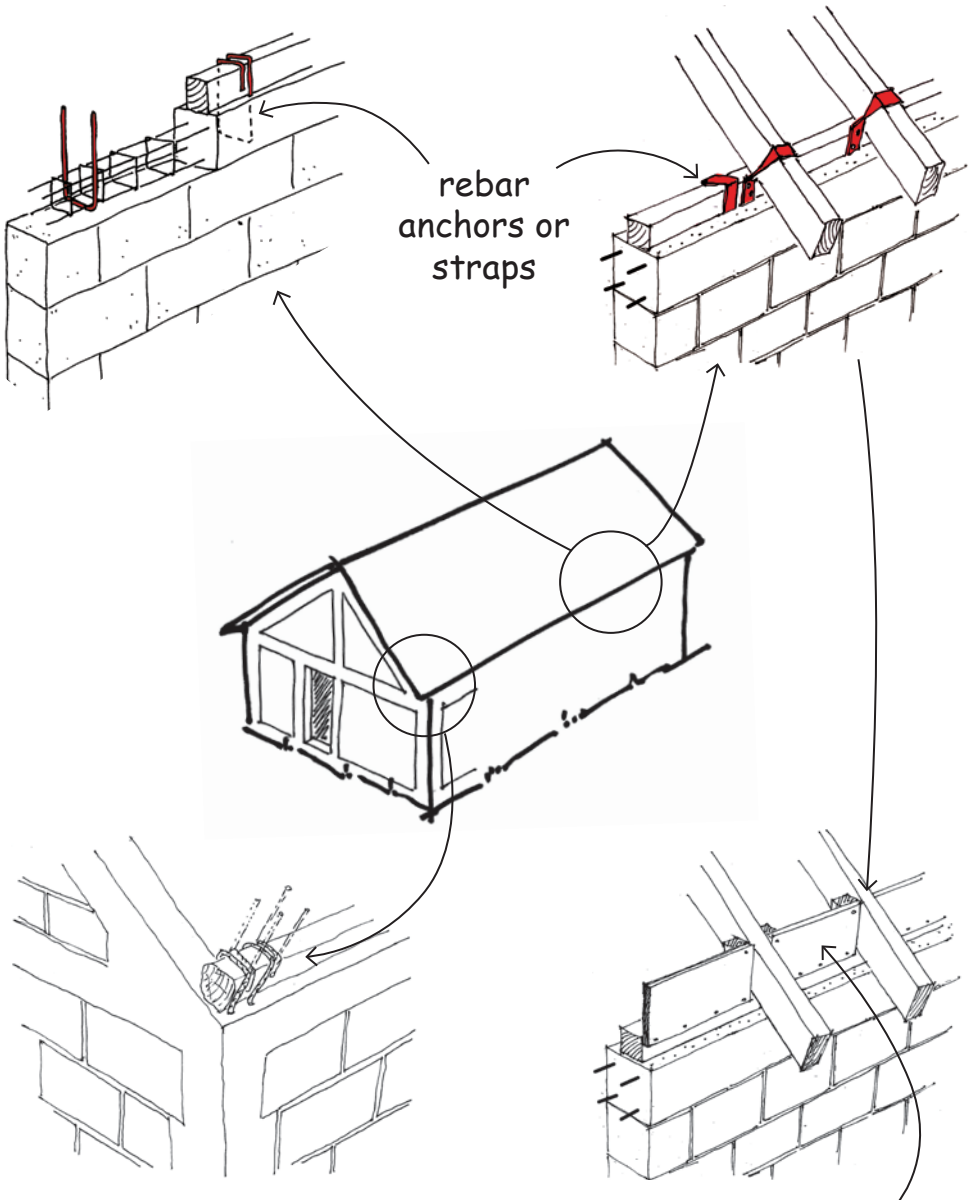

Solidly fasten the anchors or straps to the wood framing.

Close the spaces between trusses with a plank or a screen to deter insects.

Bracing

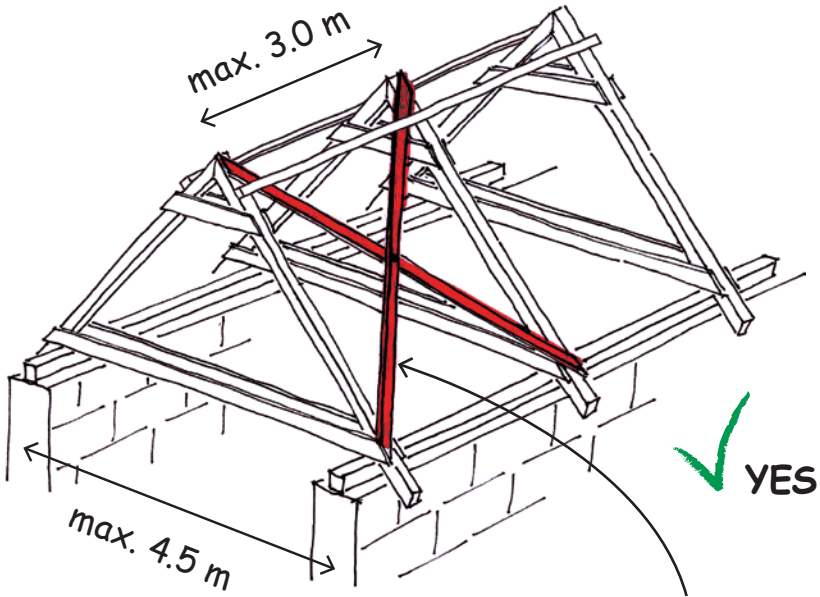

Bracing:
wood planks nailed
to the trusses

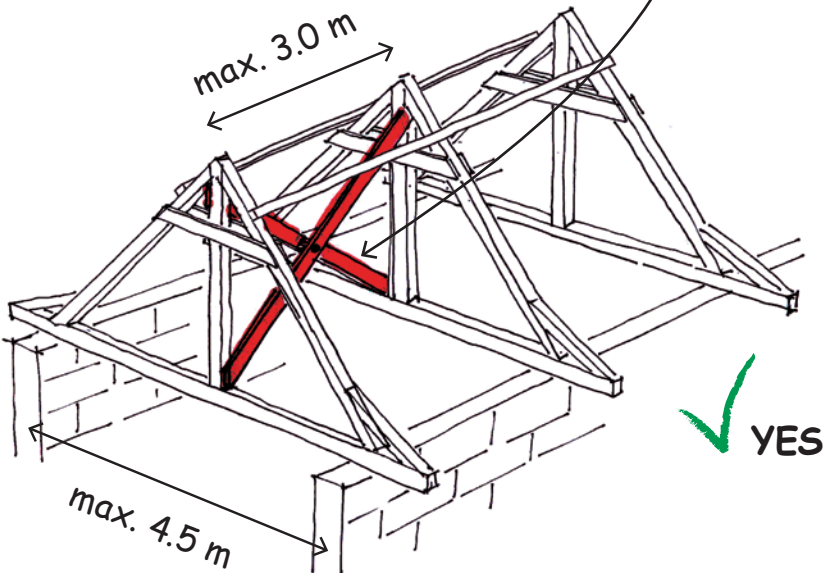

14. RETAINING WALLS

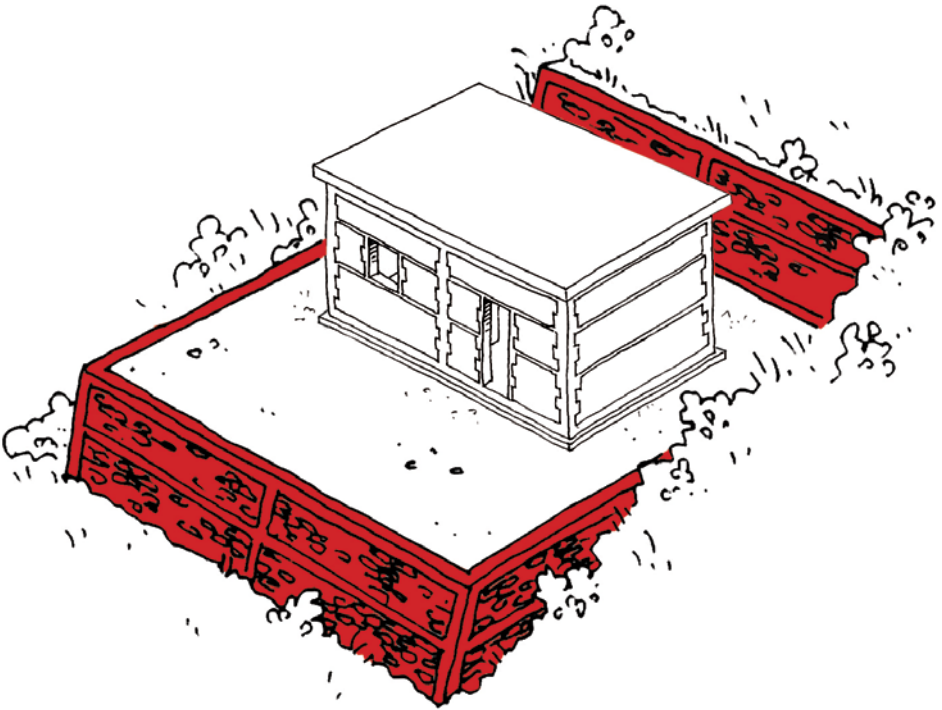

Where to build with retaining walls

A retaining wall is not a house wall. Water will and must leak through it.

A retaining wall is meant to hold back the ground.

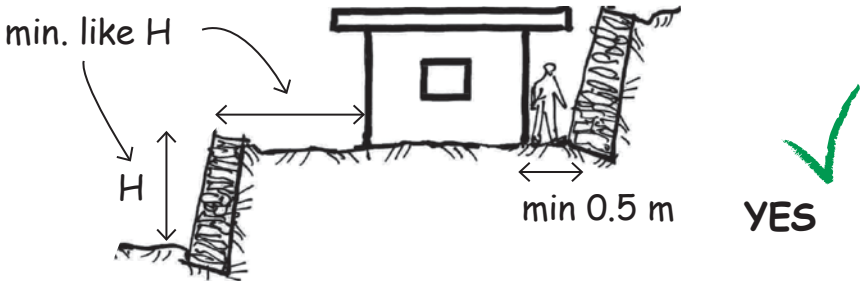

Don't build your house too close to a retaining wall.



Don't build your house on top of a retaining wall.

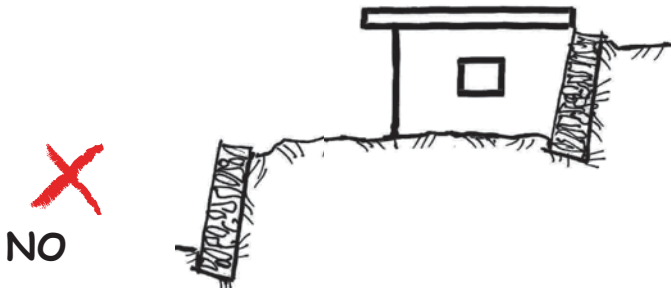

Don't build your house against a retaining wall.

Rule 1 - Wall footing

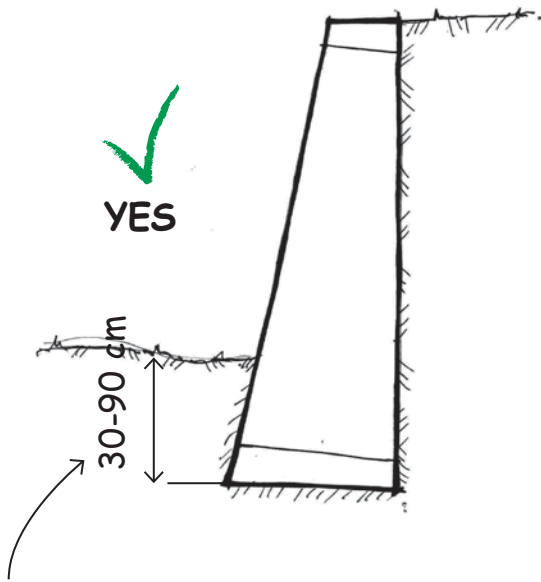

Height from bottom of wall to firm soil

- | | |
|----------------|----------|
| - hard soil: | 30 cm |
| - rammed soil: | 30-60 cm |
| - soft soil: | 60-90 cm |

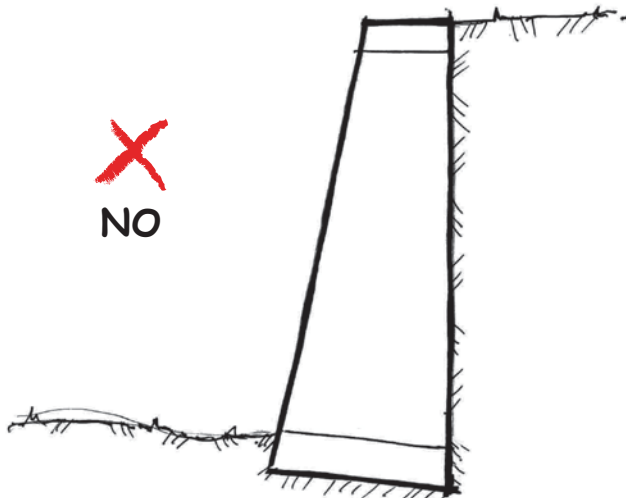

Rule 2 - Slope of the wall (5:1)

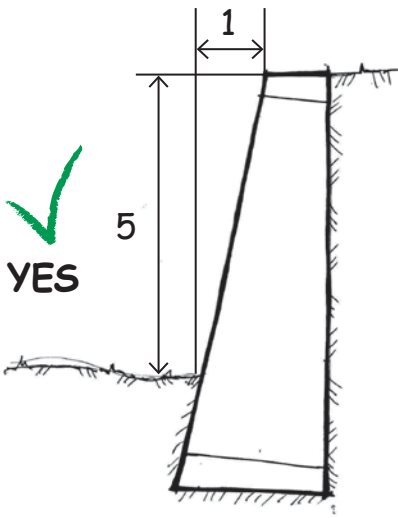
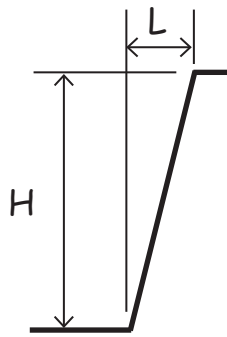

Chart
H : L = 5 : 1



H	L
100	20
125	25
150	30
175	35
200	40
250	50

Slope 1:5

Every time you go up 5 cm, move back 1 cm
Every time you go up 1 meter, move back 20 cm

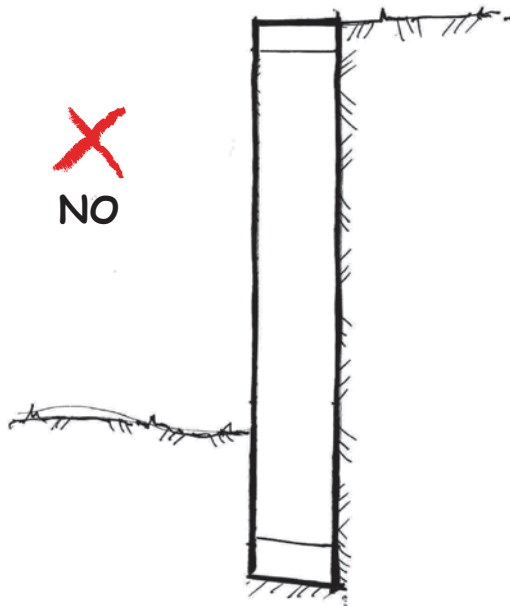

Rule 3 - Dimensions of the wall

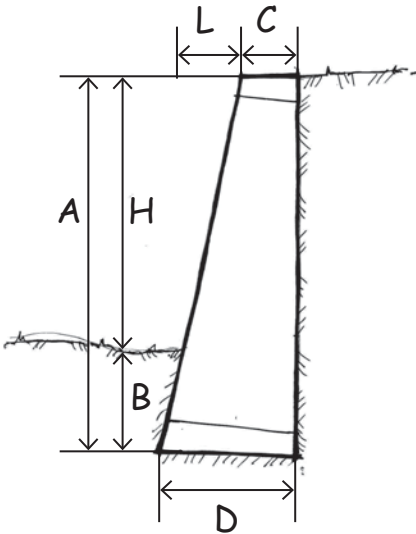

Height above ground (H):
 $H \text{ max} = 2.50 \text{ m}$

Top (C): min 50cm
 50 cm: $H \leq 150 \text{ cm}$
 55 cm: $H > 150 < 250 \text{ cm}$
 60 cm: $H \geq 250 \text{ cm}$

Total height (A):
 $A = H + B$
 (-> $B = 30\text{-}80 \text{ cm}$)

Wall base width (D) calculation:

The base of the wall (D) equals the total height (A) divided by 5, plus the top's width (C):

$$D = A/5 + C$$

Table

H	C	B	A	D
100	50	30-80	130-180	75-85
125	50	30-80	155-205	80-90
150	50	30-80	180-230	85-95
175	55	30-80	205-255	95-100
200	55	30-80	230-280	100-110
250	60	30-80	280-330	115-125

Rule 4 - Placing the stones

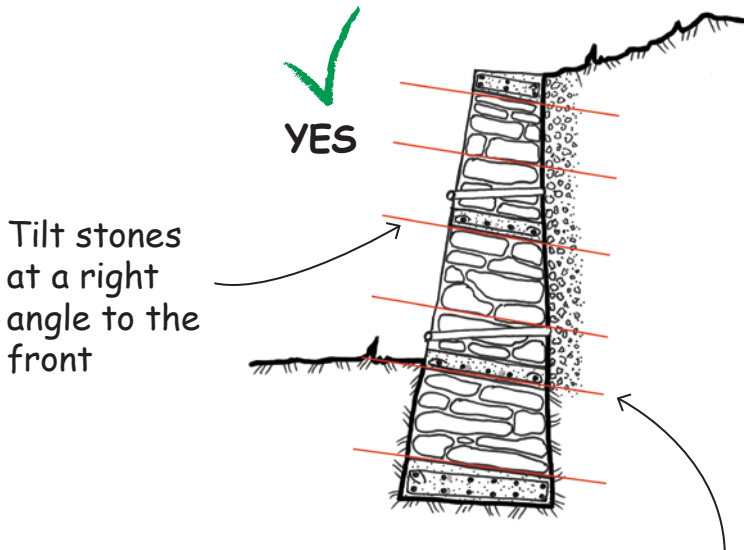

Place the stones on their flat faces and tilt them towards the back.

Place the stones at right angles to the wall's external face.

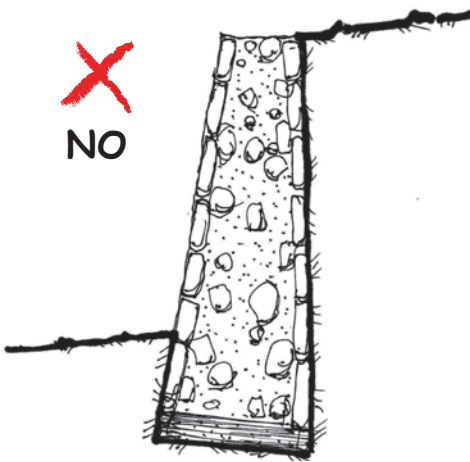

Don't place the stones vertically.

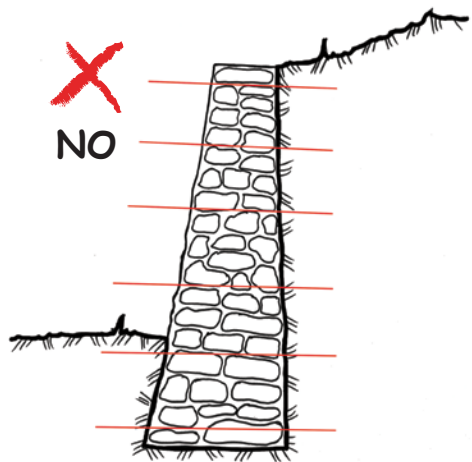

Don't place the stones horizontally.

http://www.developmentbookshelf.com/doi/book/10.3362/9781780449883 - Monday, January 22, 2018 6:25:39 AM - IP Address: 193.5.216.100

Rule 5 - Through-stones (or bands)

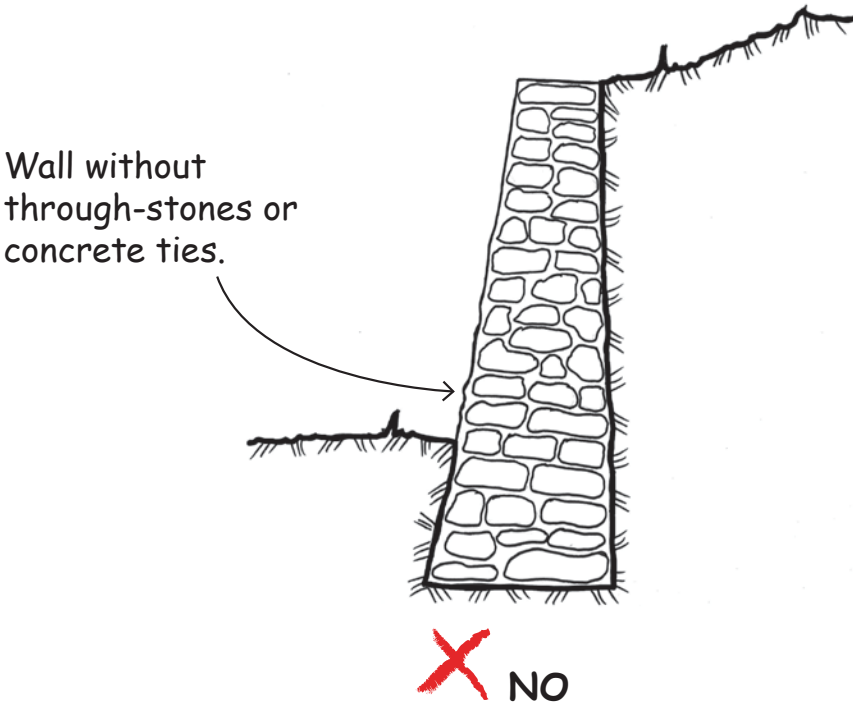
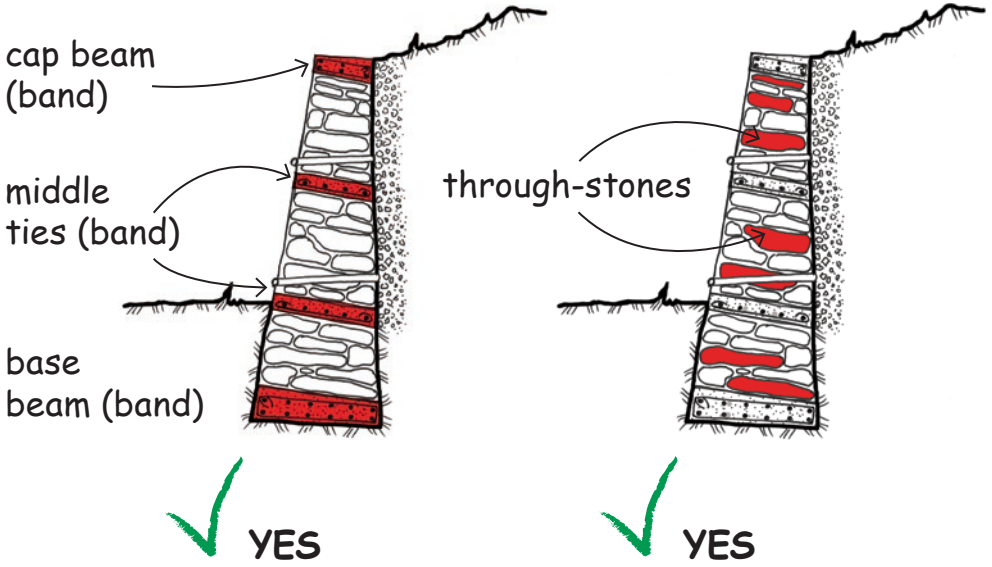

http://www.developmentbookshelf.com/doi/book/10.3362/9781780449883 - Monday, January 22, 2018 6:25:39 AM - IP Address: 193.5.216.100

Rule 6 - Drainage

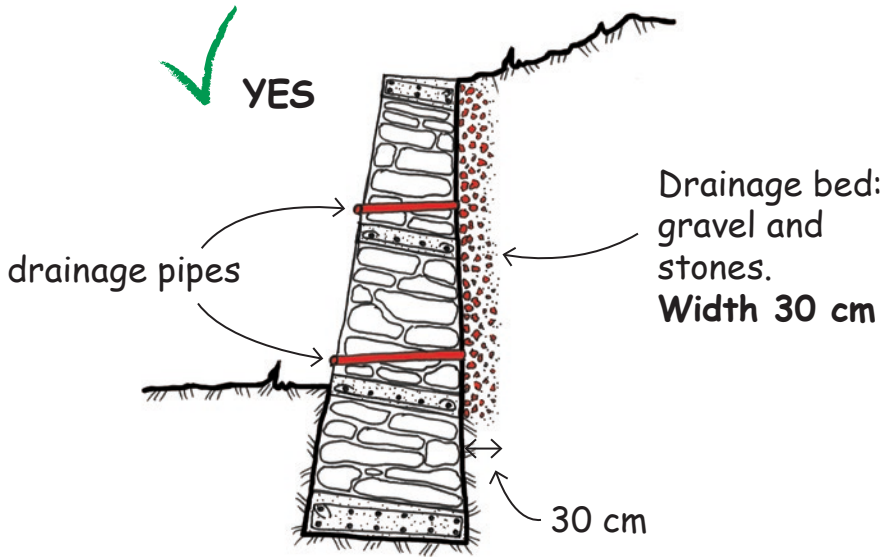

Place a drainage pipe every 1.50 m (vertically and horizontally)

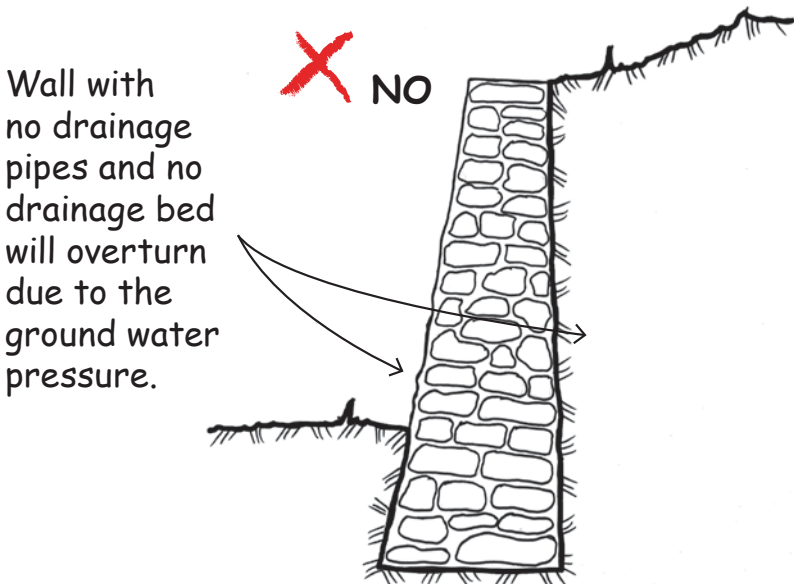

Retaining wall - Confining elements

These recommendations are for building a house on retaining walls: **Do it only if there is no other option.**

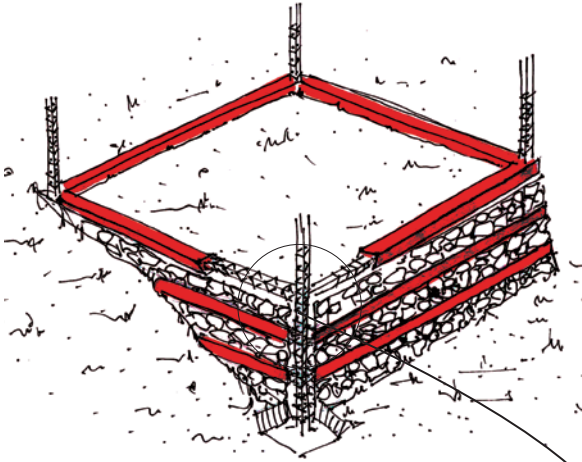

Tie-columns

Every 3 - 4.50 m

Tie-beams

Must go all around the foundation.

Every 1 m height add one at the top.

**If possible:
avoid building
the house on a
retaining wall!**

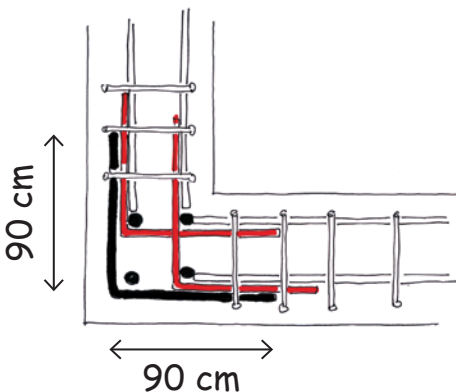
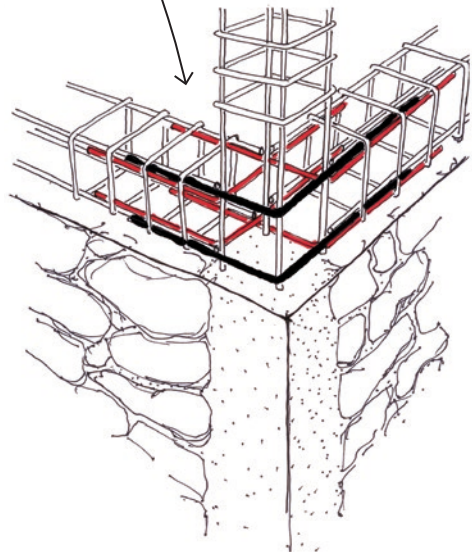

Gabion retaining walls 1

Gabion walls consist of baskets woven with galvanised wire and carefully filled with stones.

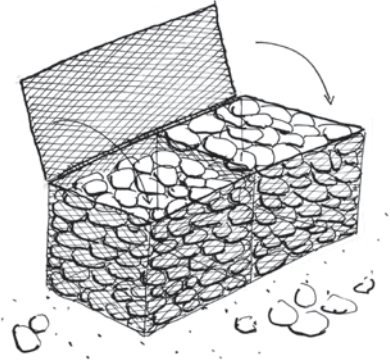

Stones must be placed carefully by hand. Don't just throw them in.

There are several ways to stack the baskets. All are equally acceptable.

Method 1: in steps

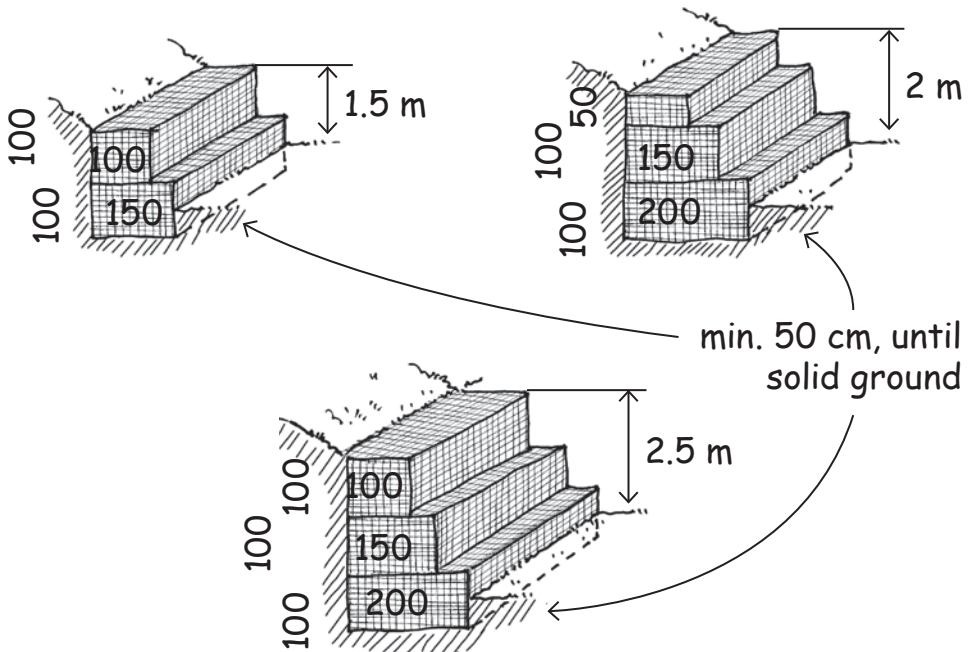

Gabion retaining walls 2

**Method 2:
with a vertical face**

**Method 3:
with an inclined face**

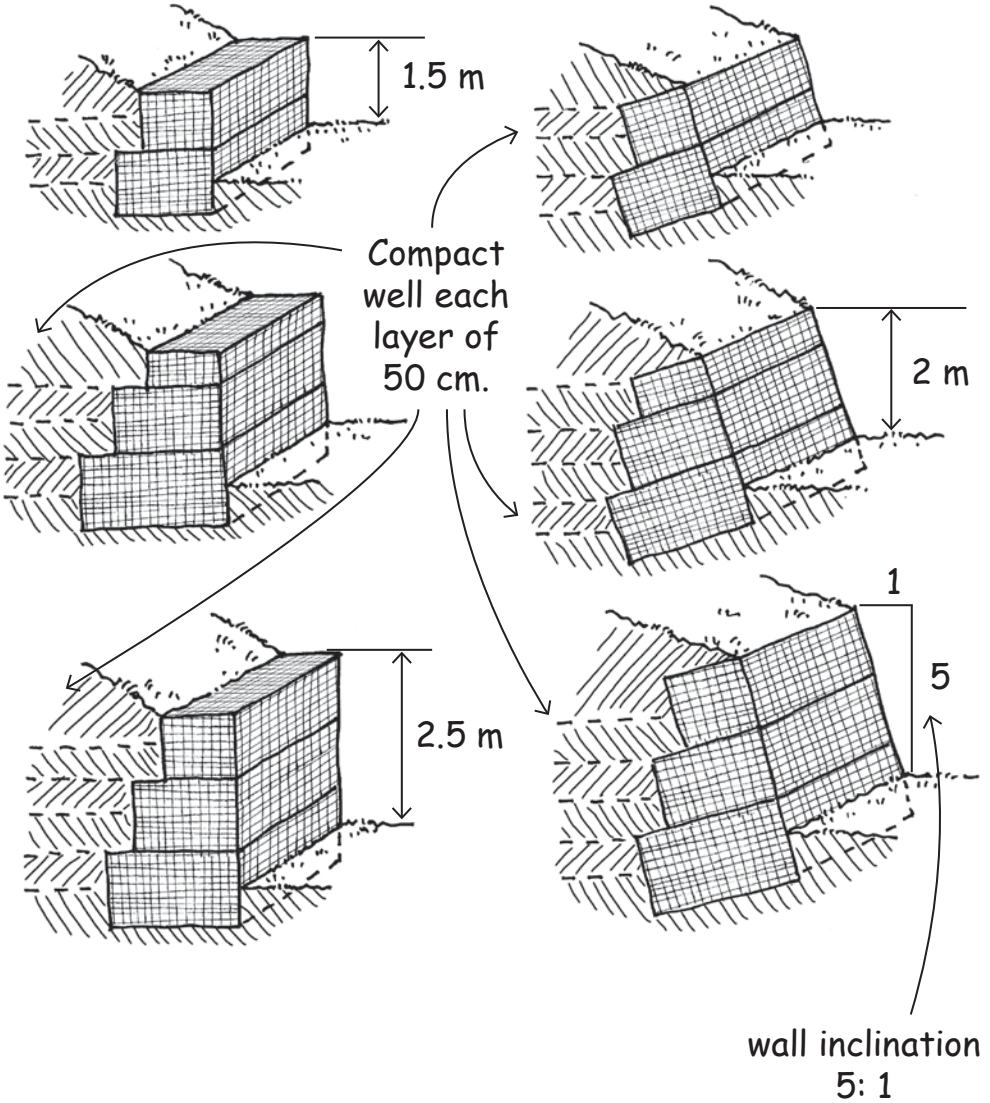

15. CONSTRUCTION DRAWINGS

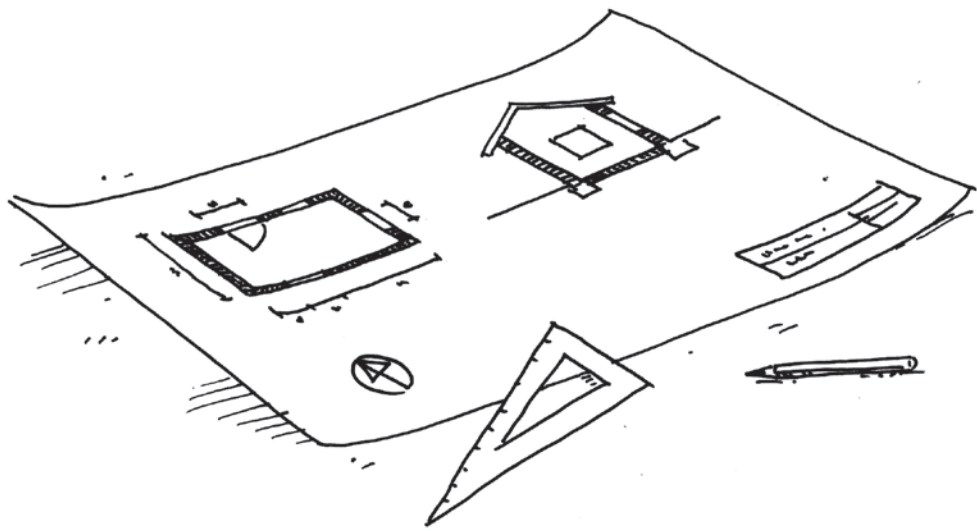

Reading plans

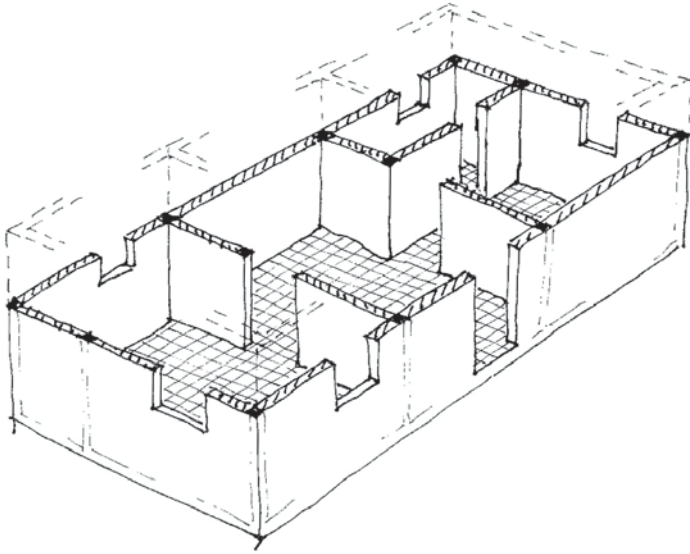

To draw a plan, imagine cutting the house at the window height.

Door symbol:
indicates the direction
of opening of the door.

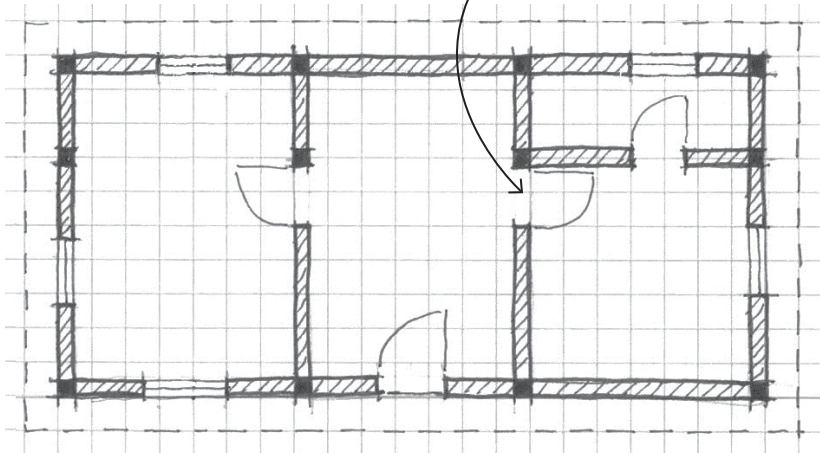

House plan (seen from the top).

Reading sections

If you vertically cut the house on this line ...

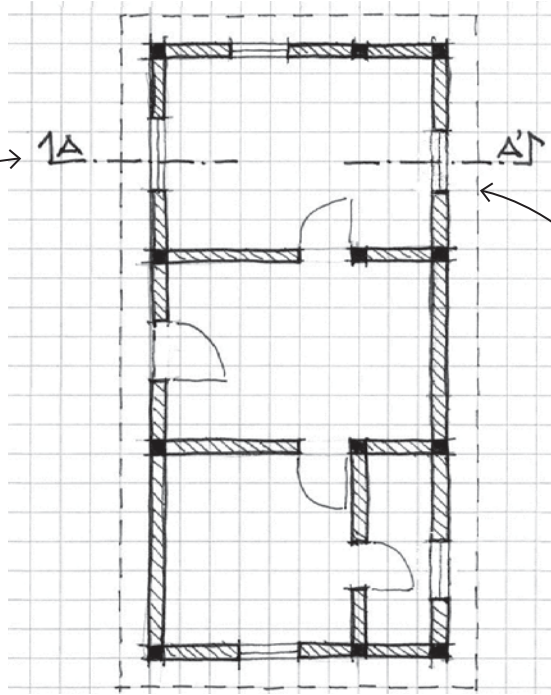

same window

... this is what you will see

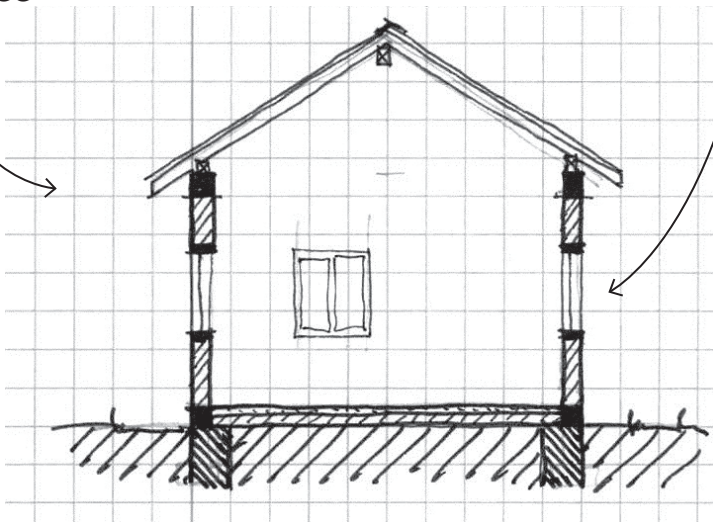

Plan dimensions

The sum of all partial dimensions must result in the total dimension.

Partial dimensions

Total dimension

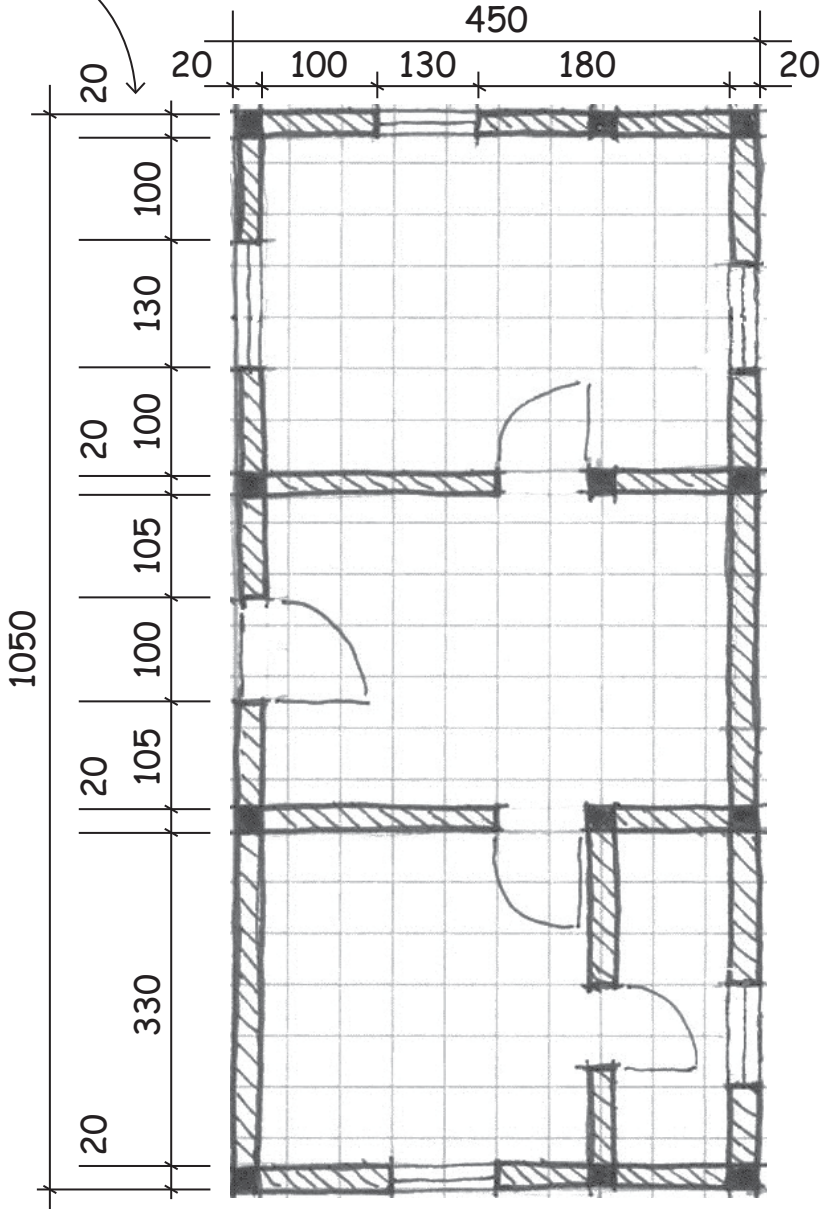

Section dimensions

Partial dimensions

Partial dimensions

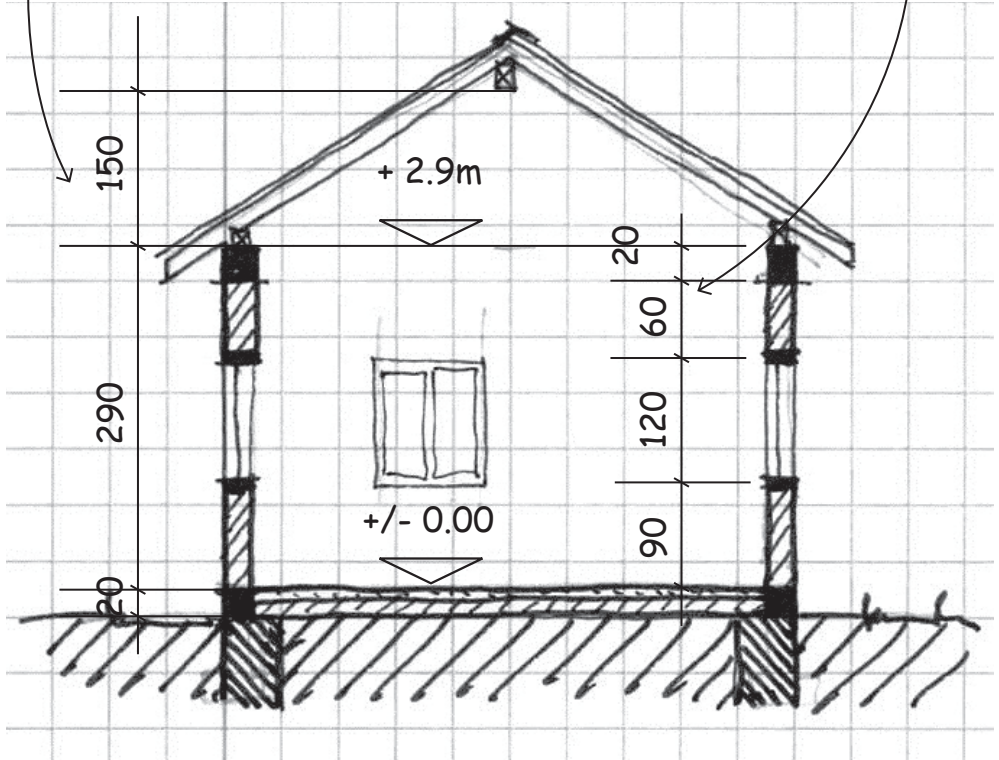

How to build safer houses with confined masonry

Low-rise buildings in earthquake-prone areas in many parts of the world are often constructed by self-taught masons and contractors. *How to build safer houses with confined masonry: a guide for masons* is an essential 'how to' handbook bringing together a collected knowledge of earthquake-resistant construction techniques indispensable for masons and construction workers.

The guide focuses on 'confined masonry', a construction system consisting of masonry walls (built first) and horizontal and vertical reinforced concrete elements (poured in subsequently) that confine the masonry wall panels on all four sides. This method has been developed by practitioners rather than engineers and responds well to the technical and financial capacities of self-builders.

This easy-to-read pocket guide combines detailed illustrations and images with clear instructions to address construction issues. The guide acts as an ideal companion for masons, construction workers, contractors, technicians, architects and students of architecture and civil engineering completing practical training on building sites.

Nadia Carlevaro and **Guillaume Roux-Fouillet** are architects and the founders of mobilstudio. They have 10 years of humanitarian experience with the Swiss Agency for Development and Cooperation (SDC) and other organisations in designing and training on earthquake- and cyclone-resilient buildings in Myanmar, Haiti, the Philippines, Nepal and Ecuador. **Tom Schacher** is an architect with 20 years of humanitarian experience as a technical expert with SDC in Kenya, Rwanda, Turkey, Ethiopia, Iran, Pakistan, Haiti and Ecuador. He has developed manuals and training materials for construction workers on locally appropriate earthquake-resistant construction techniques.

'This book warrants wide international dissemination to educate masons and others in the safest way to build houses using the most commonly available construction materials, reinforced concrete and masonry.'

Andrew Charleson, Associate Professor in Building Structures, Victoria University of Wellington



ISBN 978-1-85339-989-3

