

307/1

# HOW TO BUILD A HOUSE ....USING SELF-HELP HOUSING TECHNIQUES

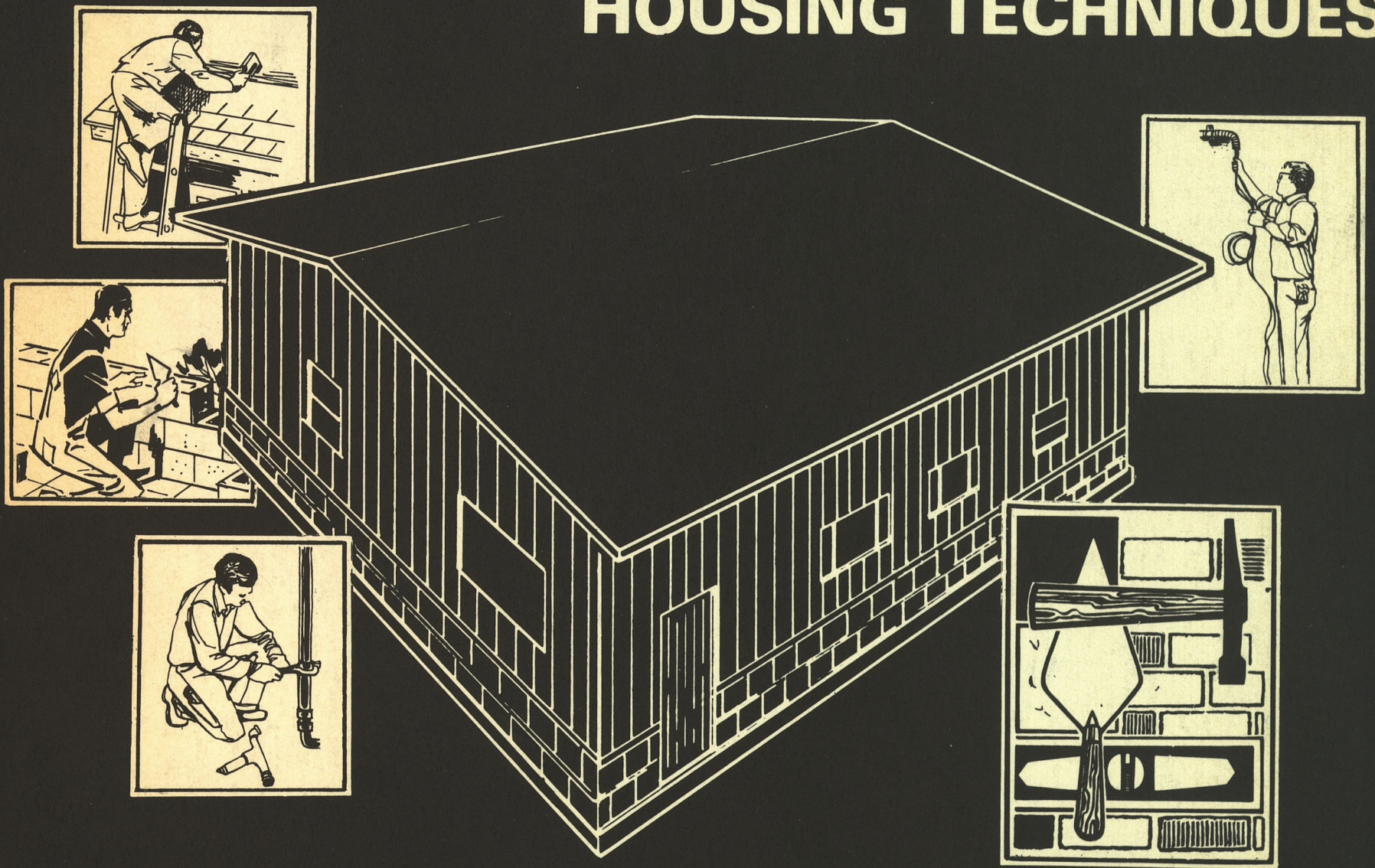

Agency for International Development  
Washington, D.C. 20523

COMO FABRICAR UNA  
CASA... USANDO TECNICA  
AYUDA PROPIA

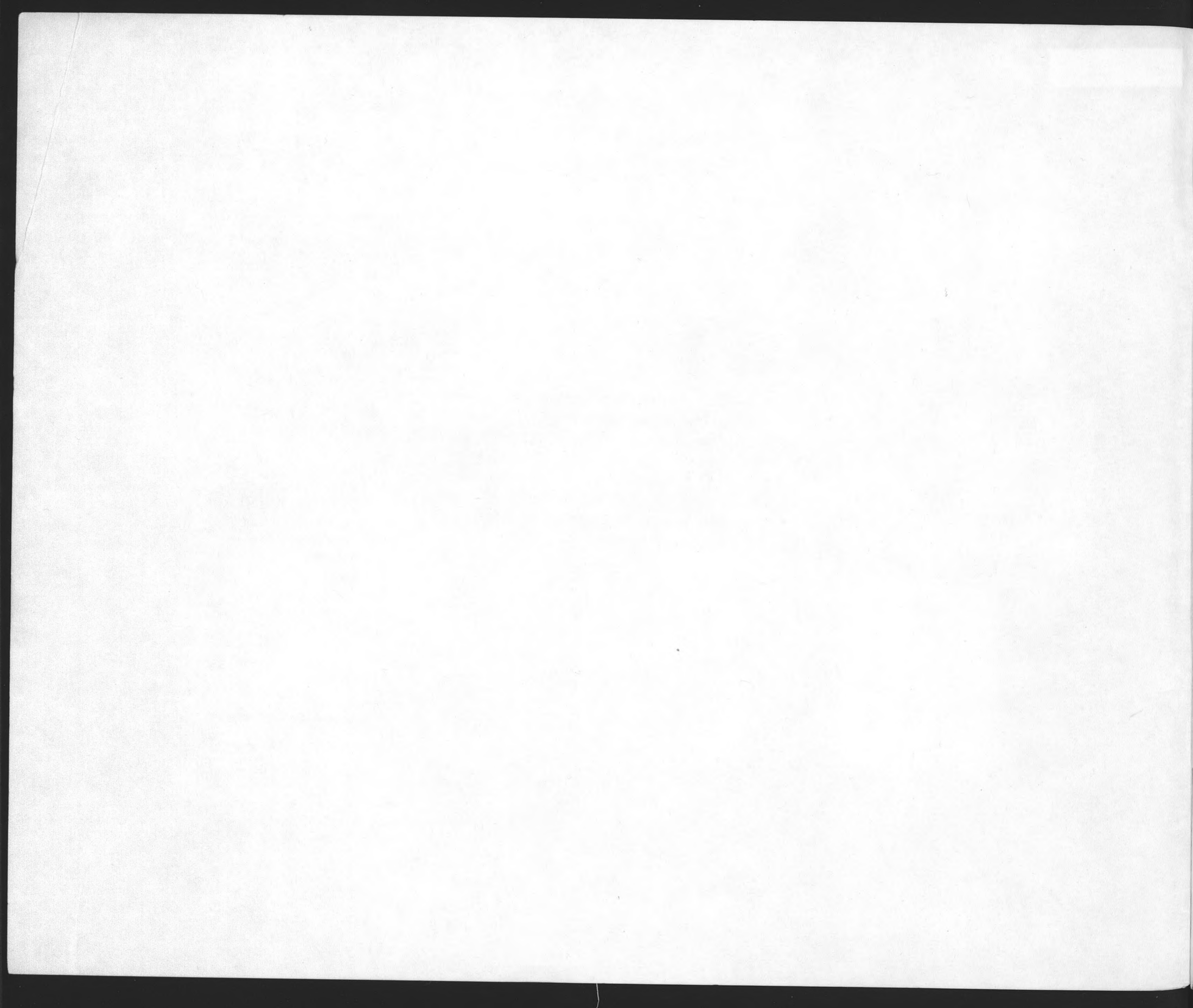

The Office of International Affairs, Department of Housing and Urban Development, has published this manual on self-help housing in the interests of the dissemination of information and knowledge of interest to U.S. domestic and other low income family needs. The techniques presented are not necessarily representative of construction in any given geographical area.

MAY 1974

You can build your own house!

This manual is designed as a graphic means of demonstrating the basic methods and techniques used in building a home, whether it be a one room cabin or a more complicated dwelling with an electric, plumbing and sewage system. It has been conceived as a basic technology handbook for use by either individuals or groups of individuals who have the goal of building, or adding to, a home of their own, and for those involved in self-help home building or home improvement projects.

Much of the graphics material has been reproduced from a manual on the same subject produced by the Inter-American Institute for Housing located in Bogota, Columbia, in collaboration with the National University of Columbia, and the Institute for Territorial Credit, the Colombian Government agency for the development of low cost housing.

**! Usted puede fabricar su propia casa!**

Este manual ha sido diseñado con el objeto de demostrar en forma grafica, los metodos y tecnicas basicos que se utilizan en construir una casa; sea esta del tipo de cabana de un cuarto o de un tipo de vivienda mas complicado - con electricidad, instalacion de canerias y sistema de alcantarillado. Esta manual ha sido concebido como un texto basico y tecnologico para ser utilizado ya sea individualmente o por grupos de individuos cuyo objetivo se encamine a construir, o agregar en parte, su propia casa, y para aquellos involucrados en construcciones de casa - por su propia ayuda - o proyectos de mejoras de viviendas.

Gran parte del material grafico ha sido reproducido de un manual que trata sobre la misma materia presentado por el Instituto Inter-Americano de Viviendas ubicado en Bogota, Columbia, en colaboracion con la Universidad Nacional de Columbia, el Instituto de Credito Territorial, y por la agencia de desarrollo de viviendas de bajo costo del Gobierno de Columbia.

TABLE OF CONTENTS  
EL CONTENIDO

	Page Página	
<b>Shelter Types</b>	6	<b>Tipos de Casas</b>
Units for Rainy Climates	6	Casas en Clima Húmedo
Units on Sloped Terrain	6	Casas en Desnivel
Units for Hot Climates	6	Casas en Clima Caliente
Units Designed for Temperate Climates	7	Casas en Clima Templado
Units Designed for Hot and Humid Climates	7	Casas en Clima Caliente y Húmedo
<b>Parts of a House</b>	8	<b>Los Cuartos de una Casa</b>
Kitchen	8	La Cocina
Dining Room	8	El Comedor
Living Room	8	La Estancia
Bedroom	9	Las Camas
Bathroom	9	El Baño
<b>The Drawing</b>	10	<b>El Plan</b>
<b>Laying Out A Building</b>	11	<b>Contorno de la Construcción</b>
Squaring the Layout	11	Localización de la Casa
Layout-Levelling	12	Contorno y Nivelación
Staking Out the House	14	Apuntando y Localizando la Casa
<b>The Foundation</b>	16	<b>La Fundación</b>
Materials and Construction Methods	16	Materiales y Métodos
Equipment and Tools	16	Utensilios
<b>The Walls</b>	18	<b>Los Muros</b>
Brick or Cement Block Walls	19	Muros de Ladrillos
Village Brick Works	20	Para Hacer Ladrillos
Adobe Walls	22	Muros de Adobe
Making Adobe Bricks	23	Ladrillos de Adobe
Stone Walls	24	Muros de Piedra
Using Plaster to Finish Walls	25	Aplanado de Yeso
Windows and Doors	26	Ventanas y Puertas
Thresholds and Window Sills	28	Sardineles y Repisones

TABLE OF CONTENTS  
EL CONTENIDO

	Page Página	
<b>The Floors</b>	30	<b>Los Pisos</b>
Concrete	30	Cimiento
Stone Floor	31	Piso de Piedra
Flagstone Floor	31	Piso de Piedra Laja
Wood Floor	32	Piso de Madera
<b>The Roof</b>	33	<b>El Techo</b>
Clay Tile Roof	34	Techo con Tojas de Barro
Aluminum Roof	35	Techo de Aluminio
Asbestos Roof	36	Techo de Asbestos
Thatched Roof	38	Techo de Zacate
<b>Water Supply Systems</b>	39	<b>Agua Para Usos Domesticos</b>
Water Purifications	40	Filtros Domésticos
House Plumbing	40	Instalación y Drenaje
<b>Sewerage Disposal Systems</b>	43	<b>Alcantarillado-Letrinas</b>
Septic Tank System	44	Sistema de Alcantarillado con Tanque Séptico
Household Septic Tanks	44	Tanque Séptico para Uso Doméstico
Outhouses and Latrines	46	Letrinas
<b>Electrical Systems</b>	47	<b>Sistemas Eléctricos</b>
Wiring Diagrams	47	Instalación de Alambres
House Wiring Layout	48	Sistema de Alambres para una Casa
Electrical Components	50	Componentes Eléctricos

For sale by the Superintendent of Documents, U.S. Government Printing Office,  
Washington, D.C. 20402 - Price    cents domestic postpaid, or    cents GPO Bookstore  
Stock Number 2300-00224

# Shelter Types

## Tipos de Casas

Units for Rainy Climates

Casas para Clima Húmedo

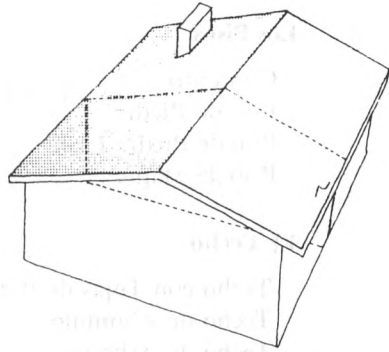

Units on Sloped Terrain

Casas en Desnivel

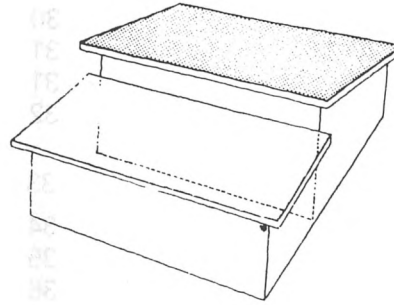

Units for Hot Climates

Casas en Clima Caliente

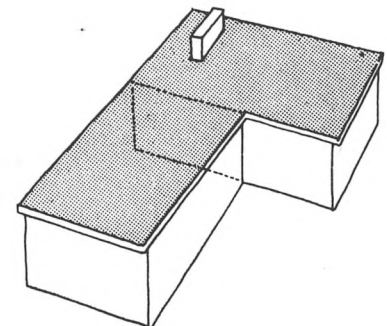
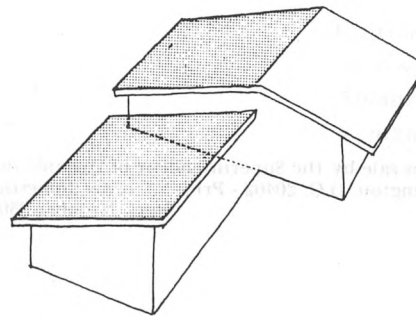
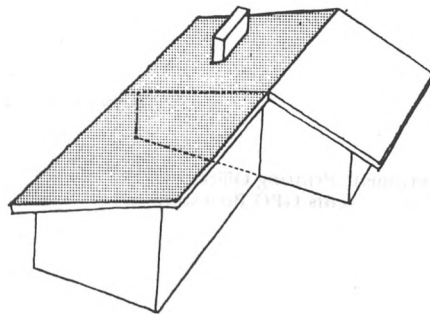
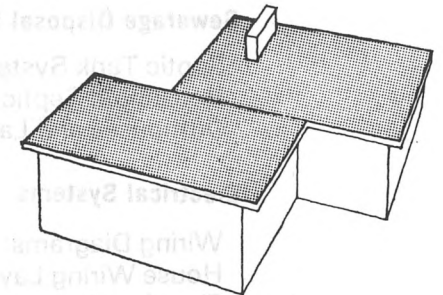
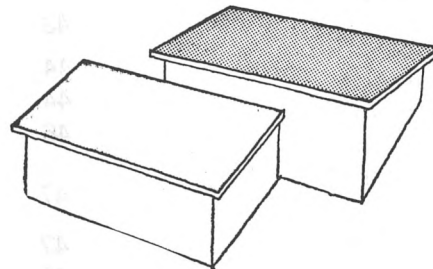
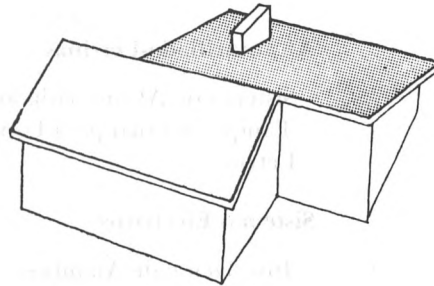
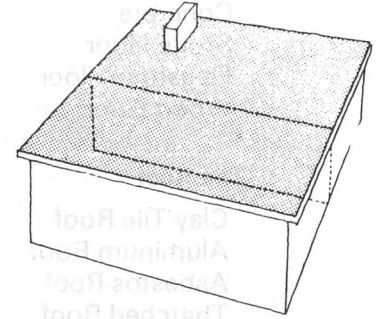

Part of a house  
for temperate zones

Units for Temperate Zones  
Casas en Clima Templado

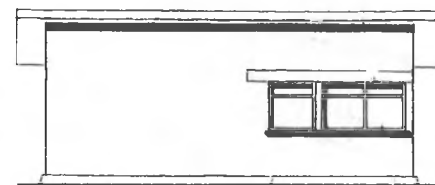
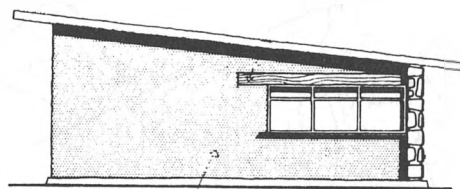
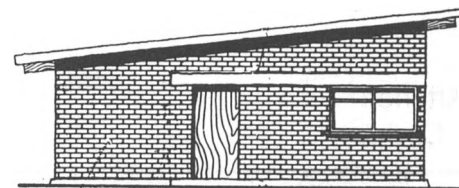
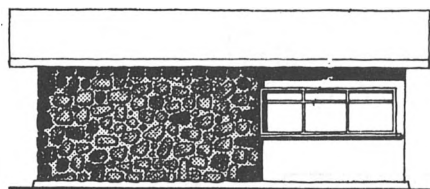

Units for Hot, Humid Zones  
Casas en Clima Caliente Húmedo

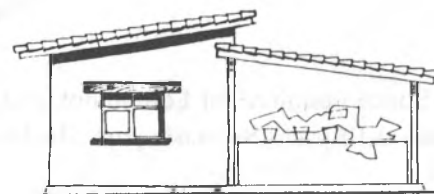
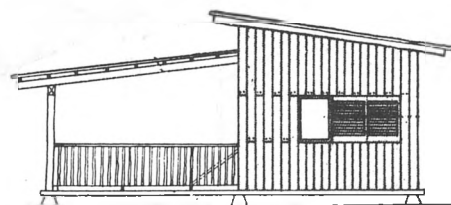
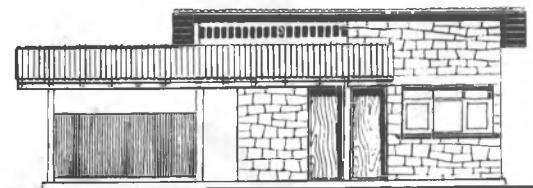
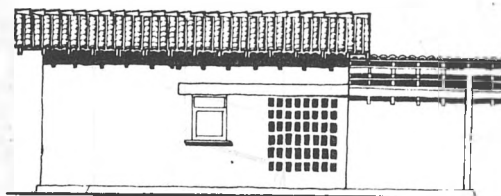

# Parts of a House

## Los Cuartos de una Casa

Kitchen  
Cocina



Dining Room  
Comedor

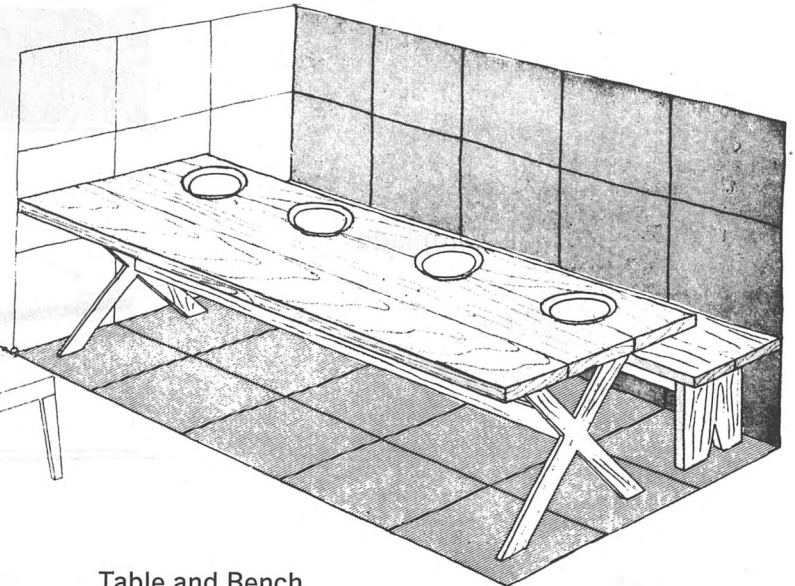
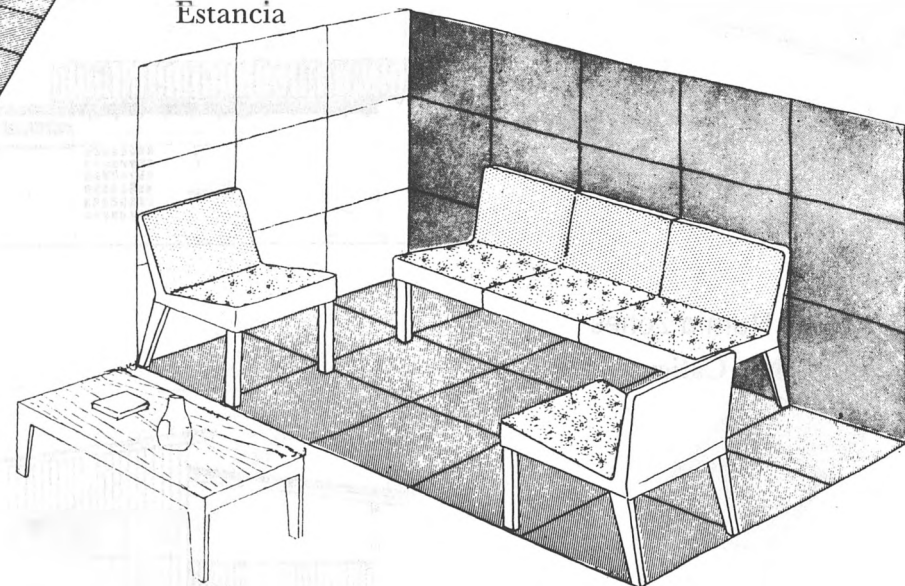

Table and Bench  
Mesa, Banco-Silla

Living Room  
Estancia



Couch and Table  
Sofá y Mesa

Shows Space Required for Equipment and Circulation  
Muestra del Espacio Necesario para Muebles y Circulación

Bedroom  
Las Camas

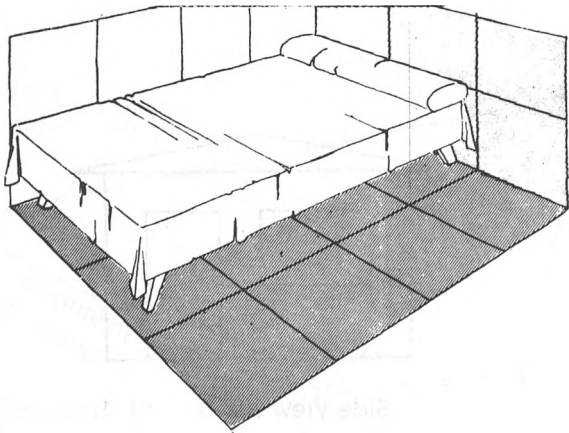

Single Bed Space  
Espacio para Cama Individual

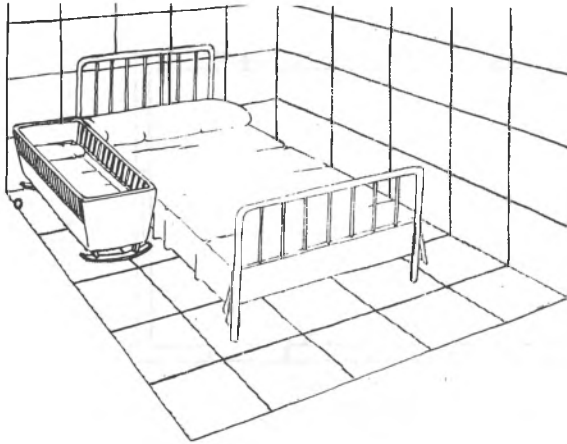

Bed with Crib  
Espacio para Cama Mediana y Cuna

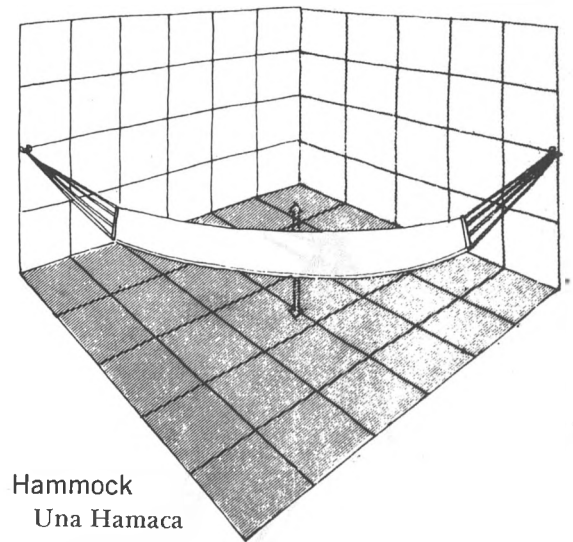

Hammock  
Una Hamaca

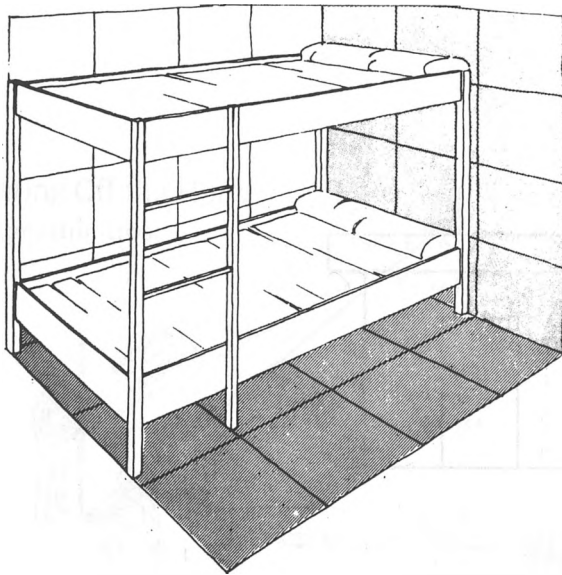

Bunks  
Espacio para Dos Literas



Bathroom  
El Baño

# The Drawing El Plan

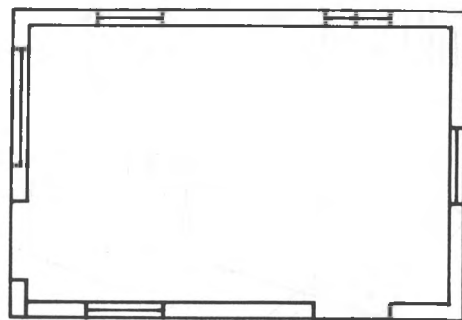
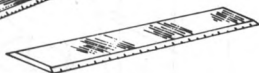
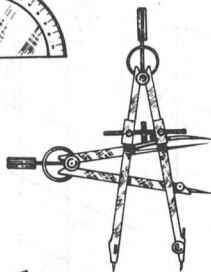
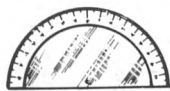
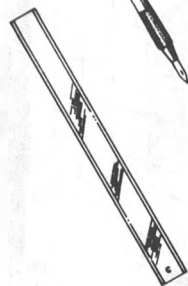

View from Above  
Vista de Arriba

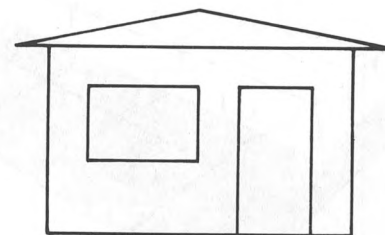

Side View (Left)  
Vista de Izquierda

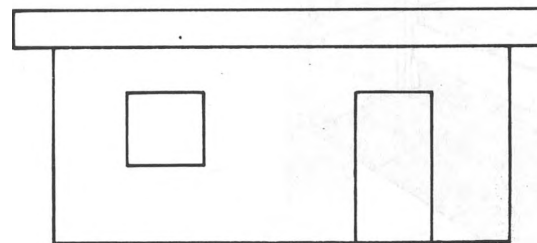

Front View  
Vista de Enfrente

# Laying Out a Building

## Contorno de la Construcción

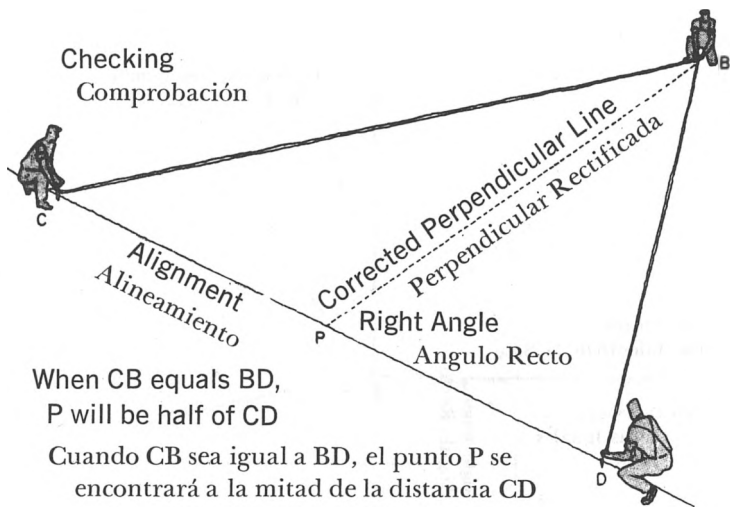

# Squaring the Layout

## Localización de la Casa

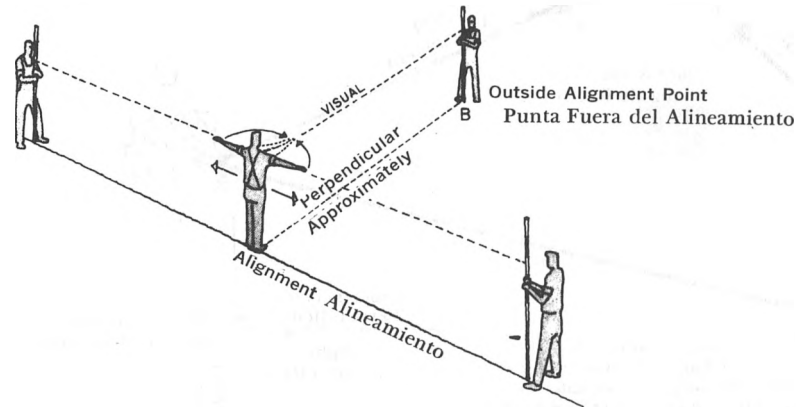

# Squaring Off the House

## Alineamientos

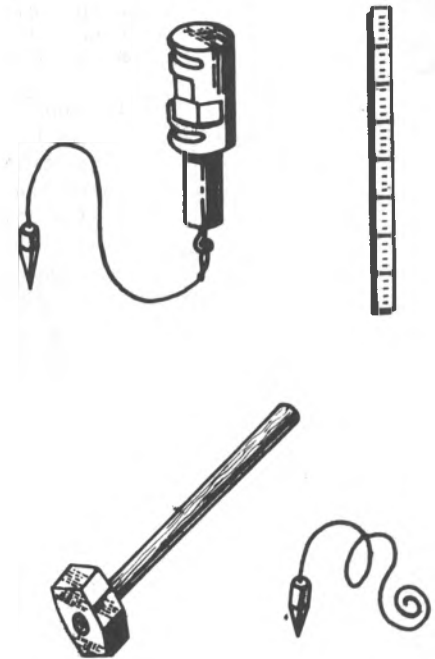
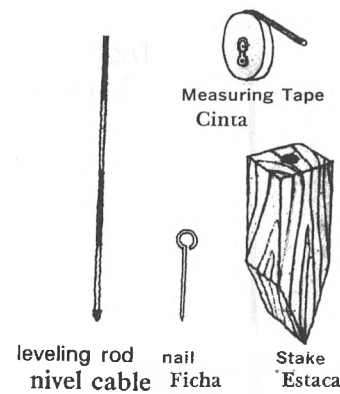
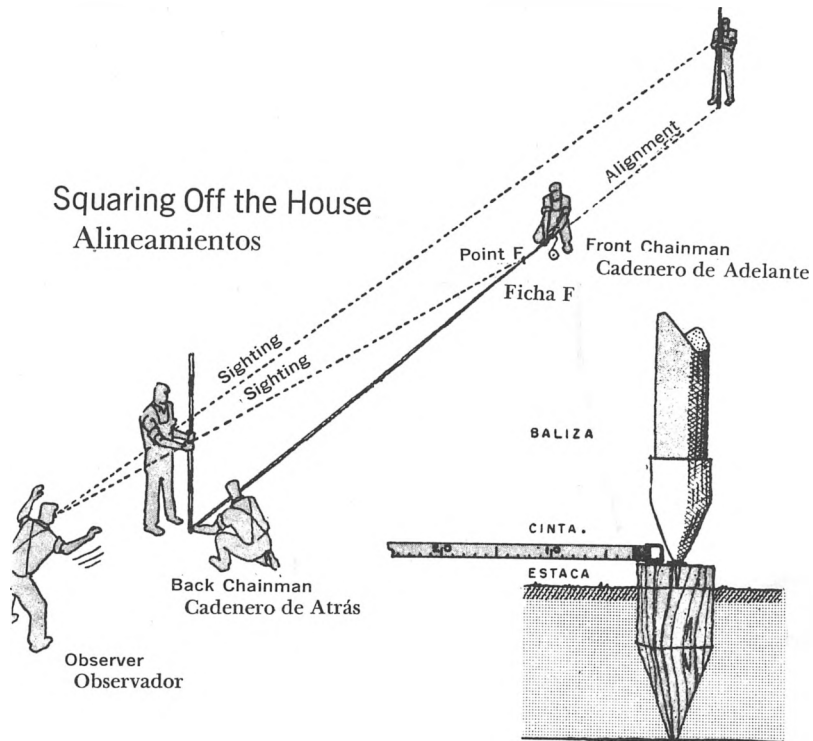

Layout and Levelling  
 Contorno y Nivelación

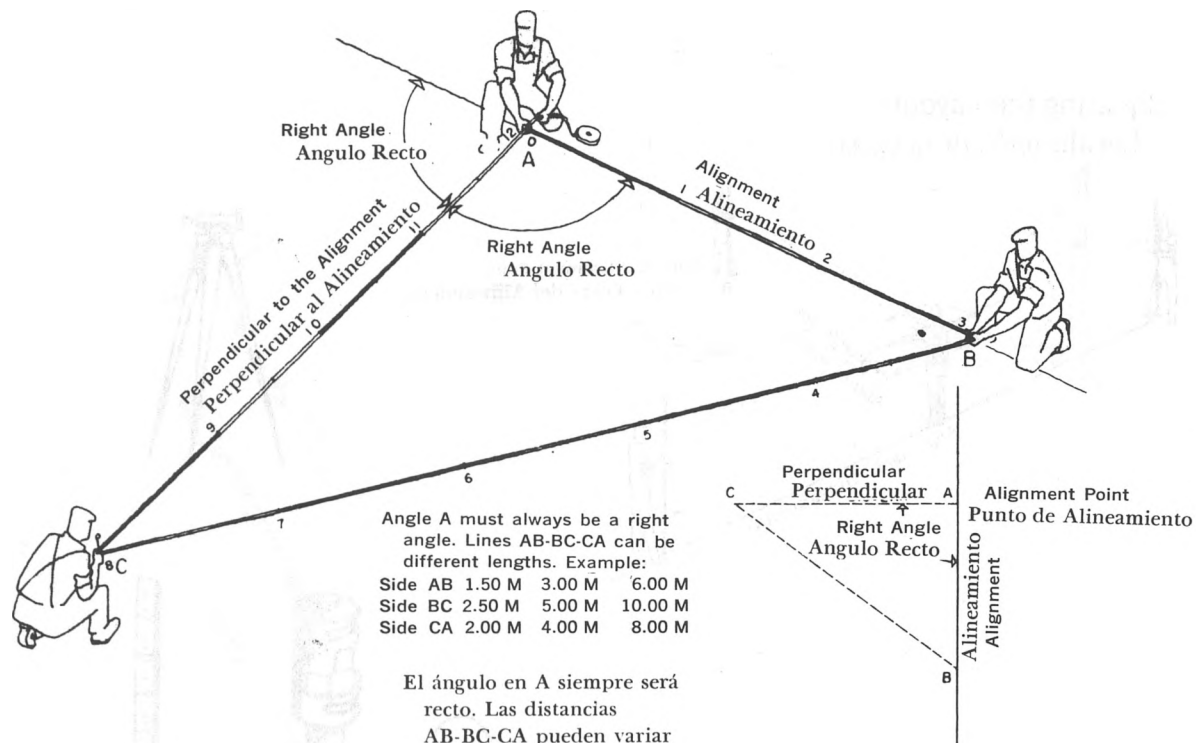

Angle A must always be a right angle. Lines AB-BC-CA can be different lengths. Example:

Side AB	1.50 M	3.00 M	6.00 M
Side BC	2.50 M	5.00 M	10.00 M
Side CA	2.00 M	4.00 M	8.00 M

El ángulo en A siempre será recto. Las distancias AB-BC-CA pueden variar según convenga. Ejemplo:

Lado AB	1.50 M	3.00 M	6.00 M
Lado BC	2.50 M	5.00 M	10.00 M
Lado CA	2.00 M	4.00 M	8.00 M

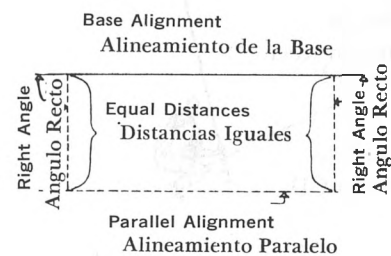

Tools  
Utensilios

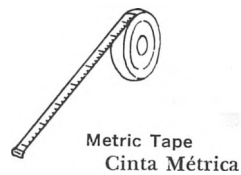

# Establishing a level between two points

## Nivelación entre dos puntos

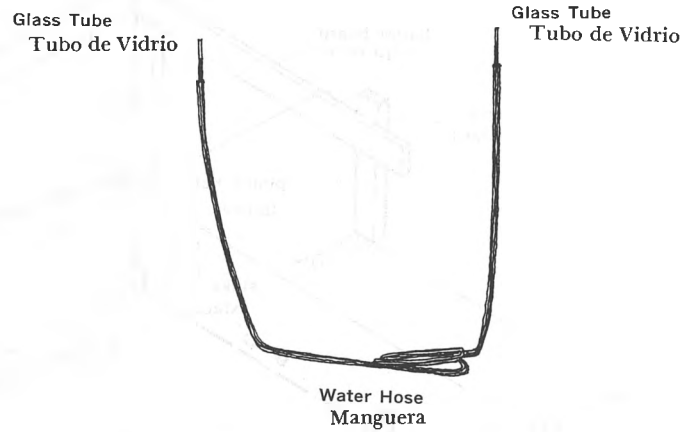
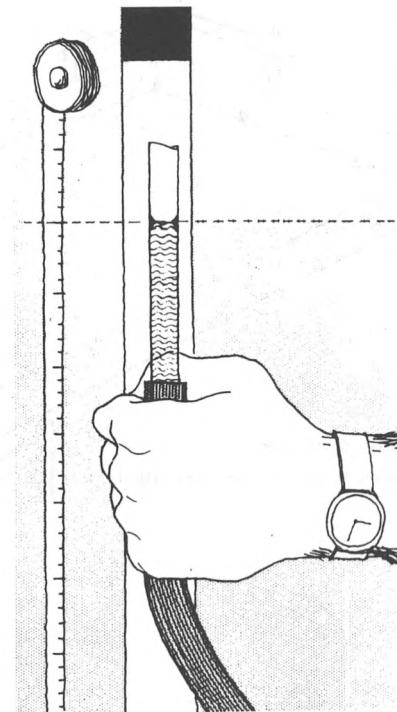
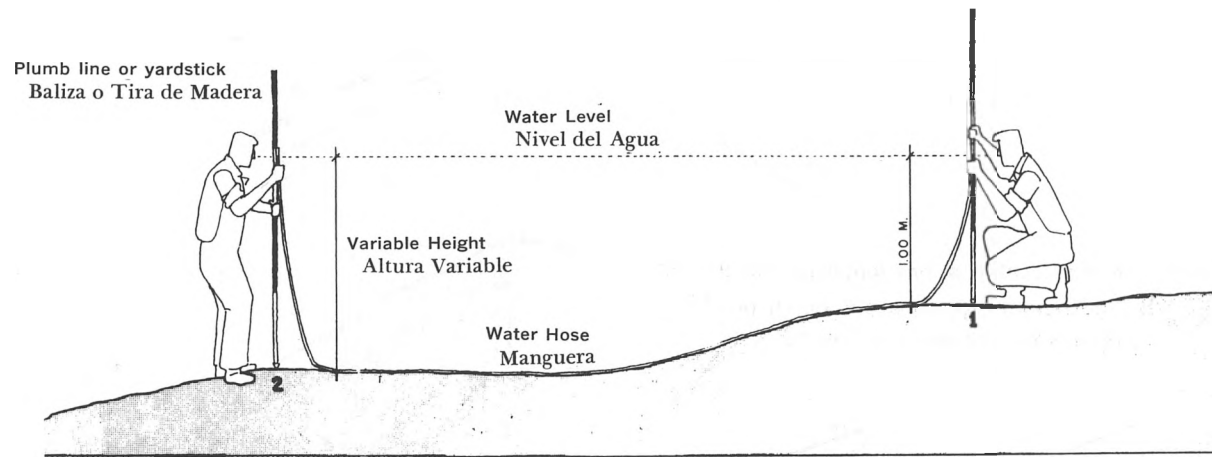

Staking and Laying Out the House  
Apuntando y Localizando la Casa

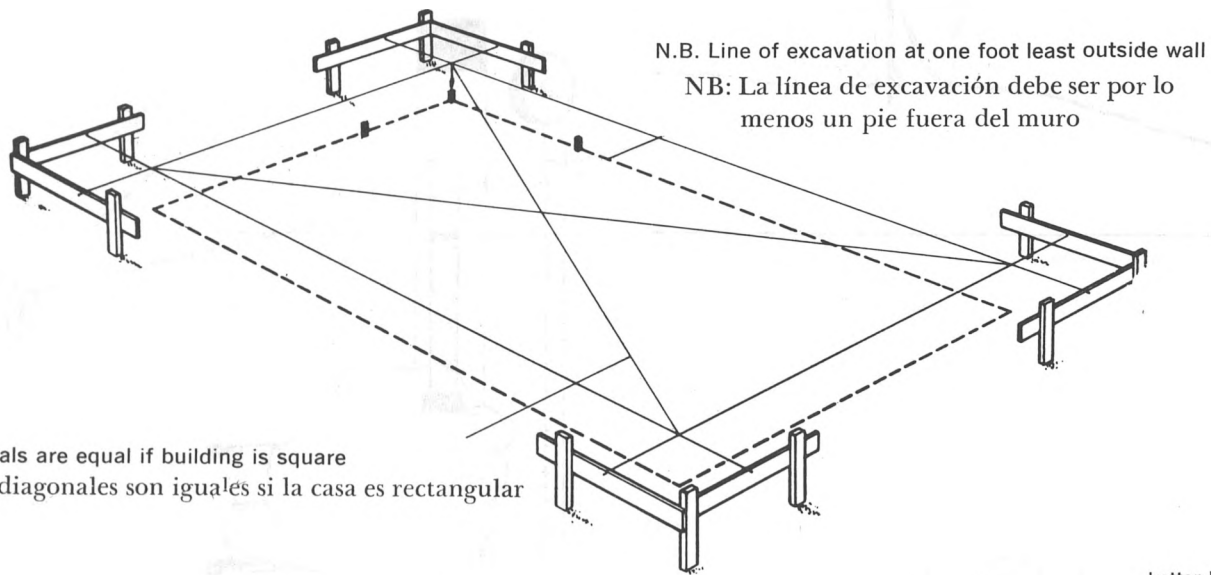

Diagonals are equal if building is square  
Los diagonales son iguales si la casa es rectangular

Outside line of foundation wall  
Línea externa de la fundación

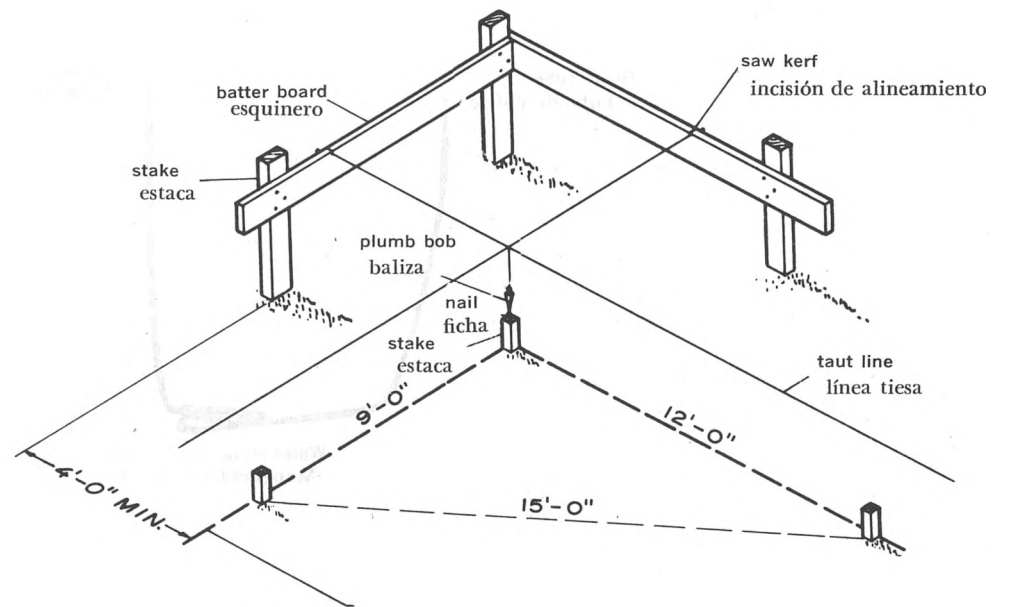

Establishing corners for excavation and footings  
 Estableciendo los rincones para la excavación y las bases

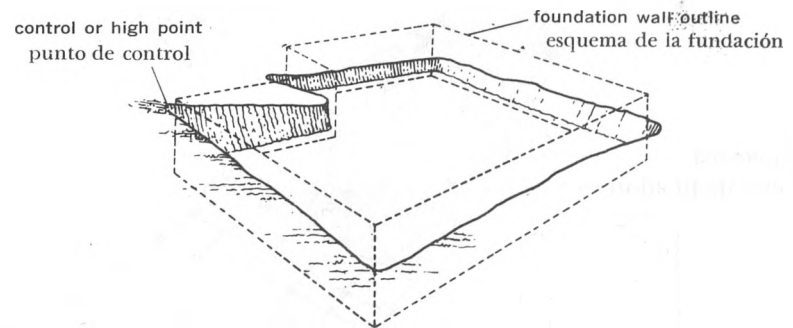
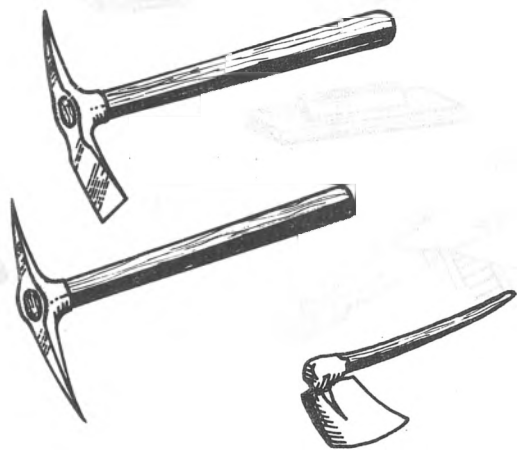
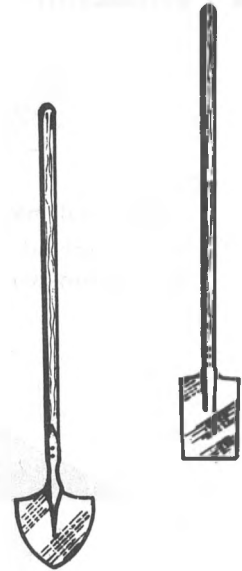
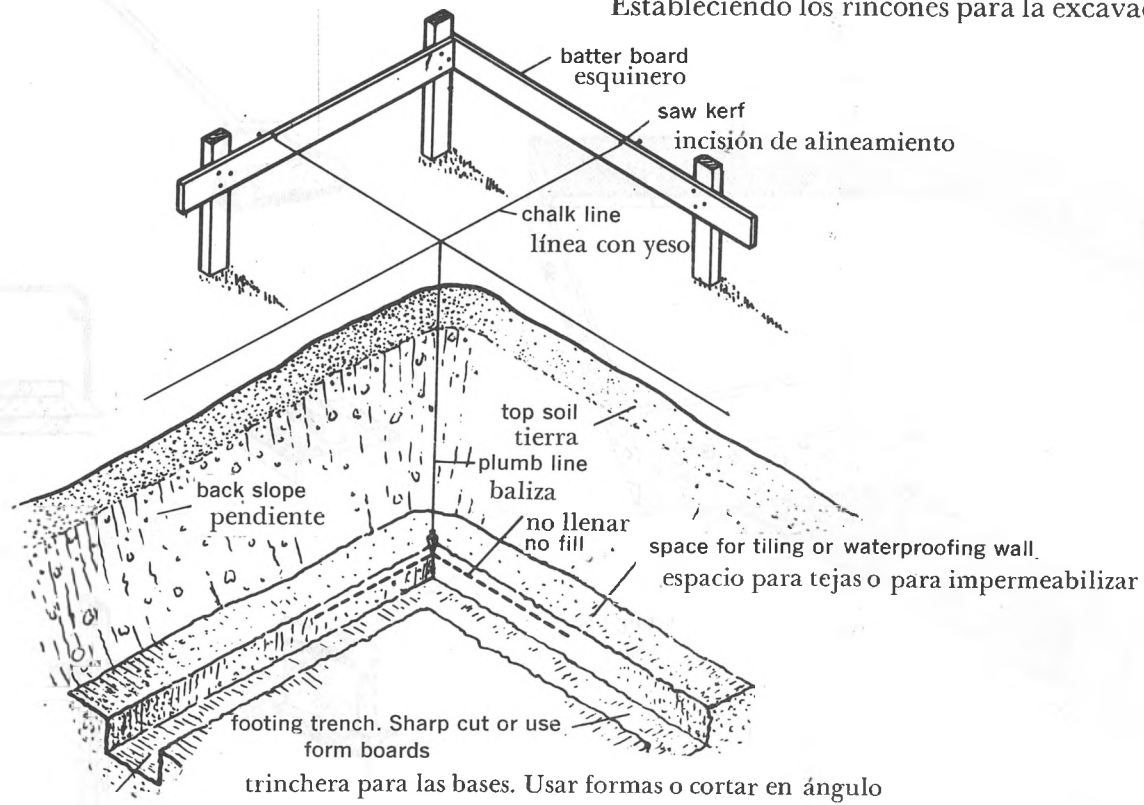

Establishing Depth of Excavation  
 Estableciendo la profundidad de la excavación

# The Foundation

## La Fundacion

foundation wall made up of solid concrete blocks  
 muro contruido de bloques  
 de cimiento 20 cm anchos

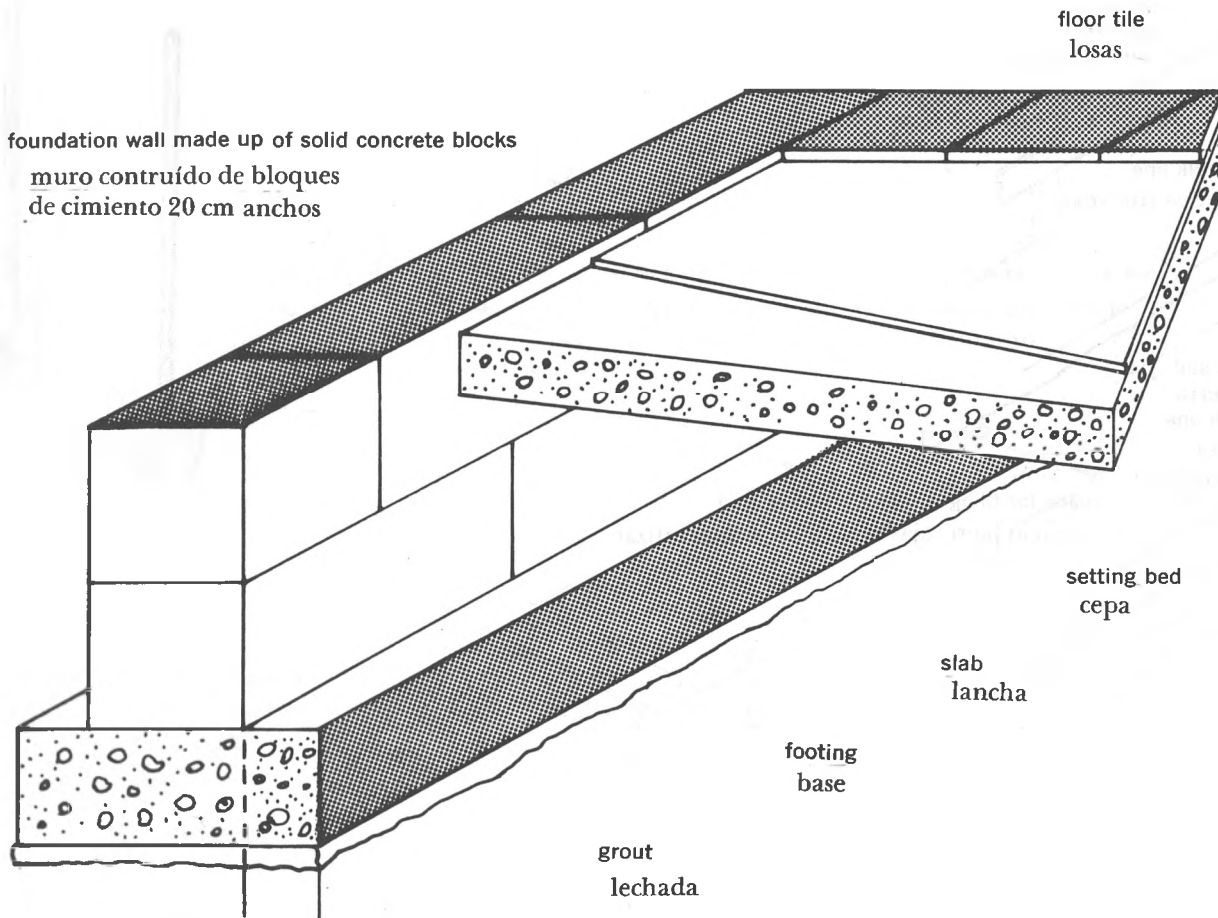

floor tile  
 losas

setting bed  
 cepa

slab  
 lancha

footing  
 base

grout  
 lechada

sloped ground  
 terreno inclinado

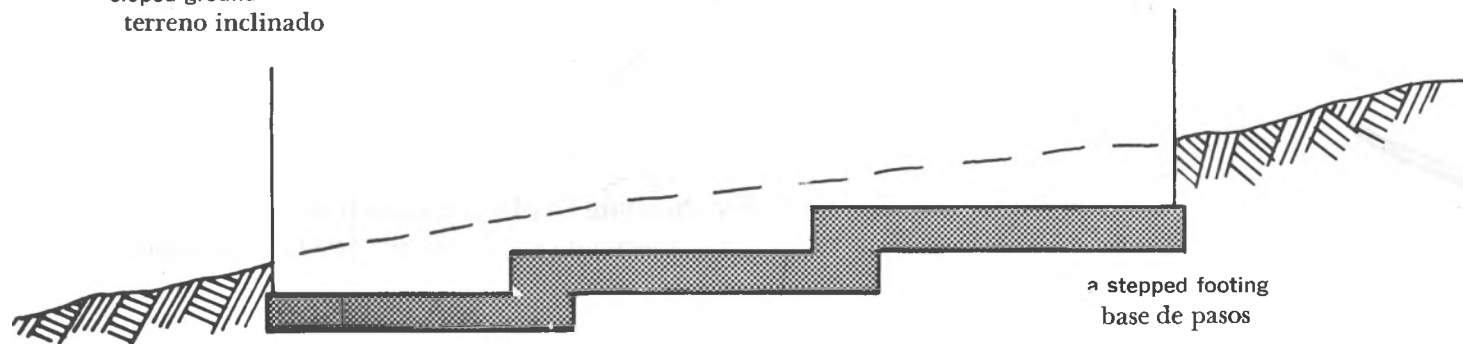

a stepped footing  
 base de pasos

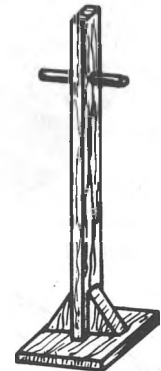
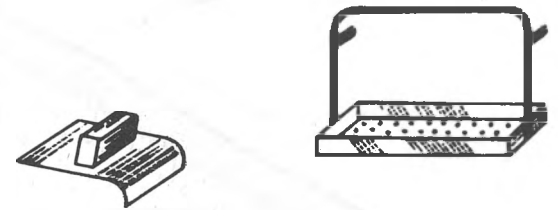

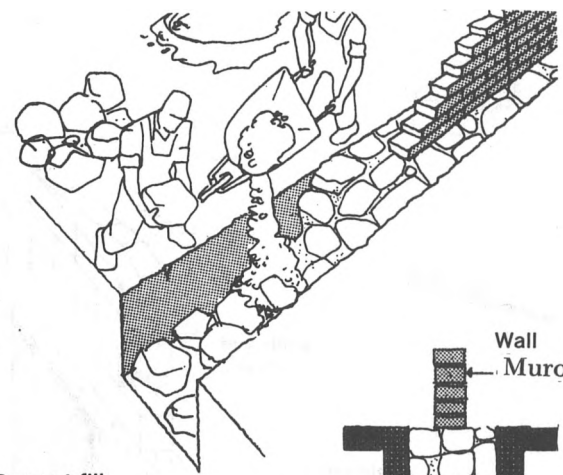
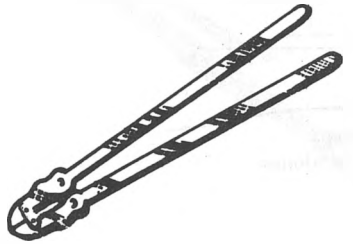

Cement fill  
Cimientos de concreto ciclópeo

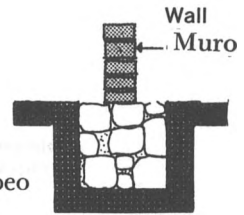

Wall  
Muro  
Cross Section  
Sección

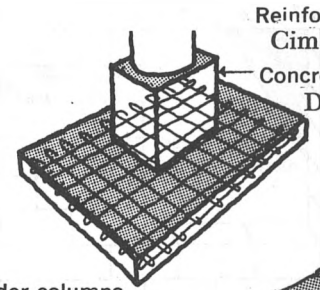

Reinforced Concrete  
Cimientos de Concreto Armado  
Concrete Collar  
Dado de Concreto

Under columns  
Bajo columnas

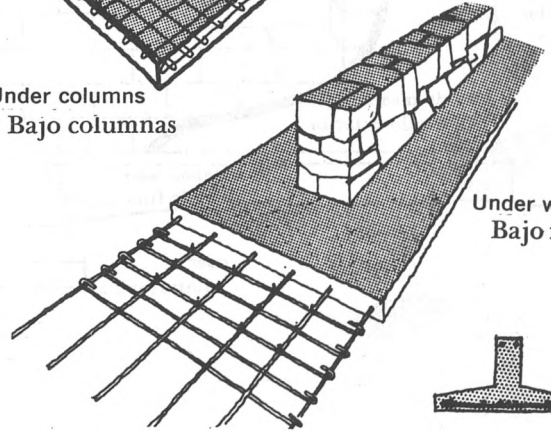

Under walls  
Bajo muros



# The Walls

## Los Muros

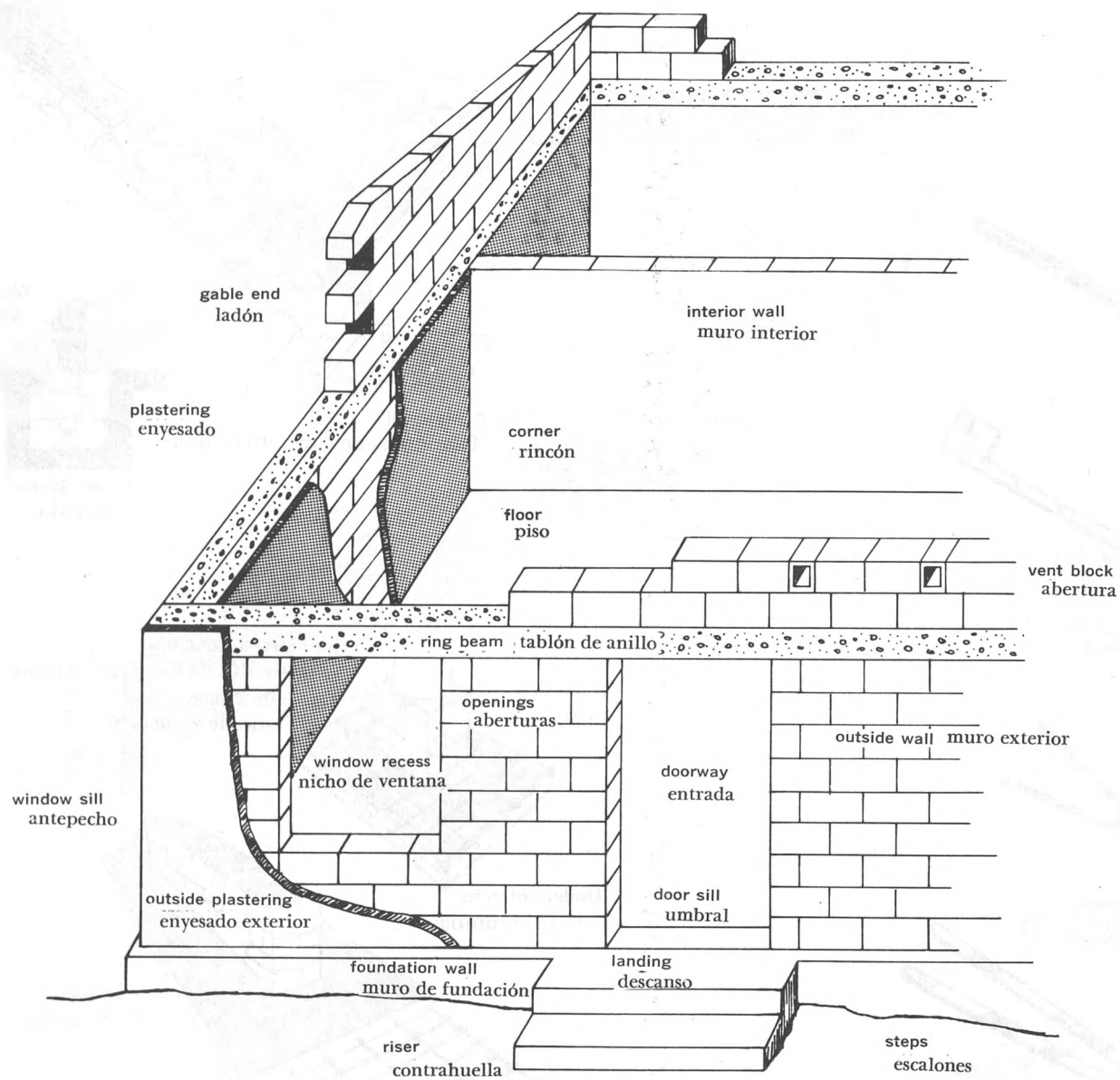

Brick or Cement Block Walls  
Muros de Ladrillo

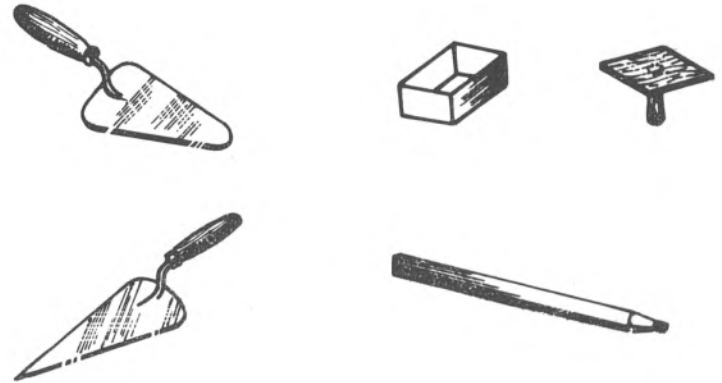
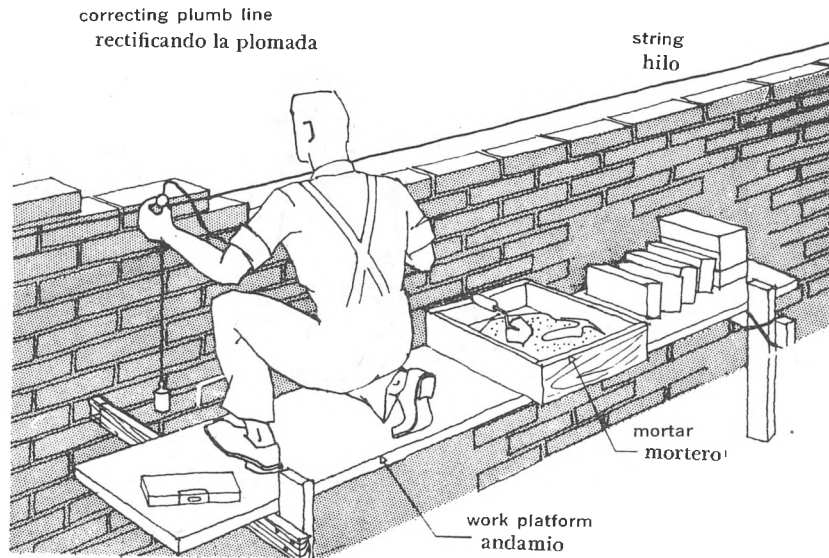

mixer and mortar  
mezclero y mortero

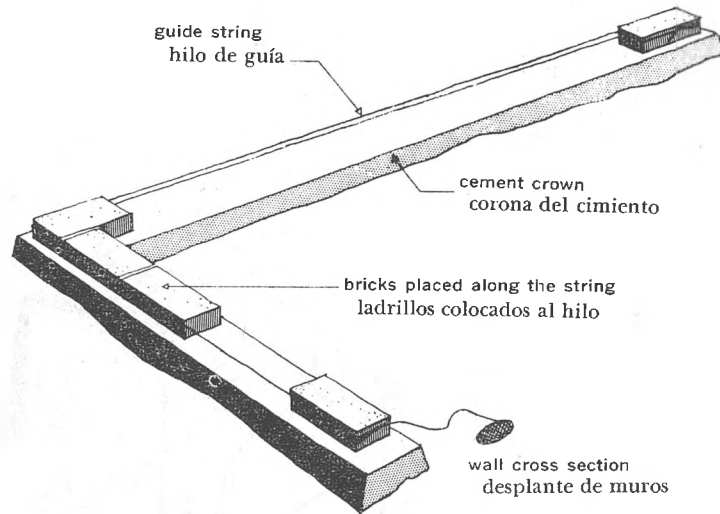
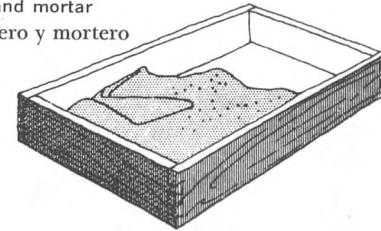

metric tape  
cinta métrica

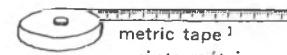

level  
nivel

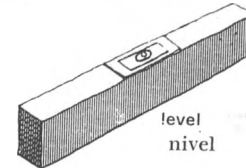

plumb bob  
plomada



string  
hilo



trowel  
cuchara



Village Brick Works  
Para Hacer Ladrillos



Remove large stones from clay or sieve through fine mesh.

Eliminar las piedras grandes del barro, o pasar por cedazo fino.



If not moist, add water. Cover to retard evaporation. To mold, place 4 inches of clay in level, lined pit. Tramp thoroughly, turn and tramp again.



Si el barro es seco, añada agua. Cubrir para atrasar evaporación. Para moldar, pon 4" de barro en hoyo nivelado y forrado con masonería. Mezcle completamente, voltee y mezcle de nuevo.

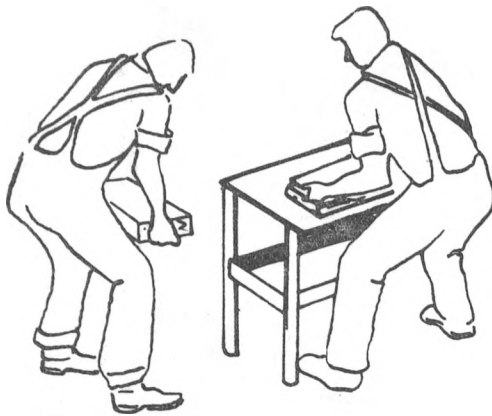

On metal covered table, form bricks in wood mold. Then take off mold and place bricks in drying area. Stack bricks a finger apart on level platform and cover to slow drying. In 3 to 7 days (depending on drying speed), stack to make room for new production. Cover again to complete drying before firing.

Sobre una mesa cubierta de metal, forme ladrillos en un molde de madera. Después saque el molde, y ponga los ladrillos hechos en otra área para secar. Amontone los ladrillos un dedo separado sobre un tablado nivelado y cubra para atrasar el secamiento. Entre 3 a 7 días (dependiendo de la rapidez del secamiento) amontone los ladrillos para dejar espacio para nueva producción. Cubre otra vez para completar el secamiento antes de ponerlos al fuego.

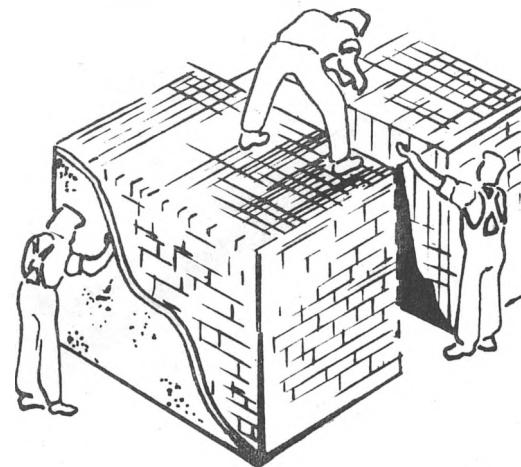
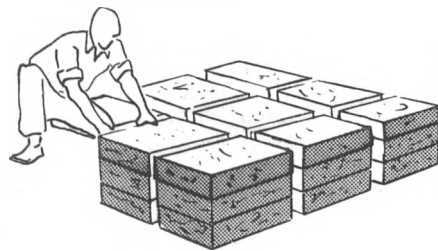
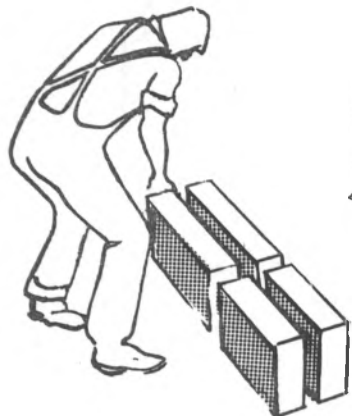

To fire, stack bricks a finger width apart, alternating headers and stretchers, providing minimum touching area and greatest stability. Stack bricks to form rough vaulted tunnels in the kiln. Cover outside of kiln with heavy layers of clay and previously fired bricks (when possible).

Para ponerlos al fuego, amontone los ladrillos un dedo separado, alternando a tizón o al hilo dejando el menos espacio posible entre ellos, y formando rudos arqueados túneles en el horno. Cubre el horno con capas espesas de barro y ladrillos previamente cocinados (cuando posible).

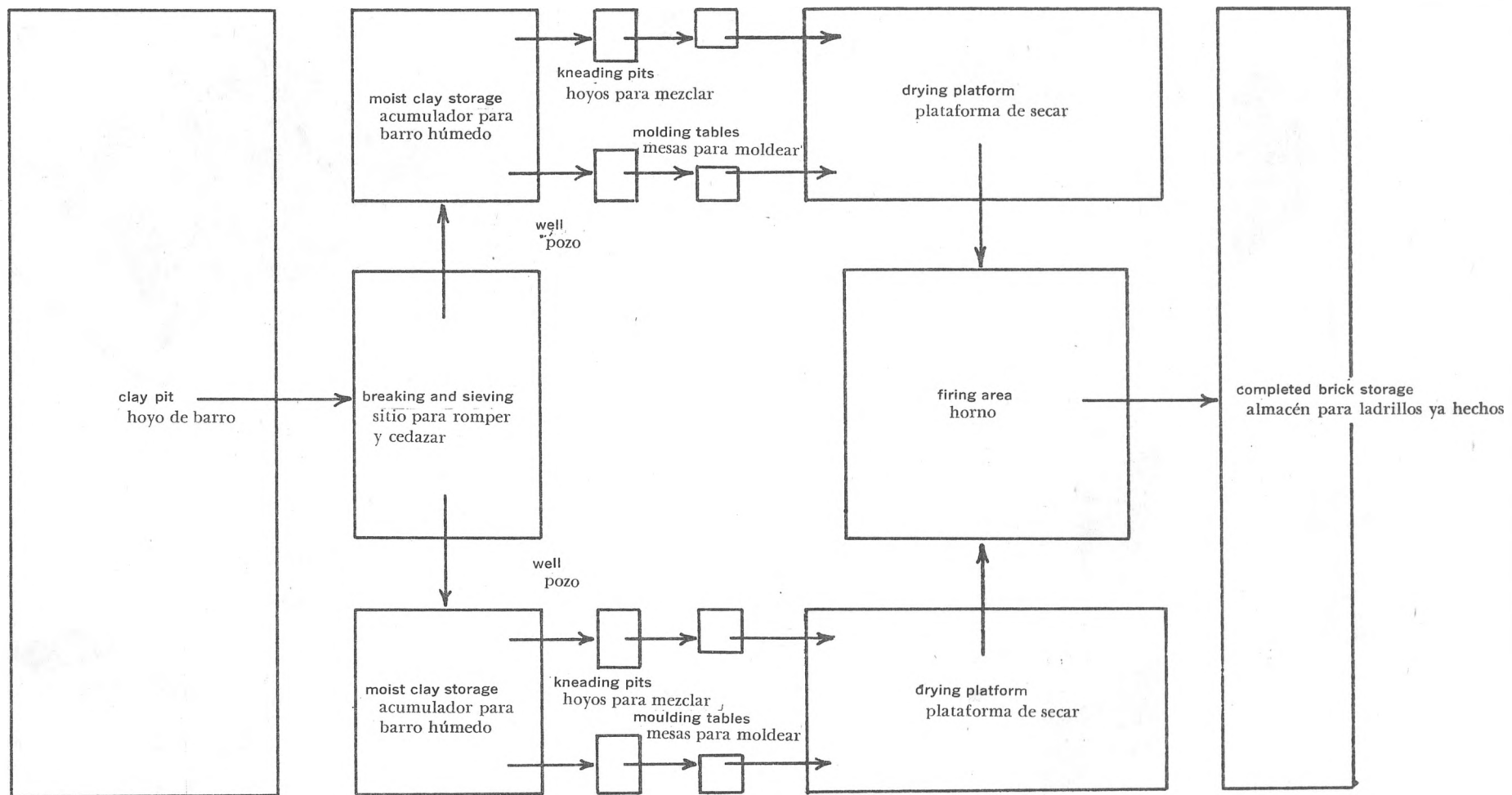

Work Sequence To Make Bricks  
Lugares de Trabajo Para Hacer Ladrillos

# Adobe Walls Muros de Adobe

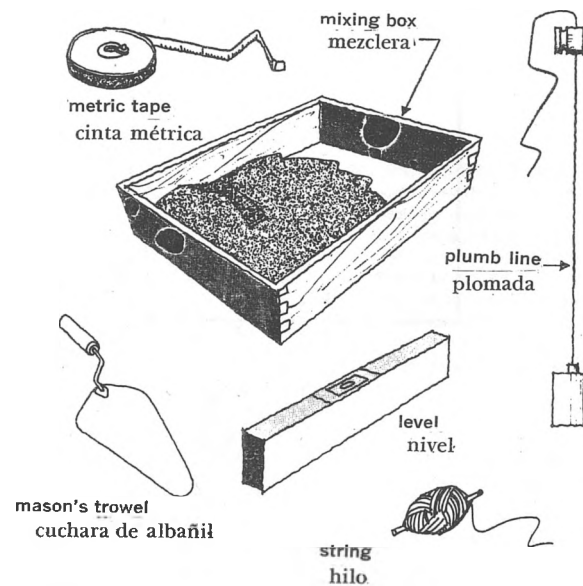
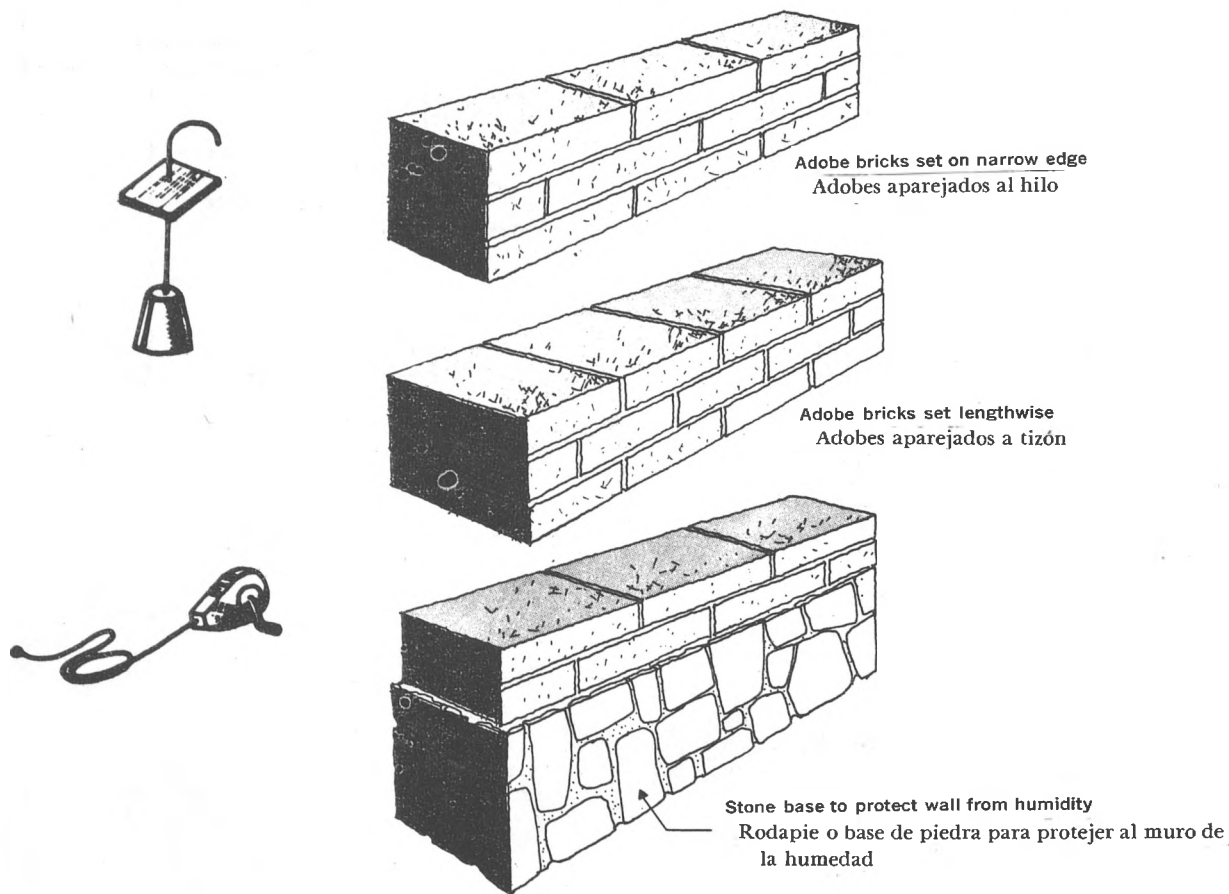
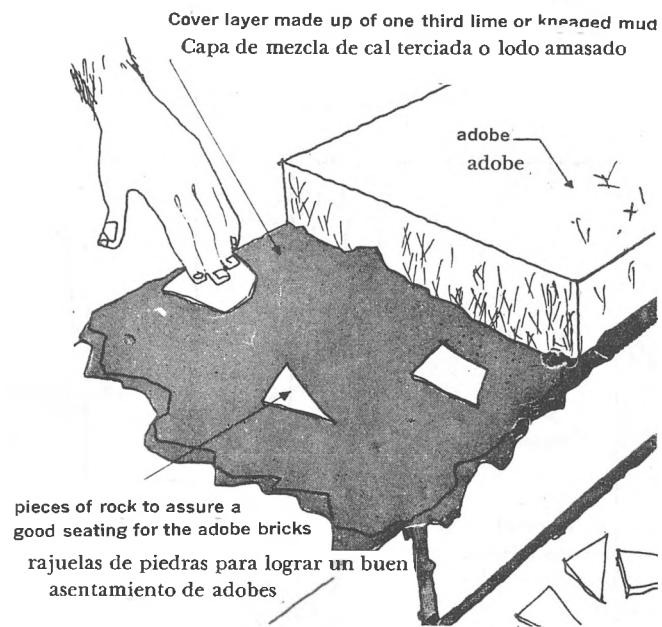
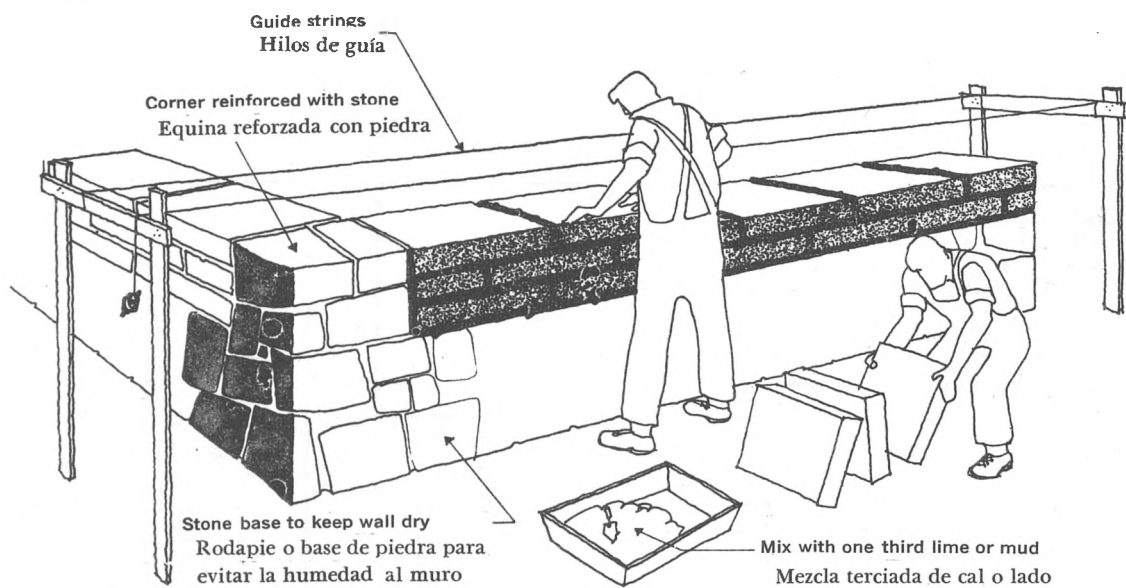

Making Adobe Bricks  
Ladrillos de Adobe

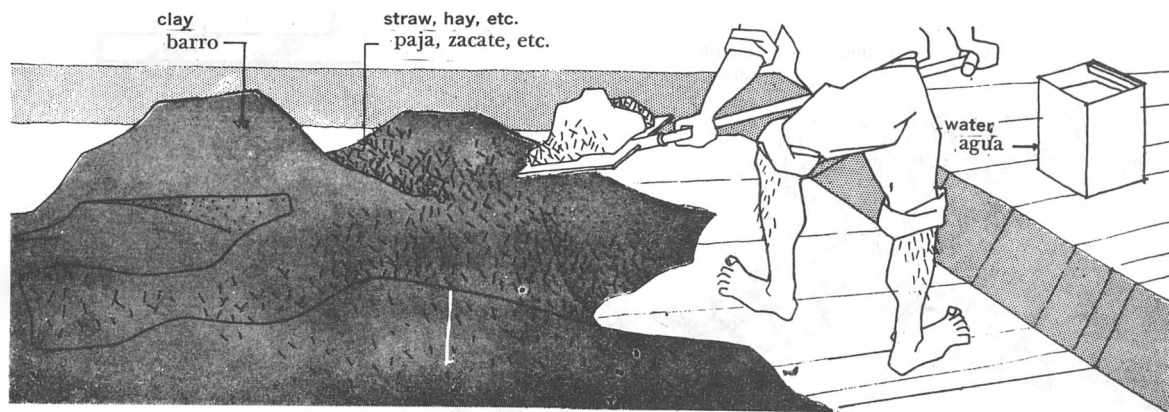

wood mold  
molde de madera o "garrilla"

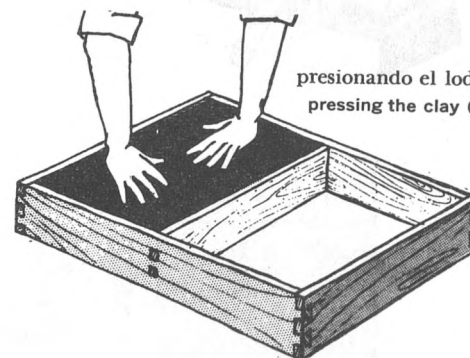
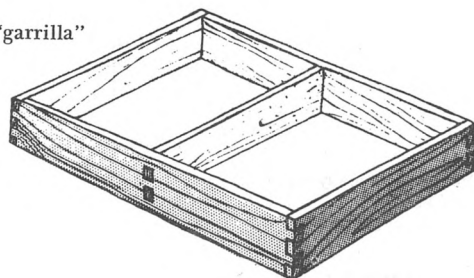

presionando el lodo  
pressing the clay (mud) into the form

molding adobe bricks is done with wood forms, as shown, having the following dimensions: 40 cms long; 30 cms wide; 8 cms deep. Another good size is: 40 cms long; 20 cms wide; 8 cms deep.

el moldeo de los adobes se hace en formas de madera, como el de la figura, con las siguientes dimensiones: 40 cms largo; 30 cms ancho; 8 cms alto. Otro tamaño muy conveniente es: 40 cms largo; 20 cms ancho; 8 cms alto.

supply of recently made adobe bricks  
reposito de adobes recién hechos

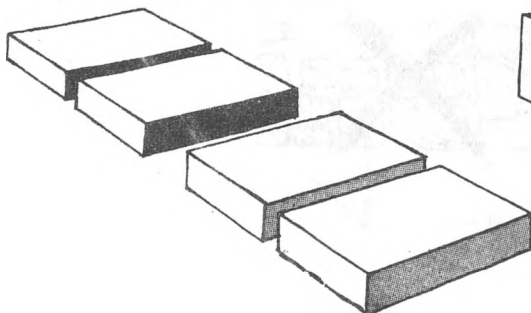

pieces in drying position  
colocación de las piezas para secar

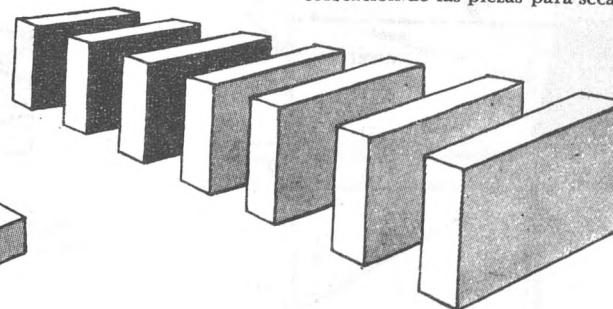

Stone Walls  
Muros de Madera

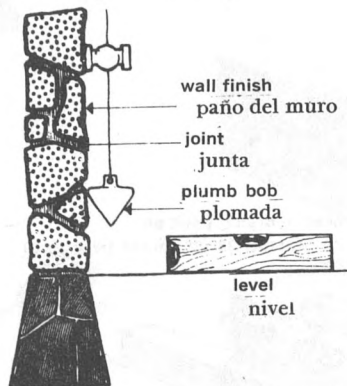
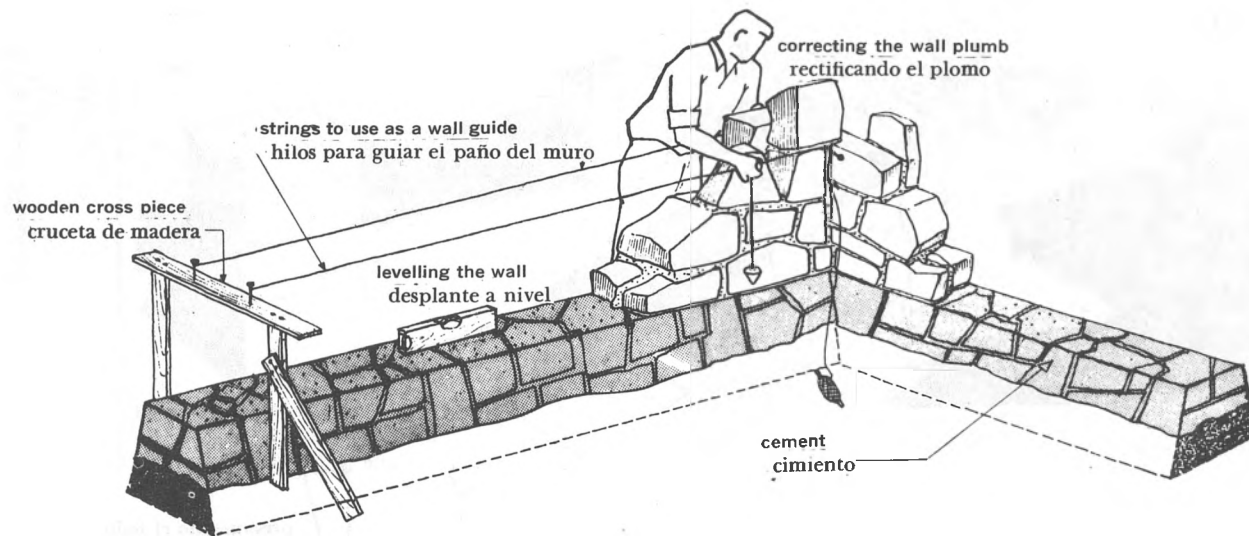

joints should alternate vertically and horizontally: correct  
juntas cuatrapeadas: correcto

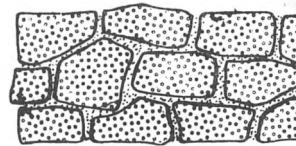

joints incorrectly laid  
juntas no cuatrapeadas: incorrecto

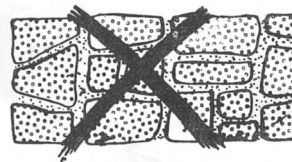

Using Plaster to Finish the Walls  
Aplanado de Yeso

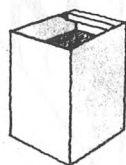
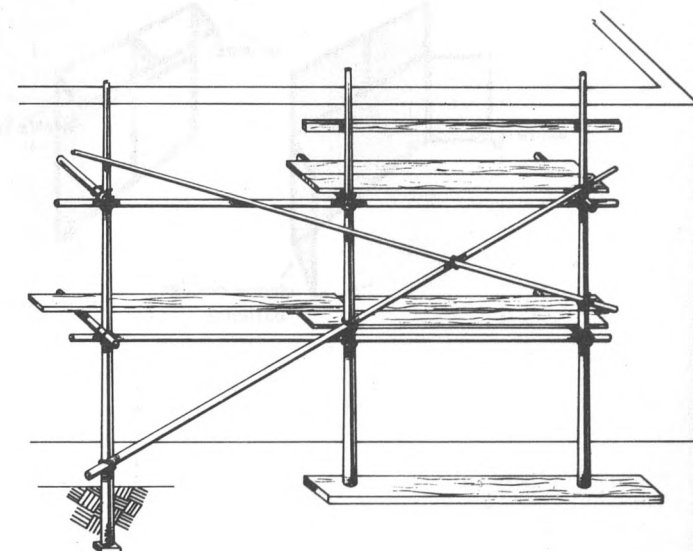
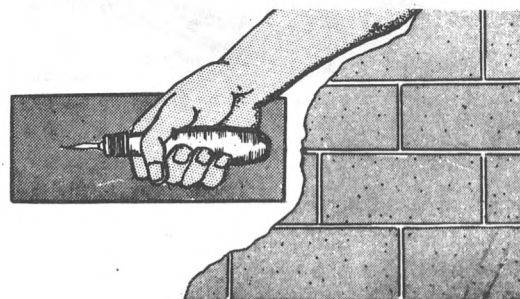
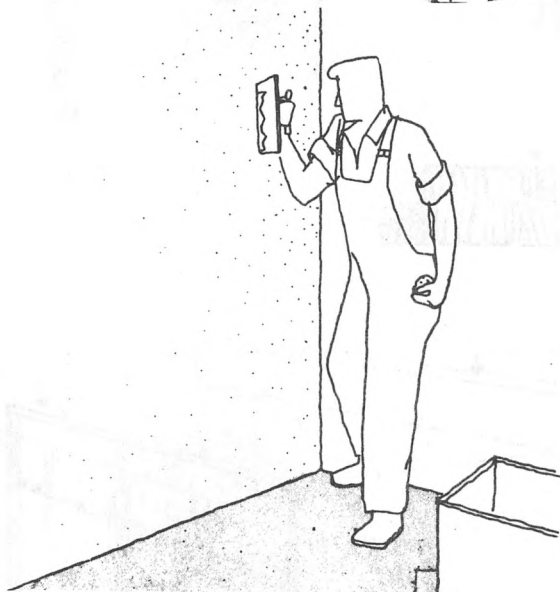
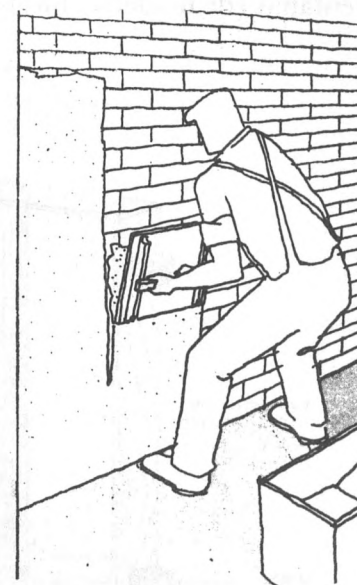
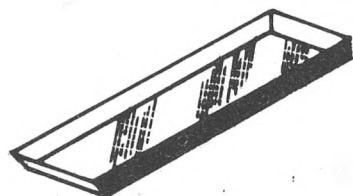

30 liters water  
30 lts. agua

Proportions:  
Proporción:



40 kgs. plaster  
40 kgs. yeso



2 kgs. cement  
2 kgs. cemento

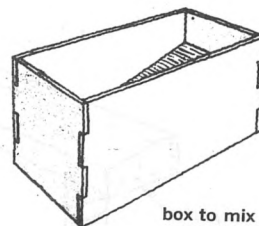

box to mix plaster  
yesera o artesa



Doors  
Puertas

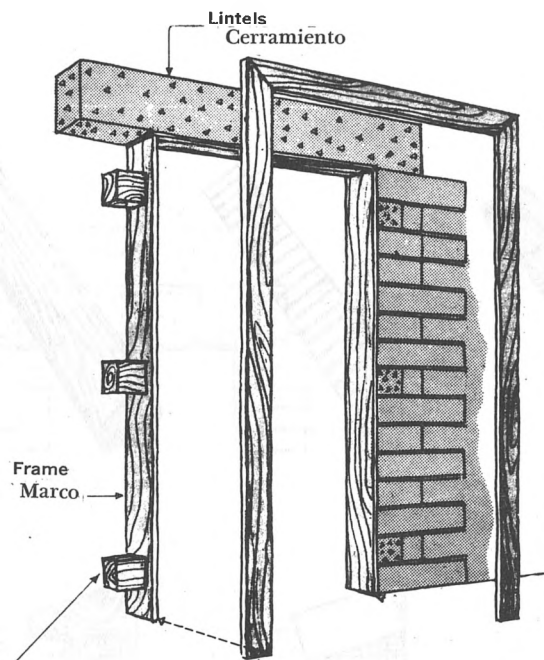

Pegs to attach door to wall  
Canes que se empotran para fijar al muro

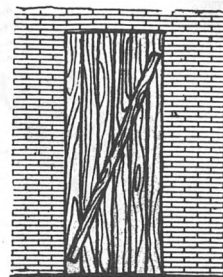
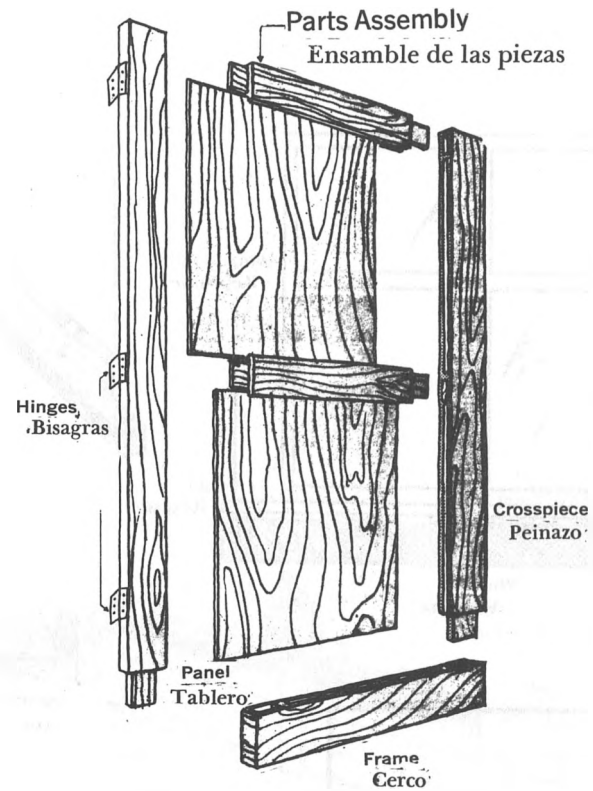

Plank Door  
Puerta de Tablones

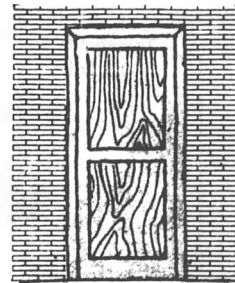

Panel door  
Puerta entablada

Thresholds and Window Sills  
Sardineles y Repisones

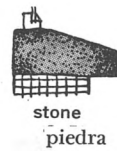
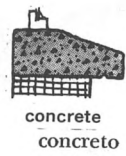
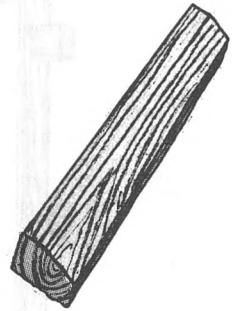
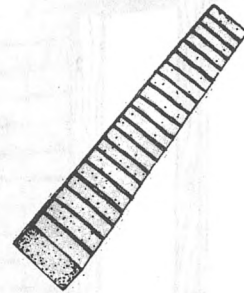
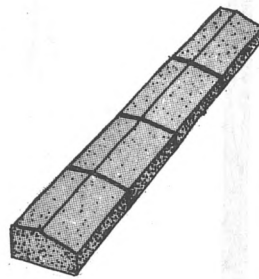
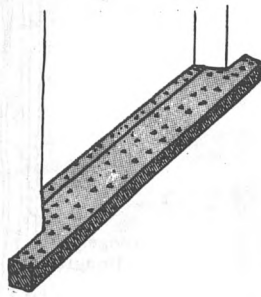
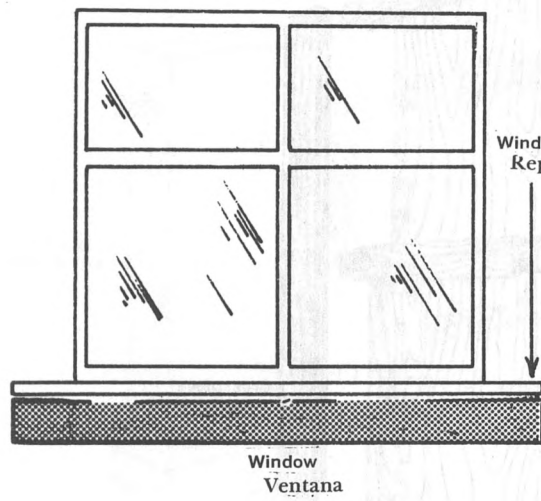

concrete  
concreto

stone  
piedra

brick  
ladrillo

wood  
madera

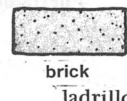
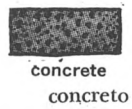
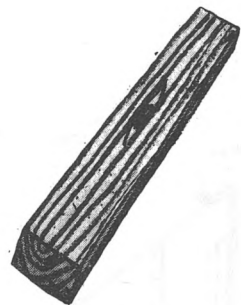
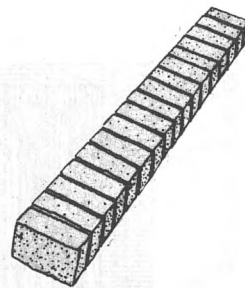
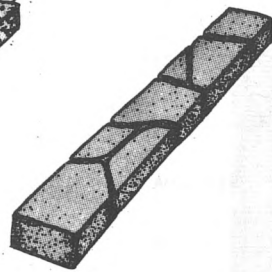
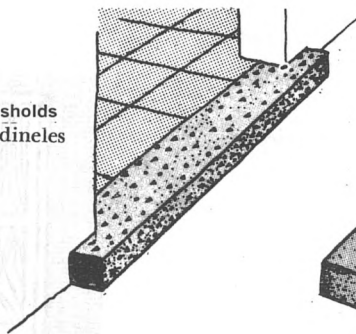
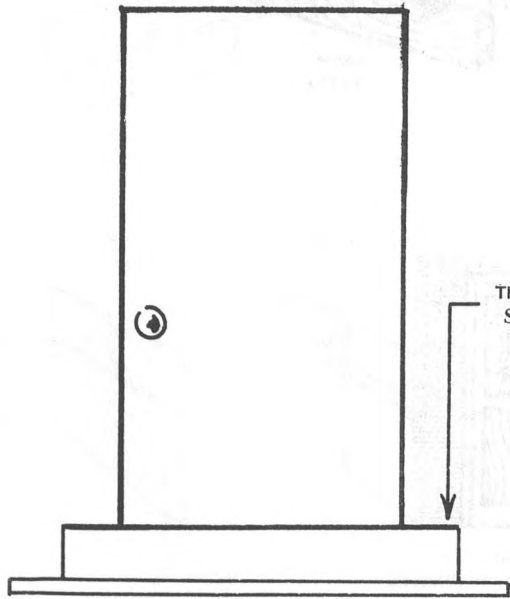

concrete  
concreto

stone  
piedra

brick  
ladrillo

wood  
madera

Windows and Doors  
Ventanas y Puertas

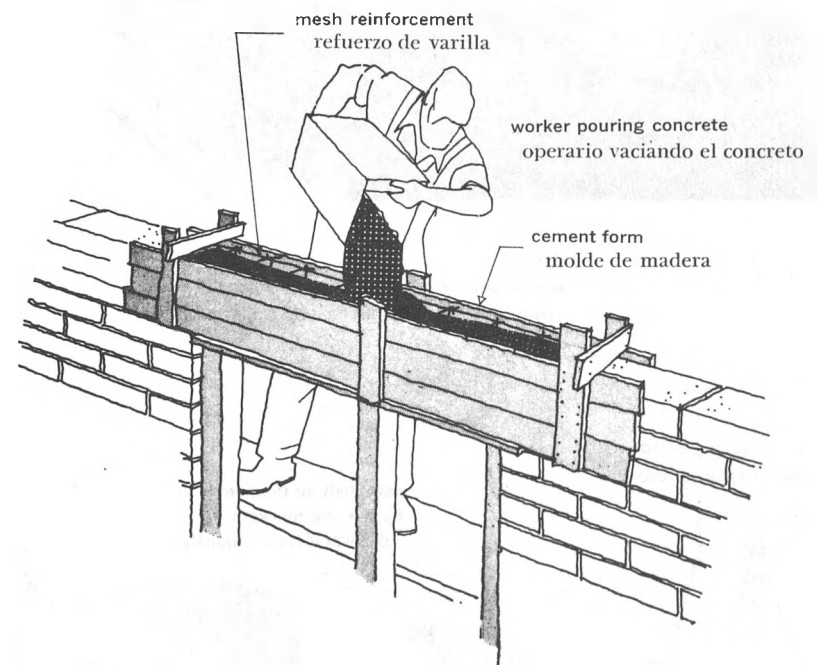
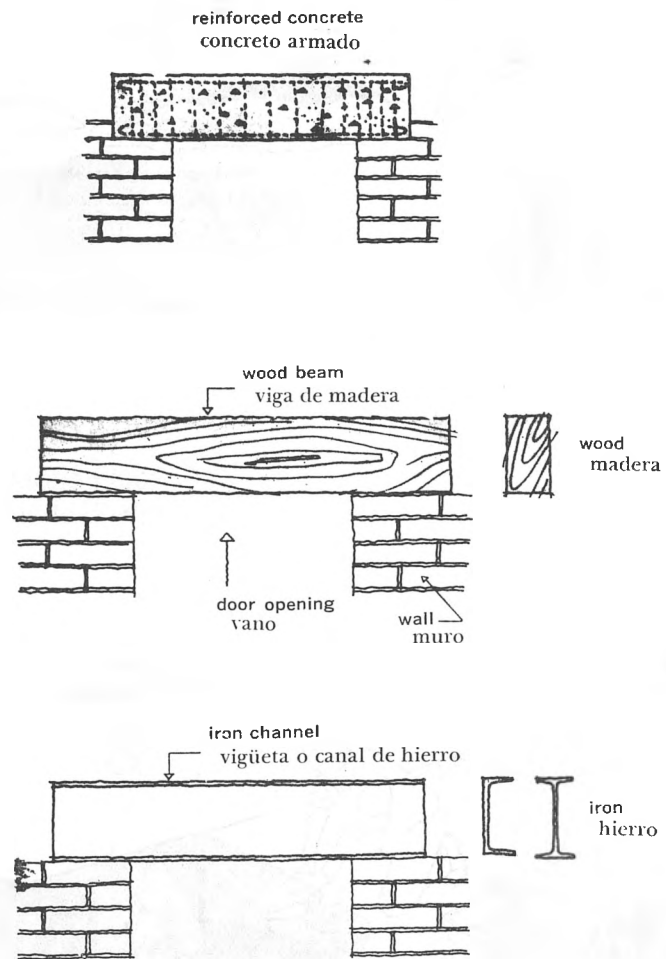

# The Floors Los Pisos

## Concrete Cimiento

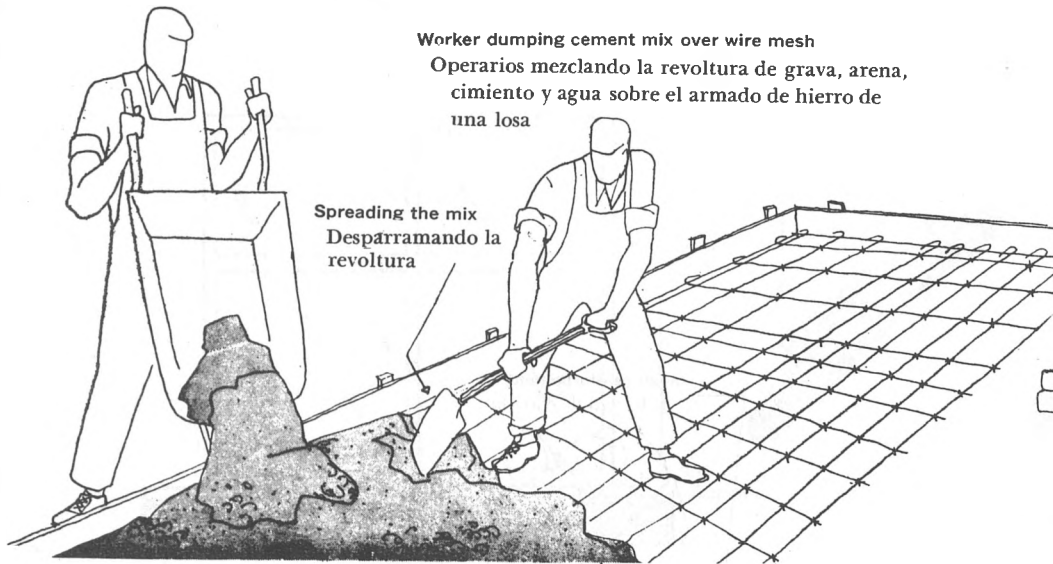

## Mixing Concrete Mezclando el cimiento



simple concrete floor over tamped earth  
piso de cimiento sobre suelo apisonado

worker tamping ground  
operario apisonando



establishing floor level  
by placing markers  
colocación de "maestras"

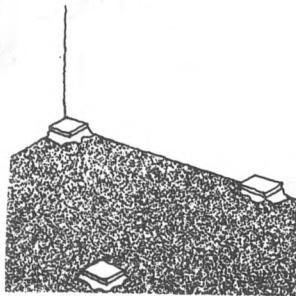

putting on coating  
vaciando el firme



smoothing off floor  
puliendo el acabado



## Stone Floors

### Pisos de Piedra Laja

Worker tamping ground for cement layer  
Operario apisonando el suelo para tender el firme de cemento



Worker placing markers  
Operario colocando las muestras que servirán de guía para colocar las piezas del piso terminado

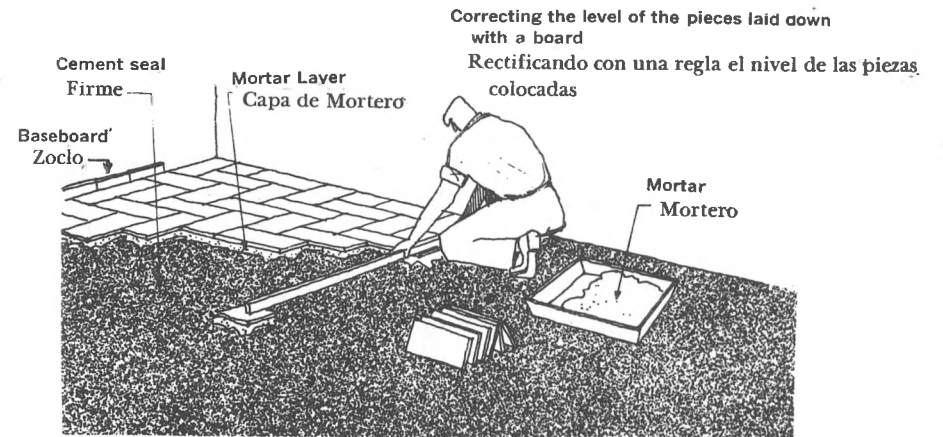

## Flagstone Floor Pisos de Piedra

Tamping  
Apisonando

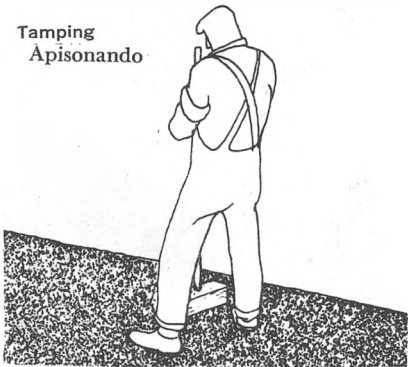

Correcting the level of the finished floor  
Rectificando el nivel de piso acabado



Wood Floor  
Pisos de Madera

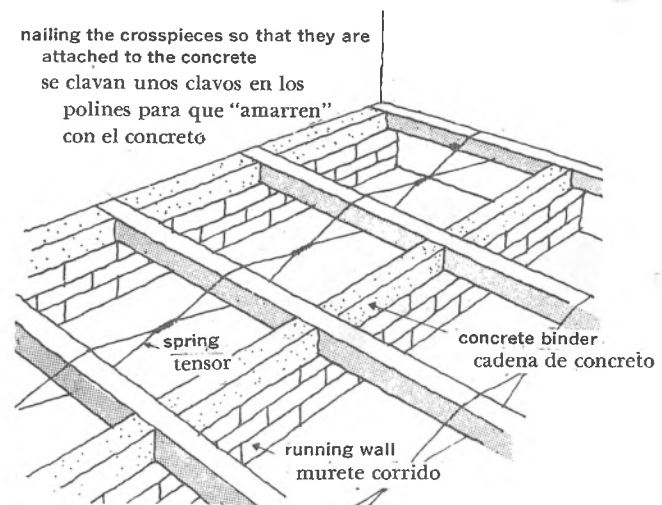
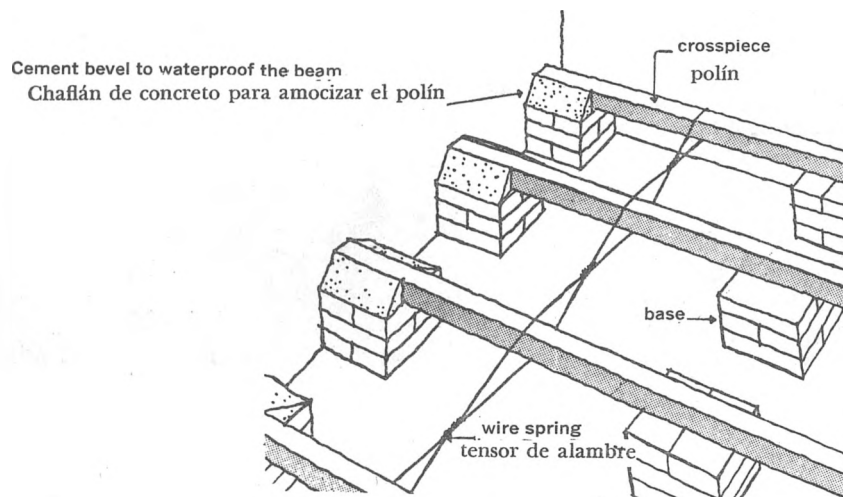

worker nailing the floorboards to the crosspieces  
operario clavando las duelas a los polines

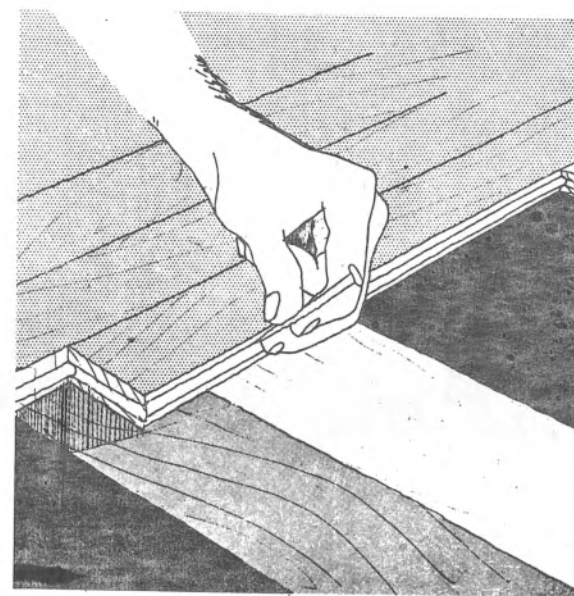
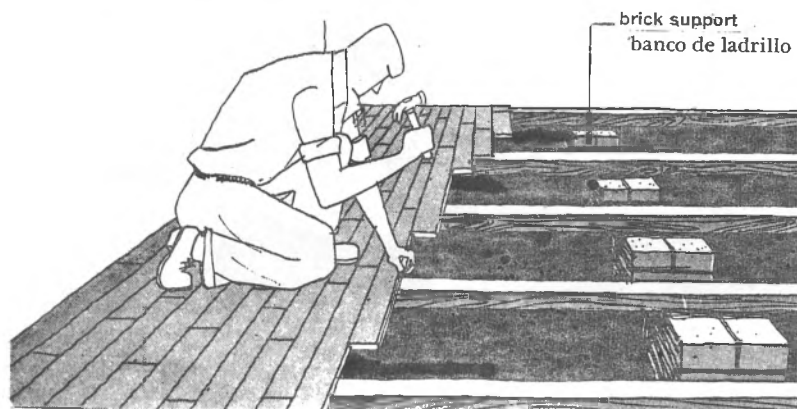

The Roof  
El Techo

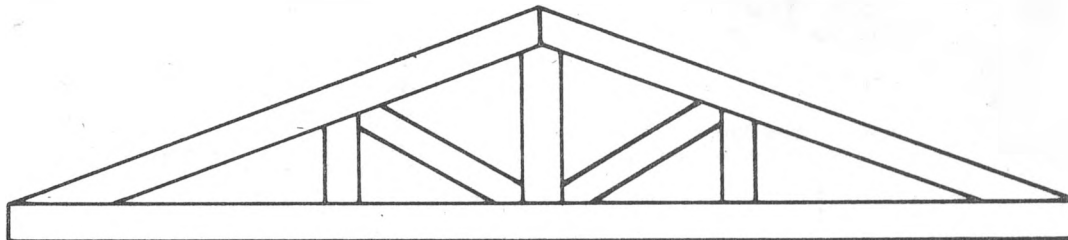
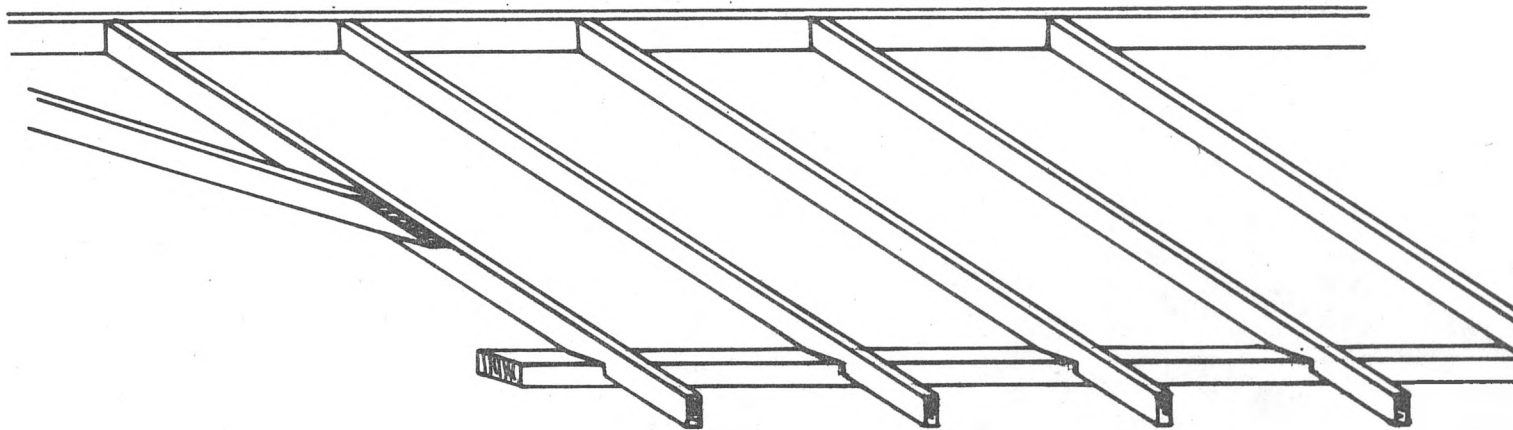
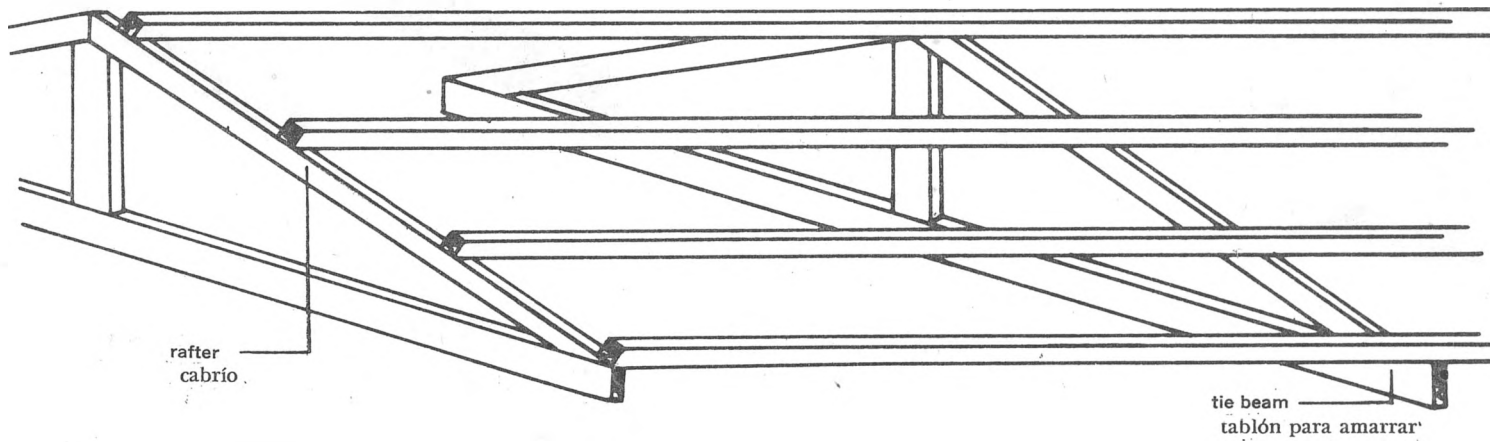

Clay Tile Roof  
Techo con Tejas de Barro

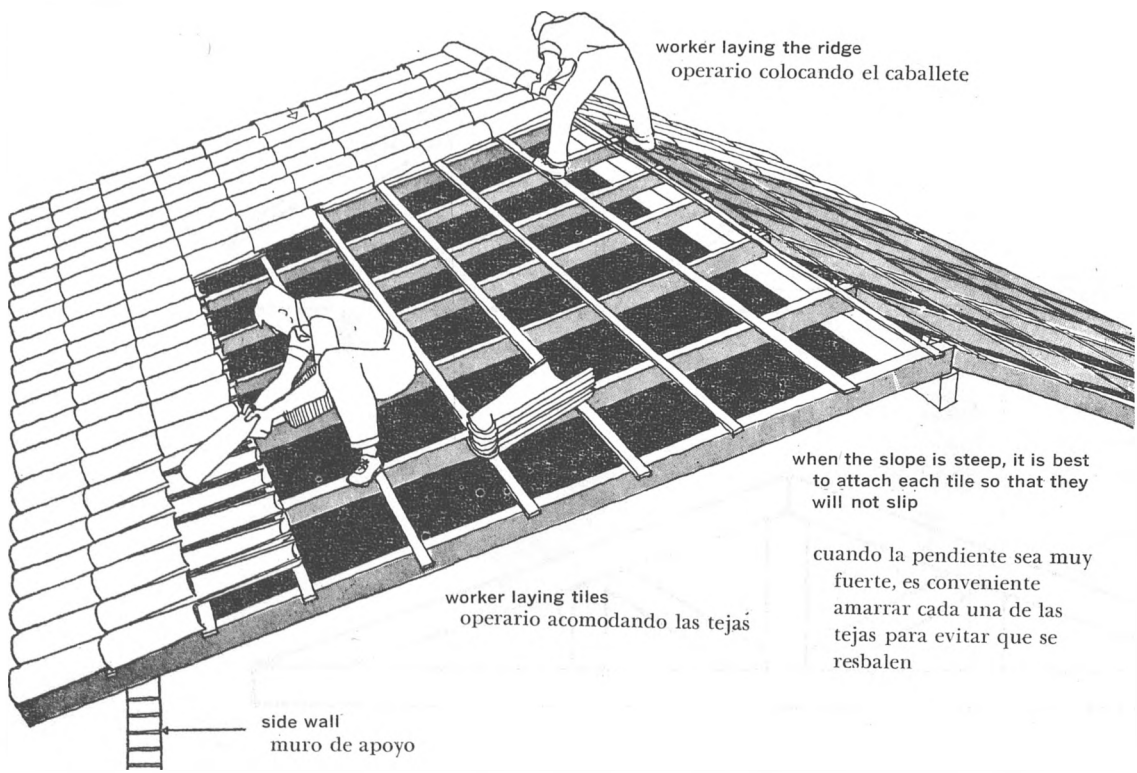
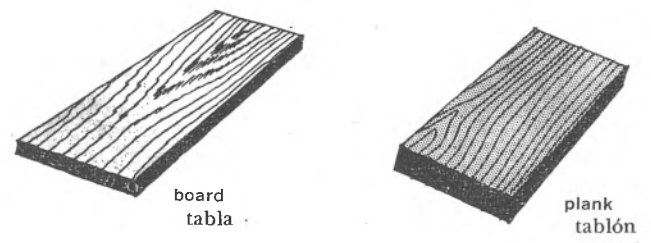
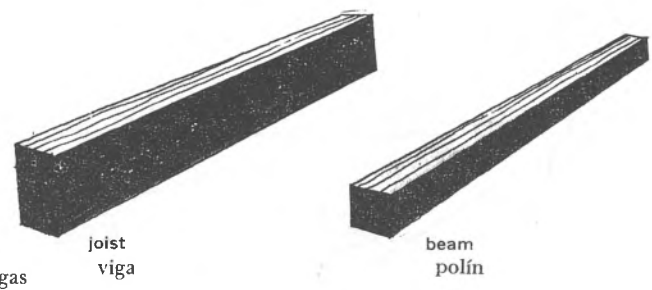
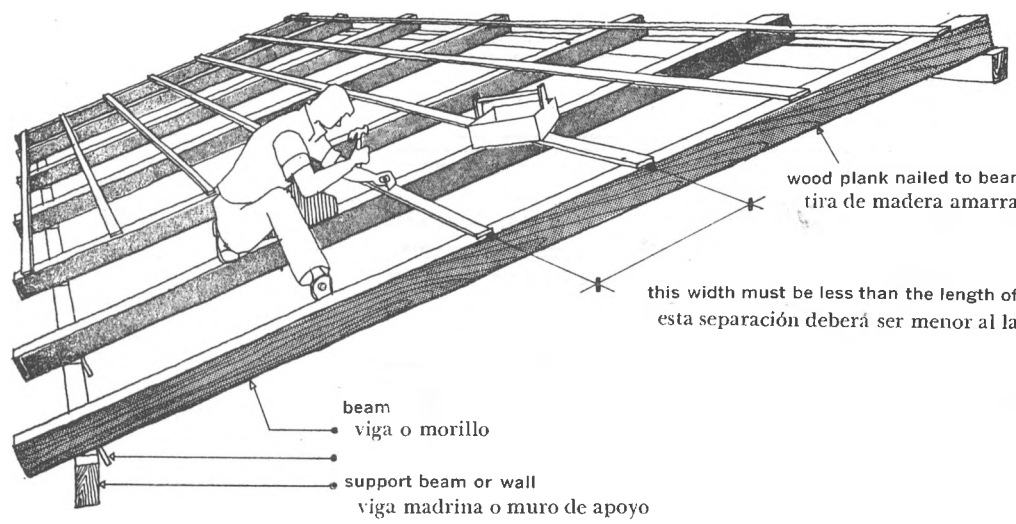

worker laying the ridge  
operario colocando el caballete

worker laying tiles  
operario acomodando las tejas

side wall  
muro de apoyo

when the slope is steep, it is best  
to attach each tile so that they  
will not slip

cuando la pendiente sea muy  
fuerte, es conveniente  
amarrar cada una de las  
tejas para evitar que se  
resbalen

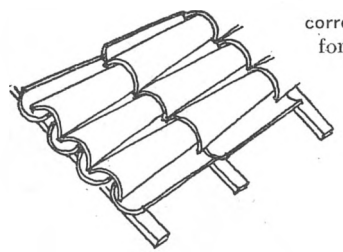

correct method of laying tiles  
forma correcta de colocar las tejas



gutter tile  
canal

Aluminum Roof  
Techo de Aluminio

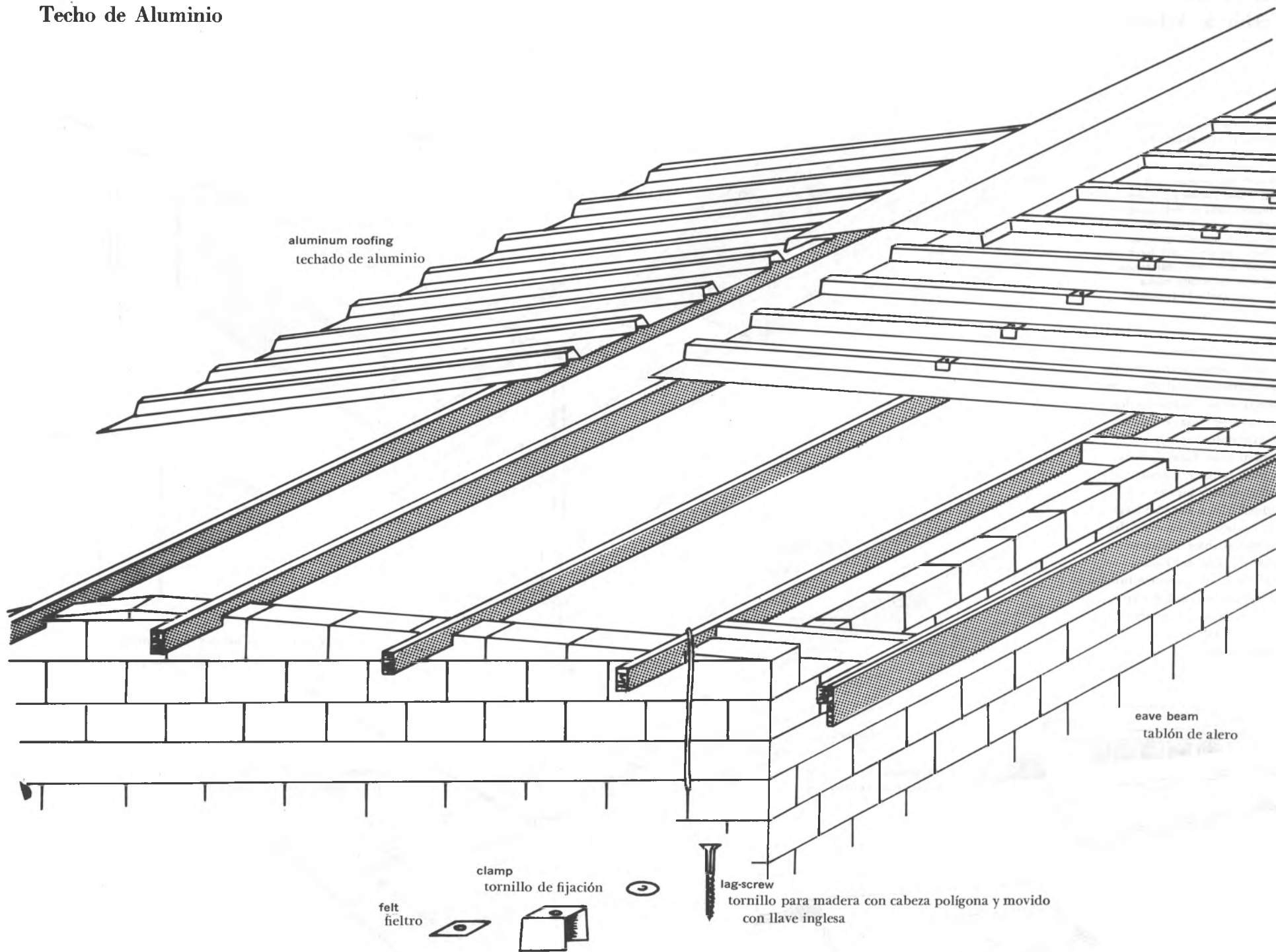

## Asbestos Roof Techo de Asbestos

Asbestos-cement sheets are made industrially by a method which mixes these two materials, and produces sheets of different thicknesses and sizes. These sheets are used for house roofs or industrial and store roofs. They are water and fireproof, good as insulation against both heat and cold, and their resistance to rot and deformity make them very useful in building.

Las láminas de asbestos-cemento están hechas por un procedimiento industrial que mezcla estos dos materiales produciendo placas duras de diferentes espesores y dimensiones. Estas láminas se usan indistintamente para techar casas y locales industriales o para bodegas. Sus cualidades impermeables, incombustibles, aislantes de calor y el frío del medio ambiente, su indeformibilidad, su imputrescibilidad y su resistencia las hacen ser de gran utilidad para la construcción.

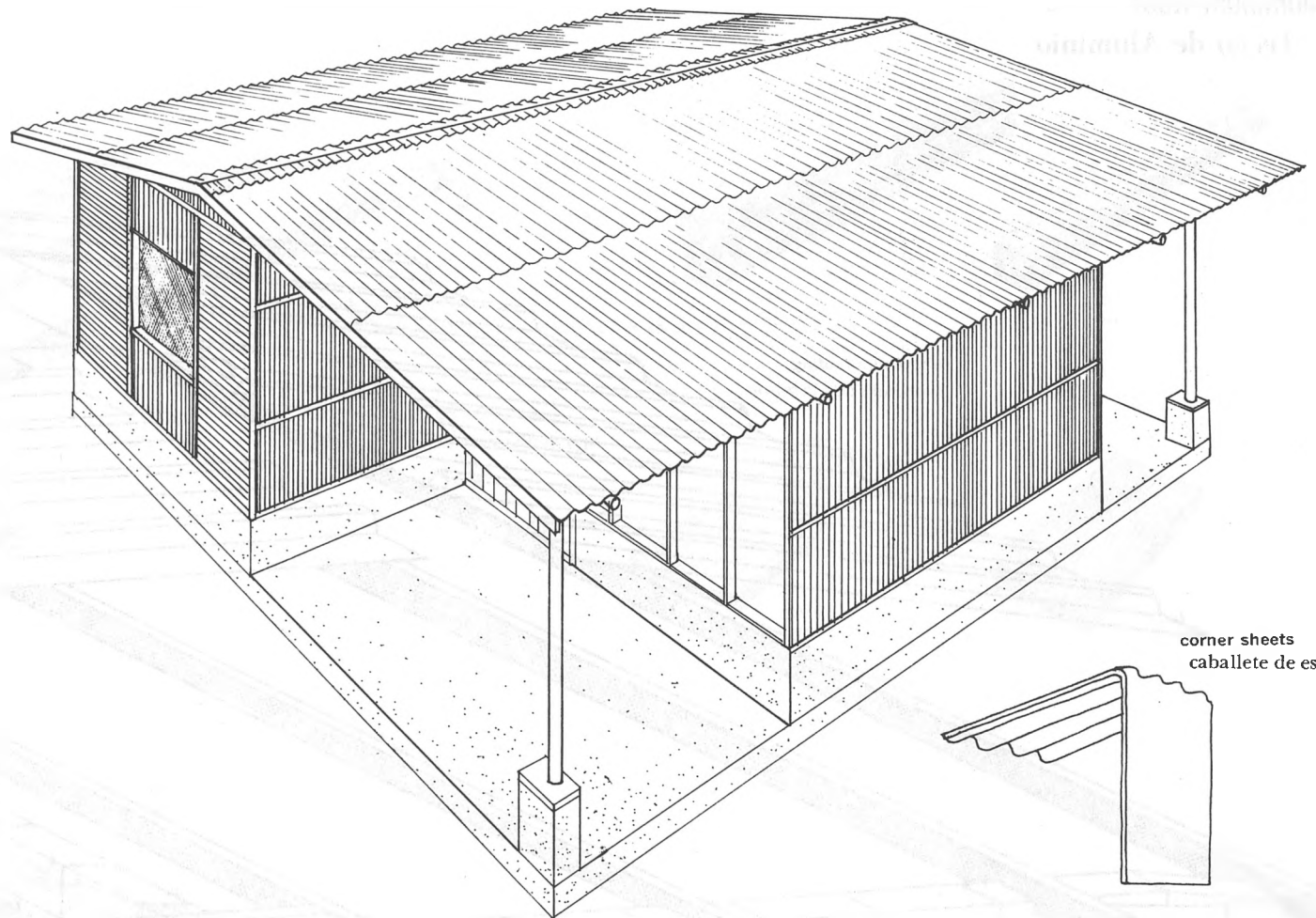

corner sheets  
caballete de esquina

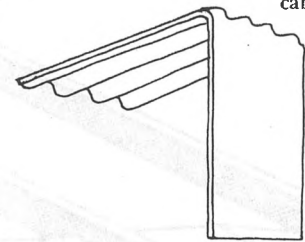

shapes and sizes needed for assembly  
formas y tamaños necesitados para construir

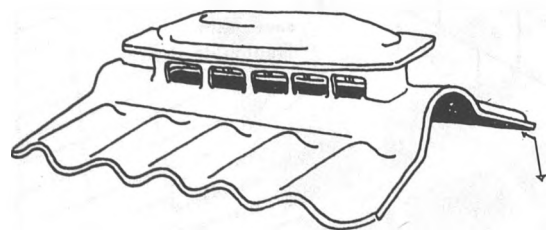

ridge sheets  
caballete de centro

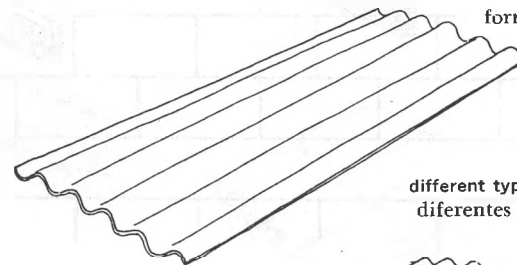
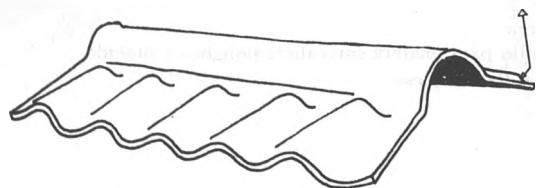

different types of sheets  
diferentes clases de láminas

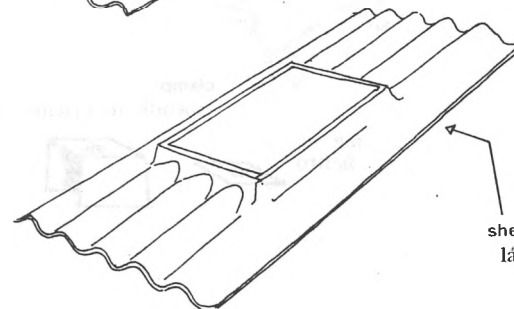

sheet with skylight  
lámina con tragaluz

thatching board 12" x 16" drilled with 1/4" holes  
completed section

tabla para empajar (12"x16")  
perforada con hoyos de 1/4"  
de diámetro

loose bundle of thatch grass  
bulto de zacate

rafter  
viga

starting from the top of bundle,  
push thatching board against  
grass ends repeatedly until  
surface is even and level.

comenzando a la cima del  
bulto, empujan la tabla para  
empajar contra las puntas  
de la paja repetidamente  
hasta que la superficie esté  
uniforme y nivelada

completed section  
sección acabada

with treated twine and wooden needle, bind each  
layer to stakes

con tramilla y aguja de  
madera, se debe atar cada  
capa a las estacas

Thatched Roof  
Techo de Zacate

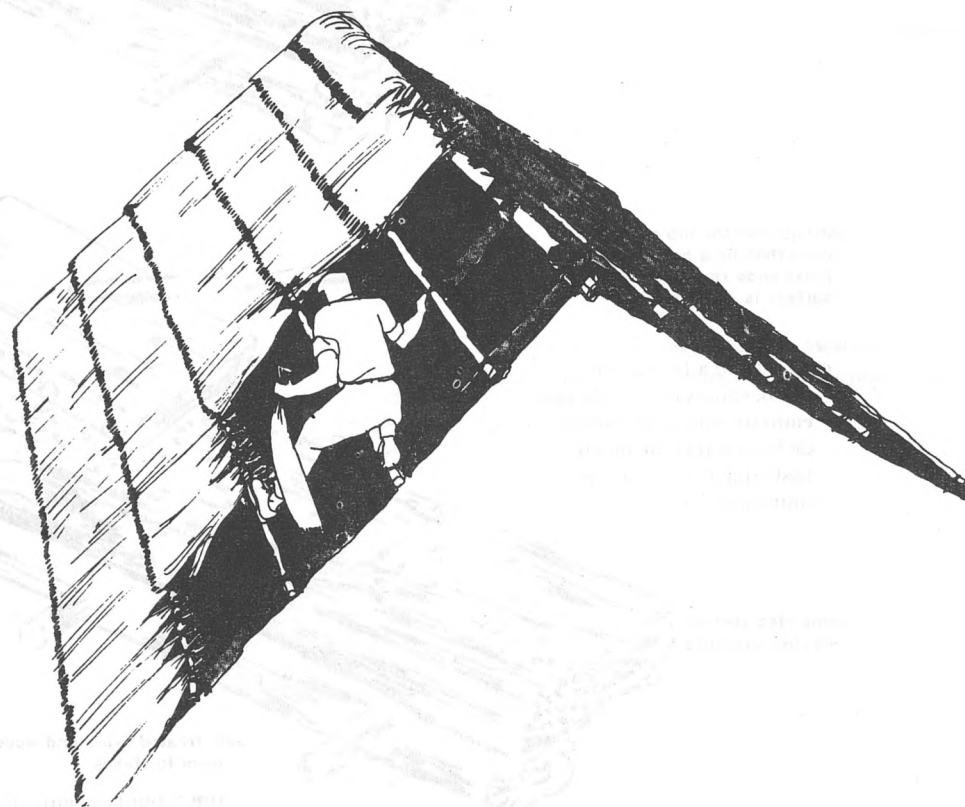
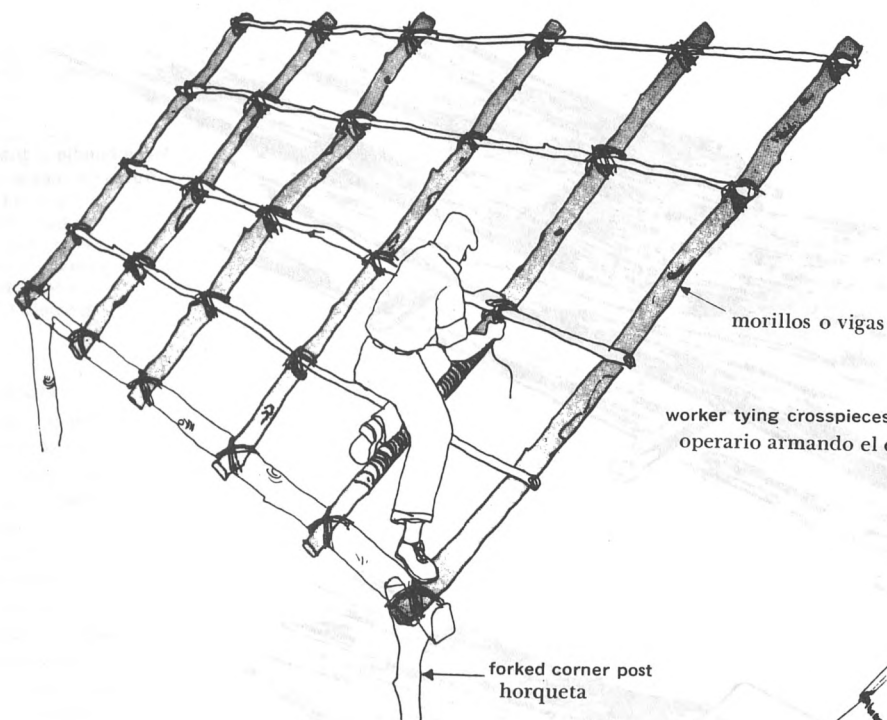

# Water Supply Systems

## Agua Para Usos Domesticos

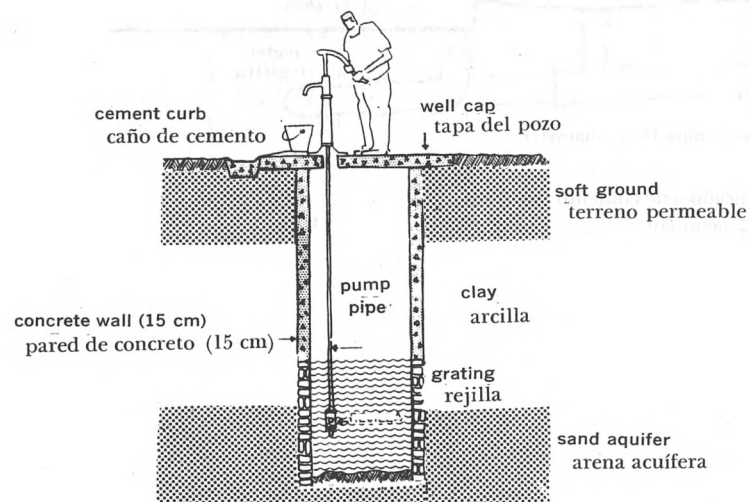
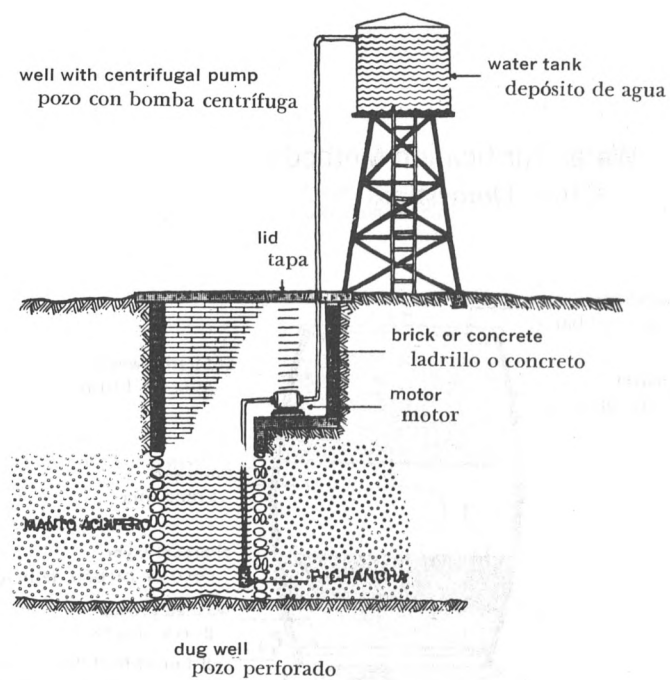
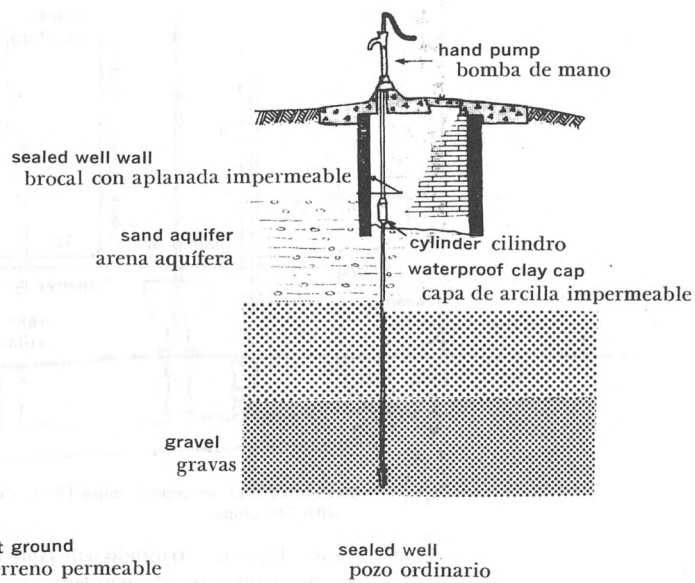
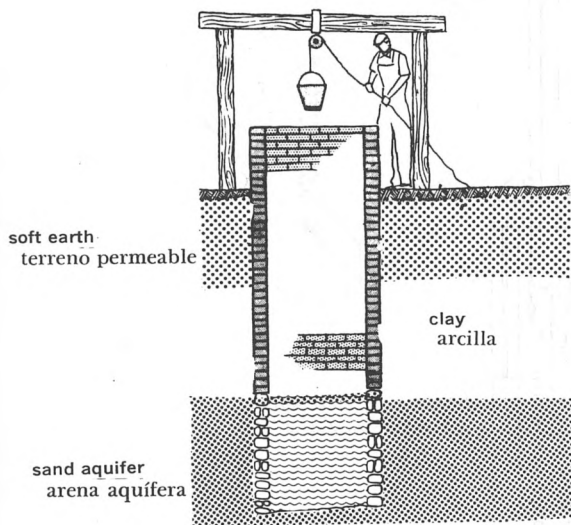
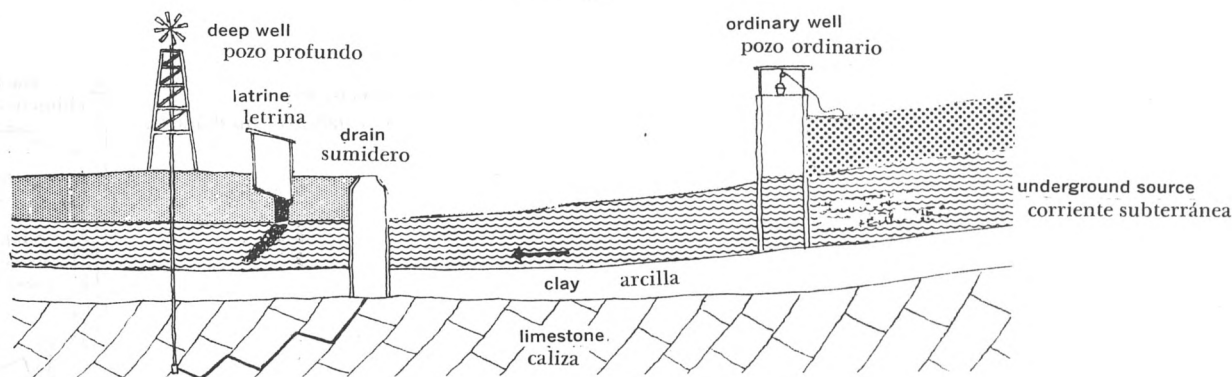

# House Plumbing System Instalación y Drenaje

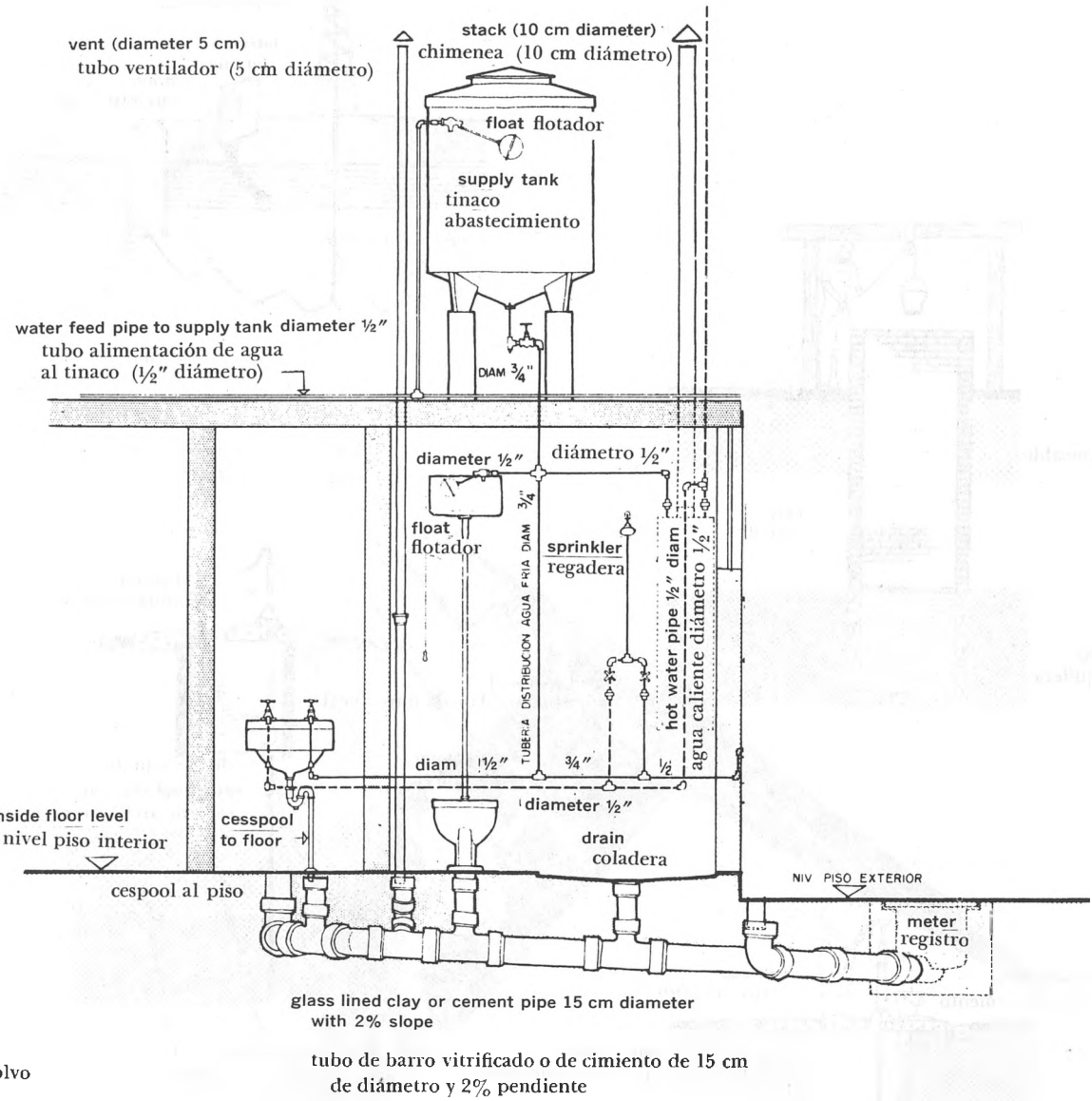

## Water Purification Methods Filtros Domésticos

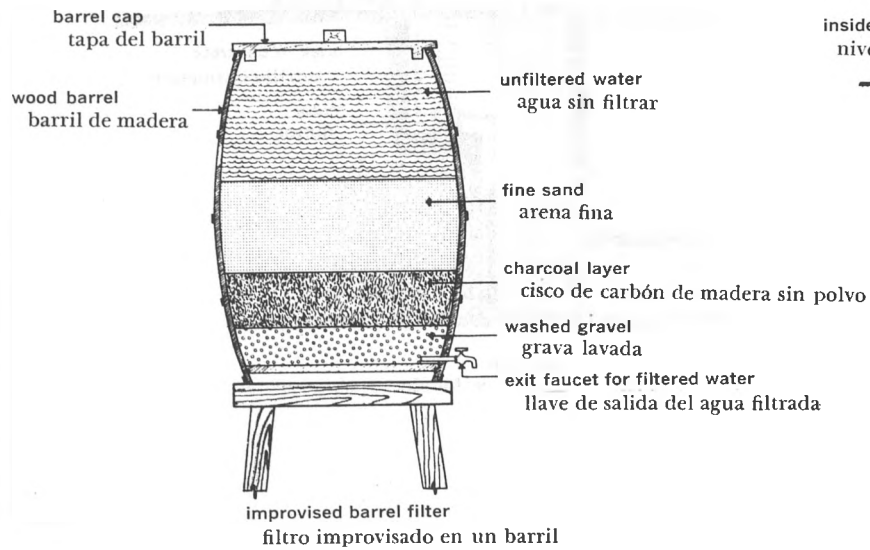

Plumbing  
Tubería

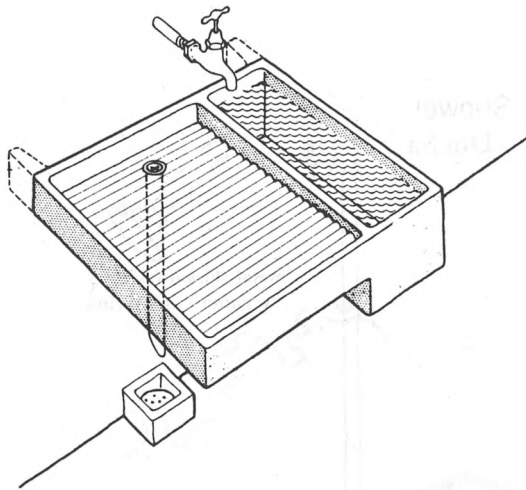

prefabricated concrete sink  
lavadero prefabricado de cemento

Kitchen  
Cocina

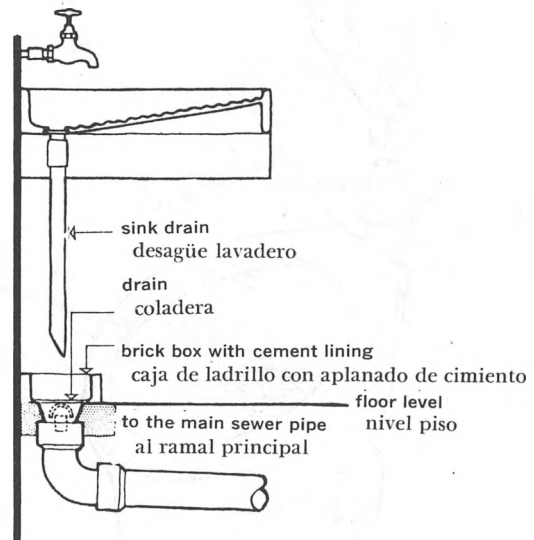

double lead trap with meter  
cespool doble de plomo con registro



simple lead trap with meter  
cespool sencillo de plomo con registro

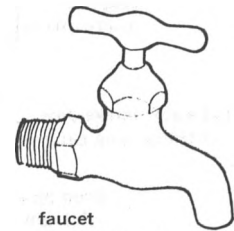

faucet  
llave de nariz

Bathroom  
Baño

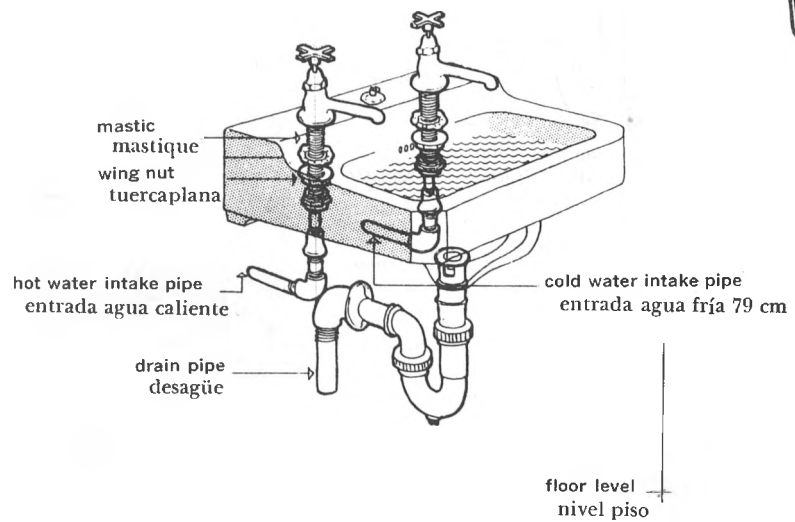
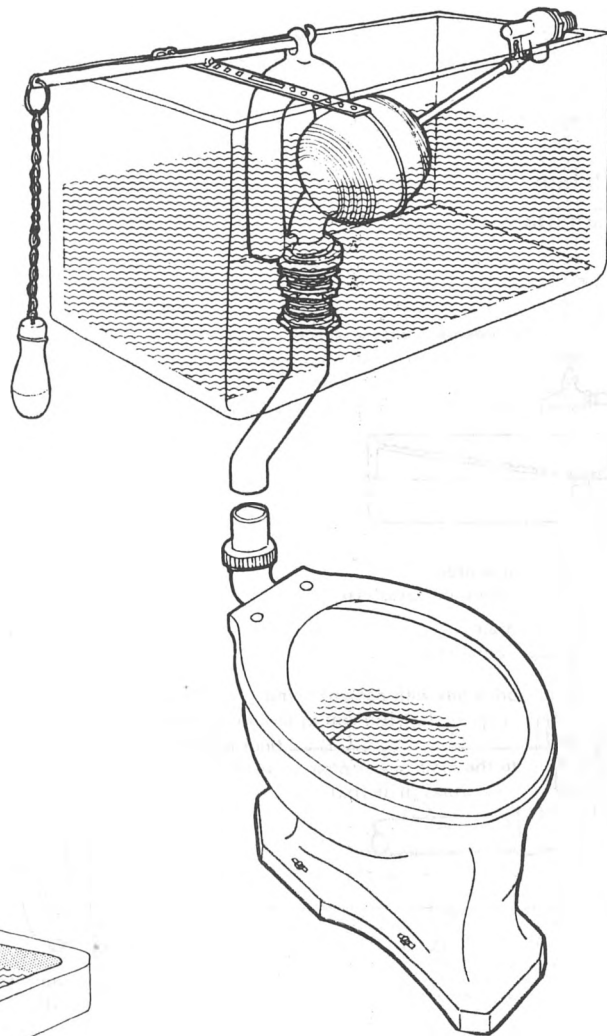

Shower  
Ducha

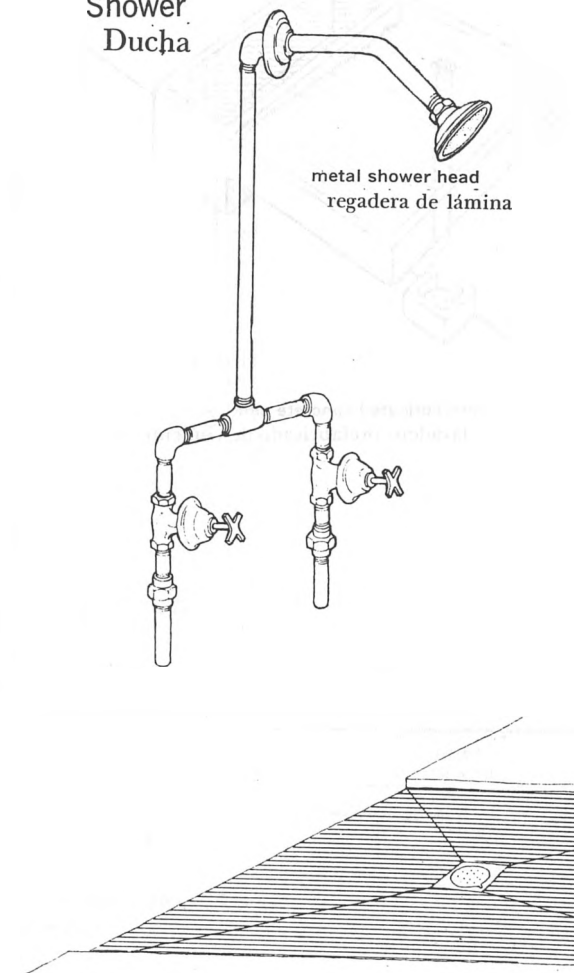

## Sewerage Disposal Systems Alcantarillado-Letrinas

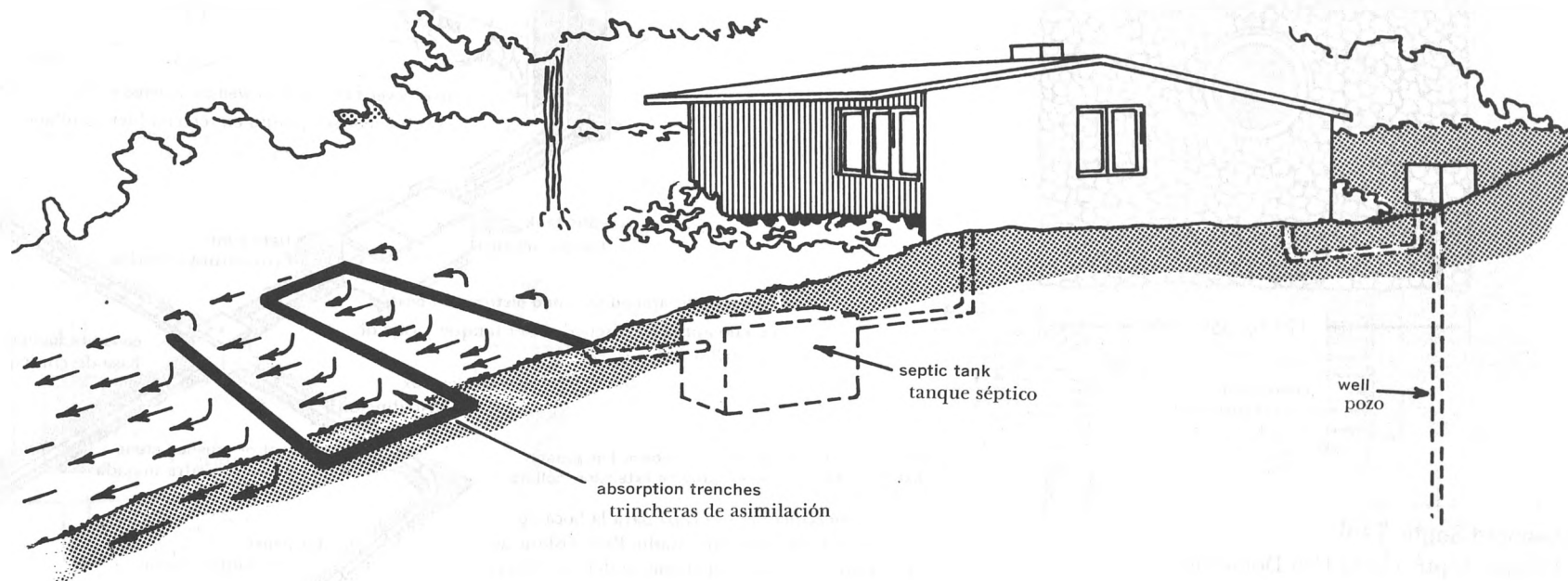

the well should be at a  
higher level than the  
septic tank system  
to protect it from  
sewage contamination

el pozo debe ser más alto que el  
alcantarillado para protección  
contra contaminación

Absorption Trench and Lateral  
Trinchera de Asimilación y Lateral

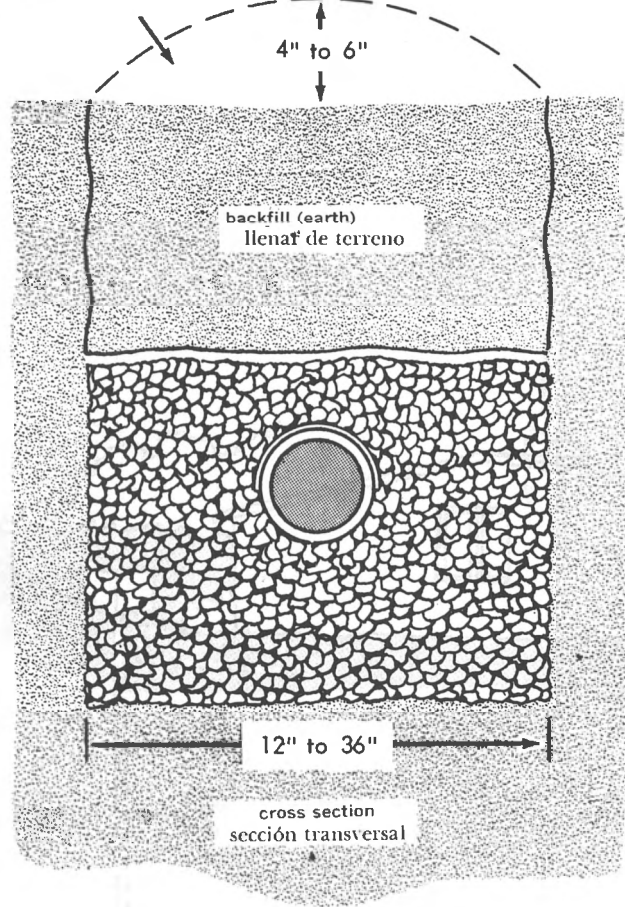

Household Septic Tank  
Tanque Séptico para Uso Doméstico

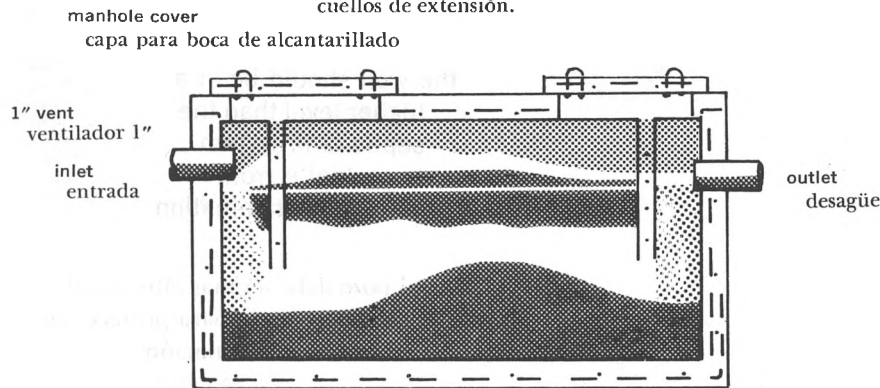

NB: make inlet at least 1-3" above outlet  
NB: la entrada debe ser 1-3" sobre el desagüe

Septic Tank Sewage Disposal Systems  
Sistema de Alcantarillado con Tanque Séptico

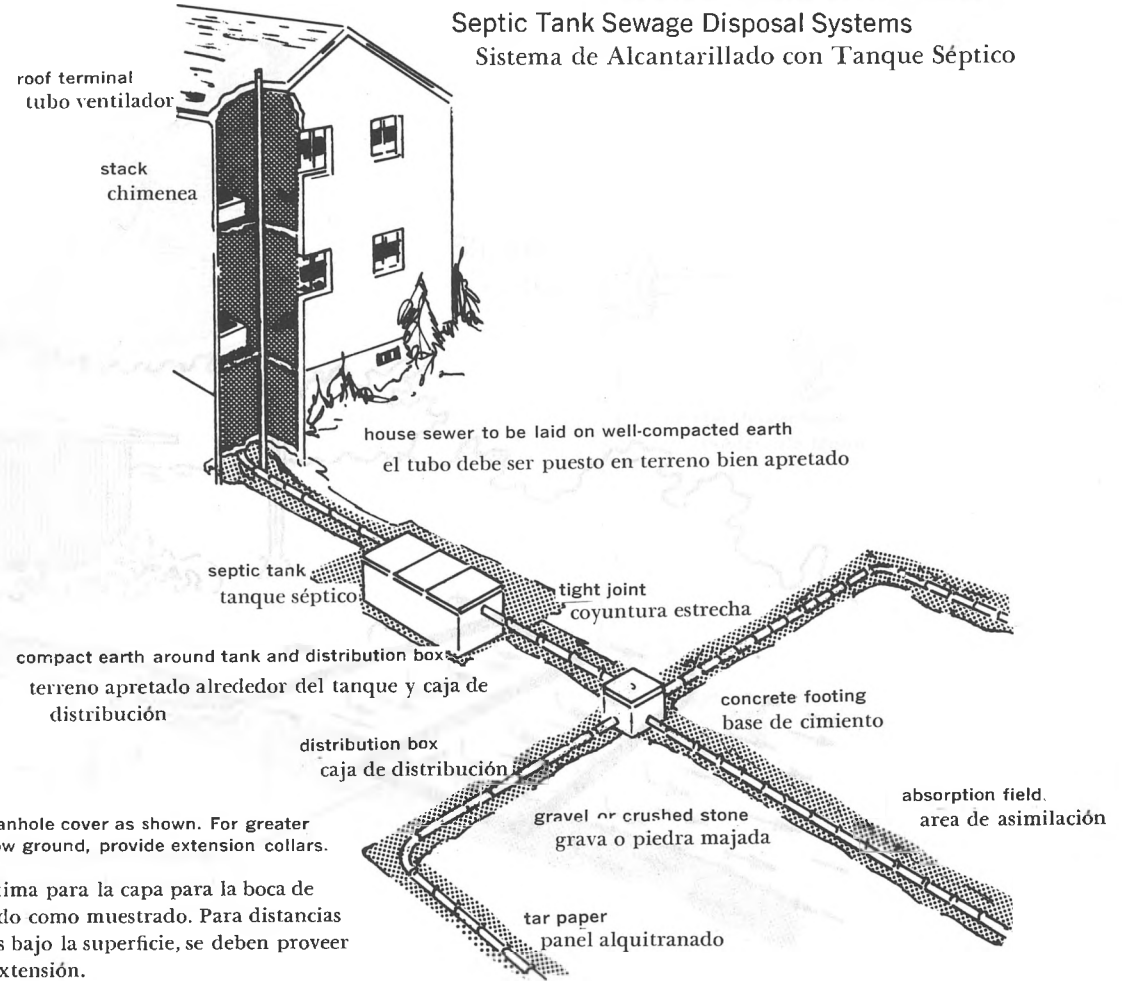

Maximum for manhole cover as shown. For greater distances below ground, provide extension collars.

Distancia máxima para la capa para la boca de alcantarillado como muestrado. Para distancias más grandes bajo la superficie, se deben proveer cuellos de extensión.

Penetration of outlet baffle generally 40% of liquid depth (for rectangular tanks)  
Penetración del ventilador generalmente 40% de la hondura del líquido (tanques rectangulares)

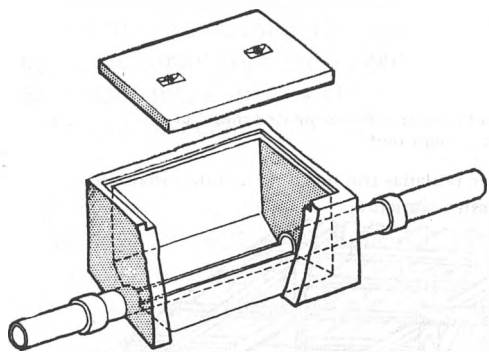

side view of junction box  
corte en perspectiva de un registro

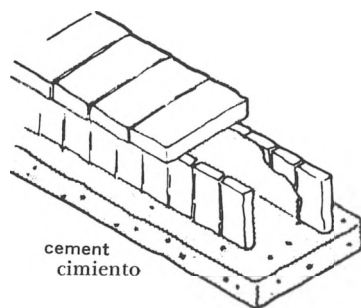

cement  
cemento

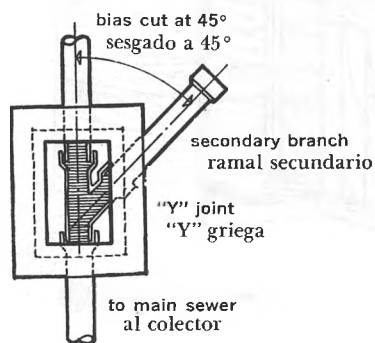
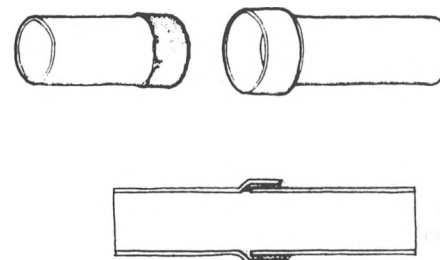

principal branch entry into junction box  
ramal principal de entrada al registro  
menos de 45°  
less than 45 degrees

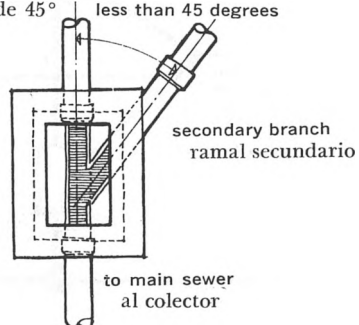

connection at less than 45 degrees  
conexión a menos de 45°

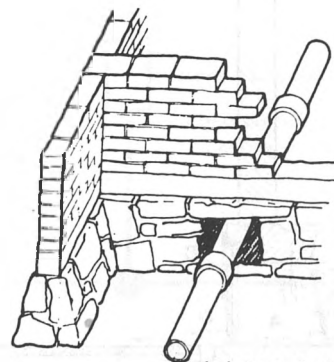

hole to protect the sewer from possible collapse  
Hueco para proteger el albañal de posibles hundimientos

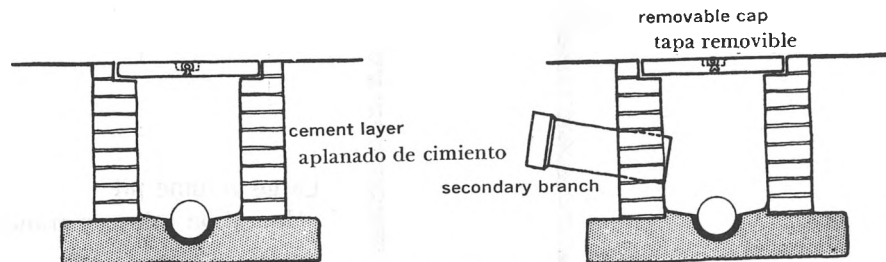
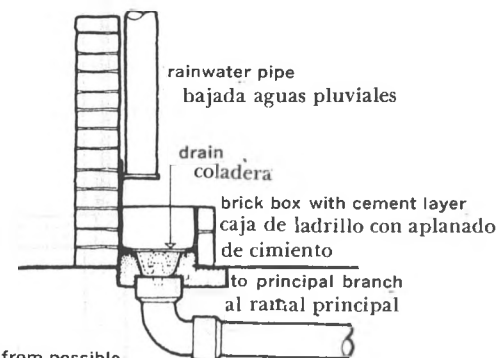

depth of medium sized junction box  
fondo de registro con medio tubo

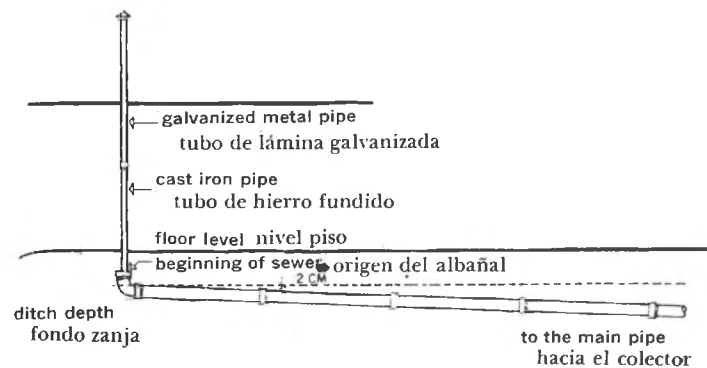

Outhouses or Latrines  
Alcantarillado-Letrinas

Bucket Latrine  
Letrina a Pozal

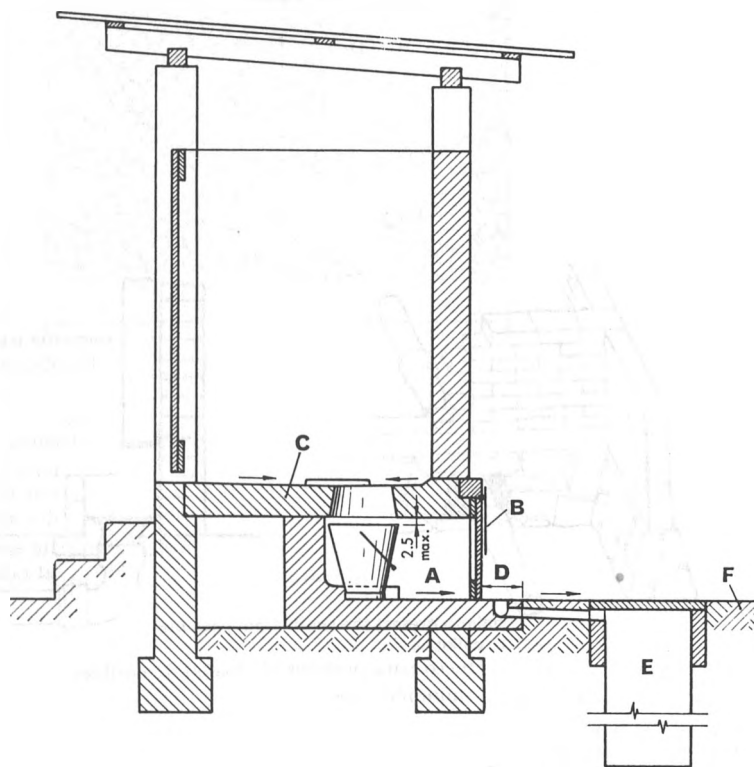

latrine of cut lumber with corrugated metal or  
asbestos cement roof

letrina de tablas con techo de metal acanalado  
o asbestos-cimiento

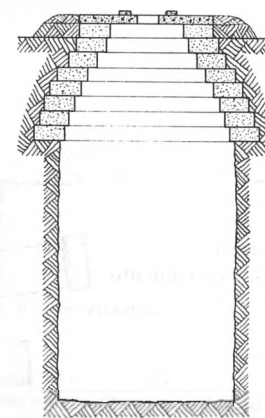
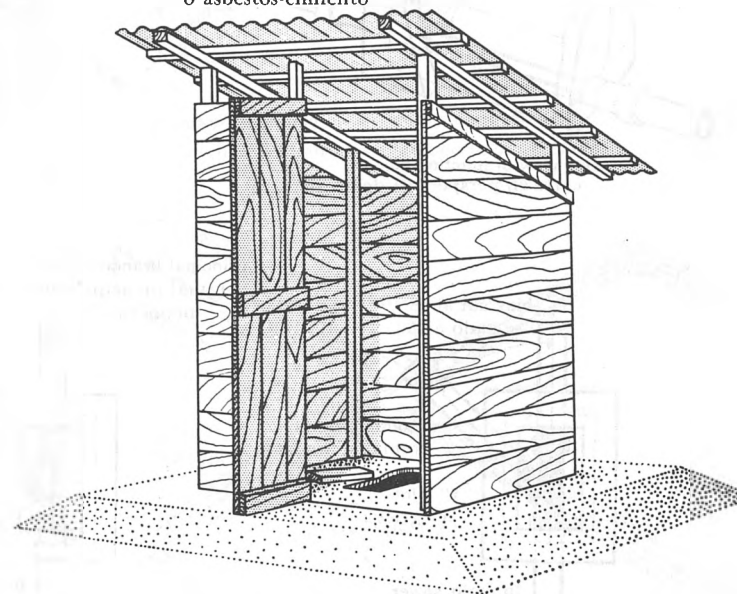

Large volume pit  
Hueco con volumen grande

# Electrical Systems

## Sistemas Electricos

A three wire system is used in homes to provide both 120 and 240 volts. 120 volts is used for lights and small appliances. 240 is used for large appliances such as electric stoves, water heaters, etc.

Un sistema a tres alambres se emplea en casas para 120 and 240 voltios. Se emplean 120 voltios para las luces y recipientes. 240 voltios se emplean para estufas eléctricas, etc.

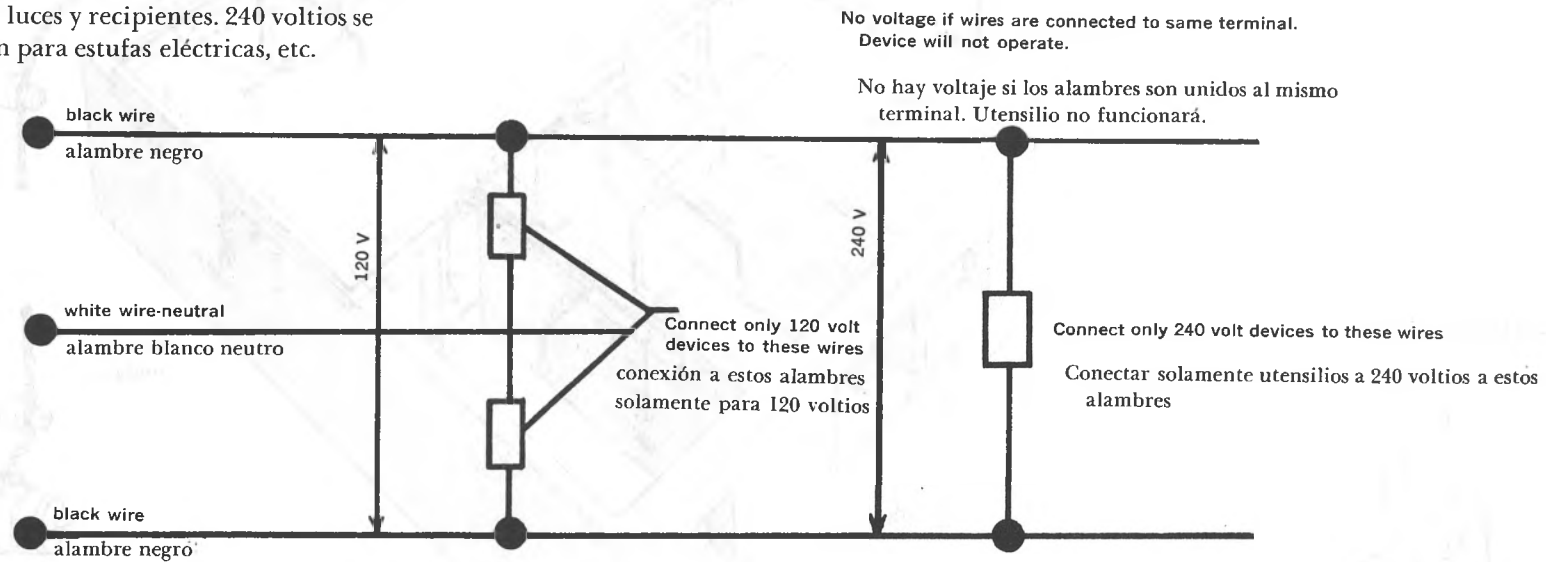

Switch Box  
Toma de Corriente

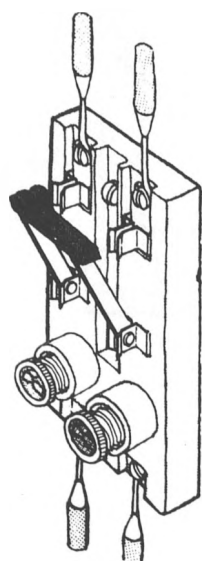

fuse  
tapón fusible

two-fuse circuitbreaker  
interruptor de navajas con fusibles, dos polos

for inside installation  
a la instalación interior

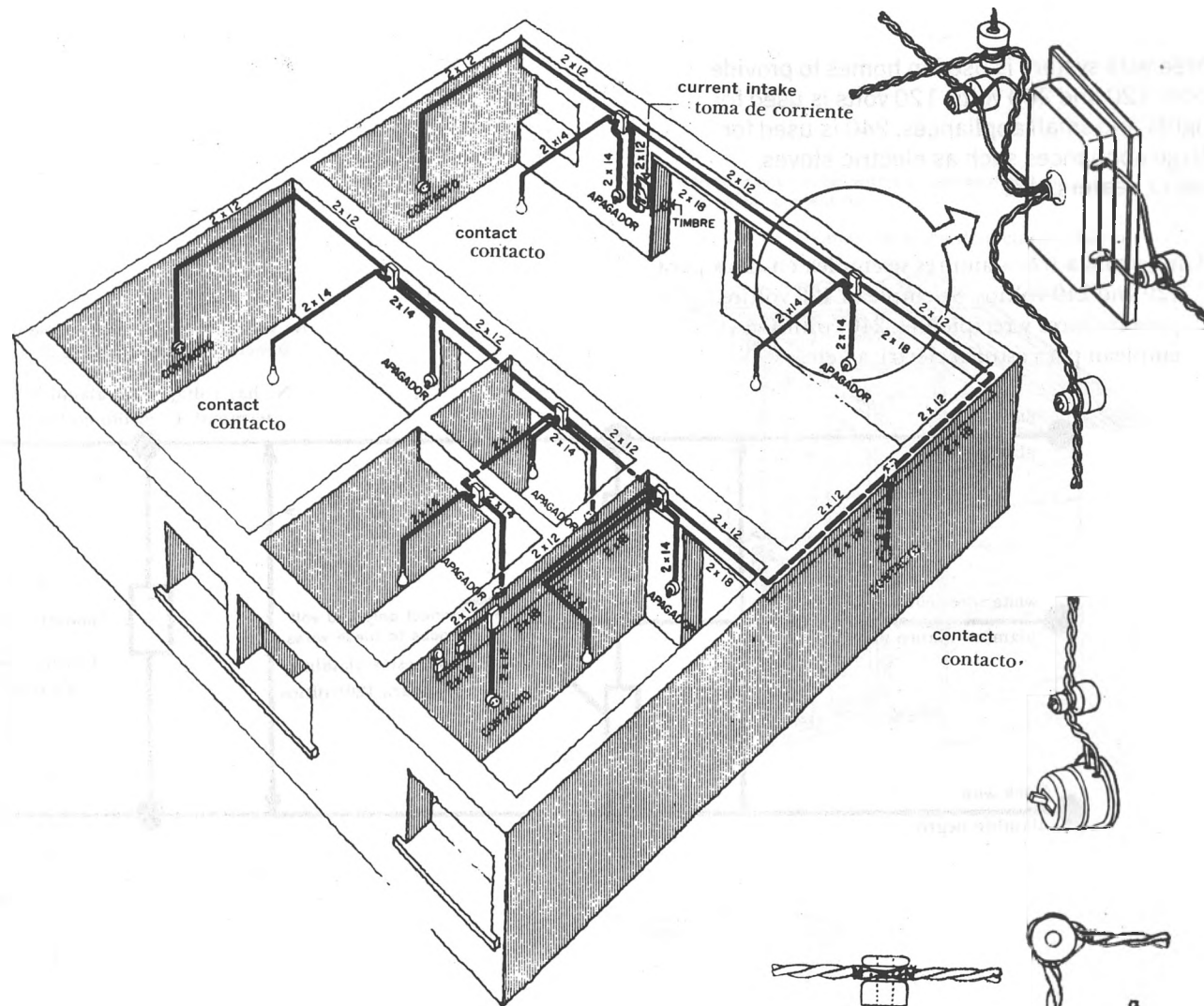

current intake  
toma de corriente

contact  
contacto

contact  
contacto

contact  
contacto

attaching the wires to the insulators  
amarre de cordón en aisladores

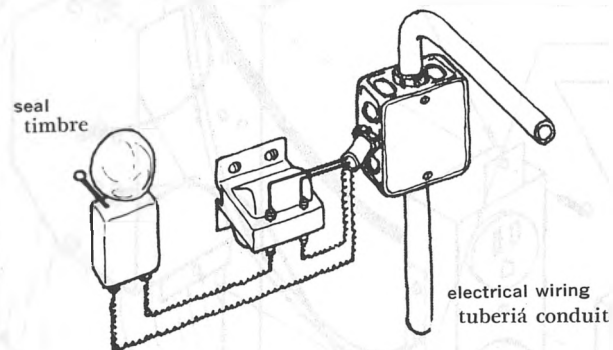
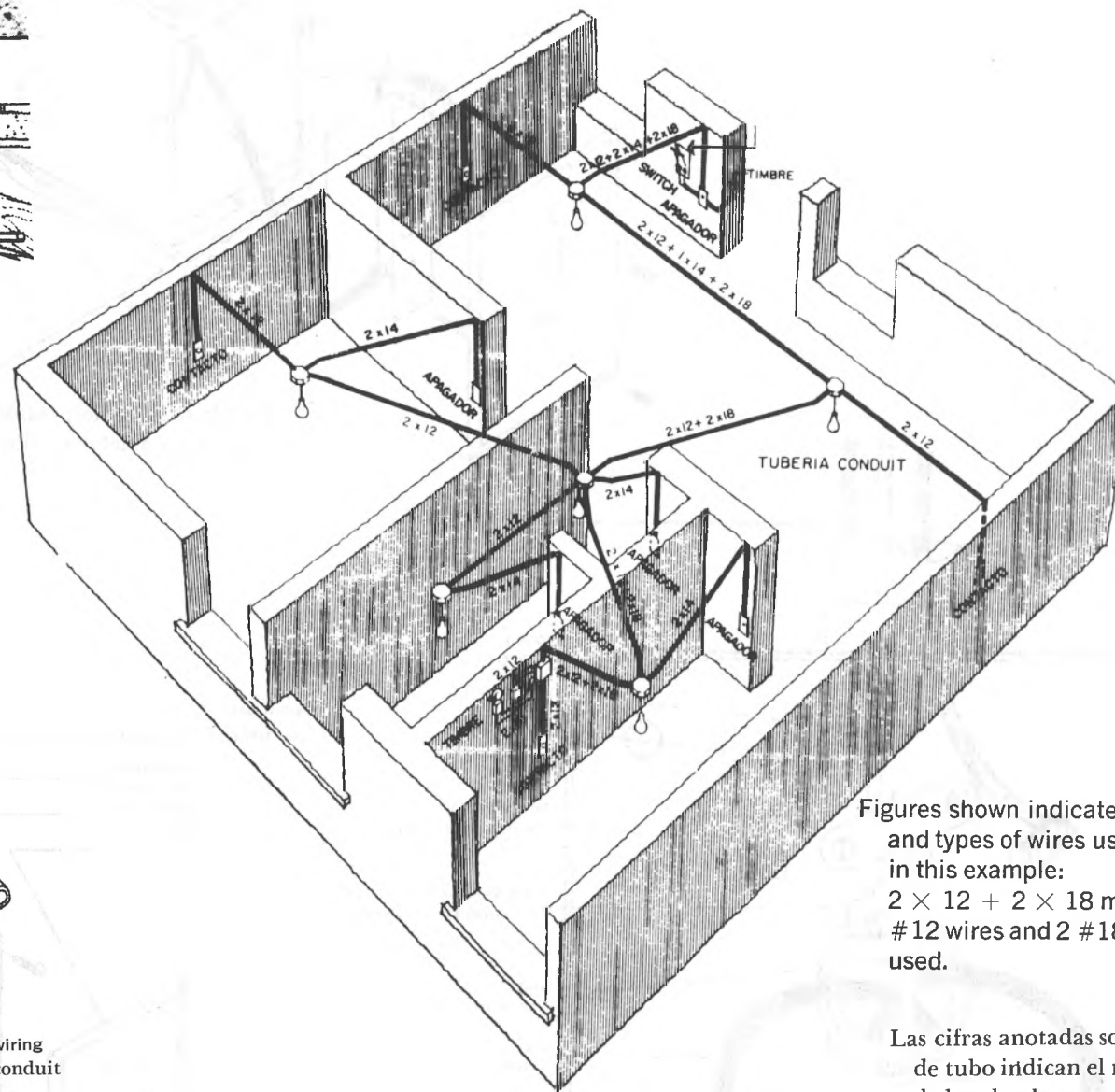
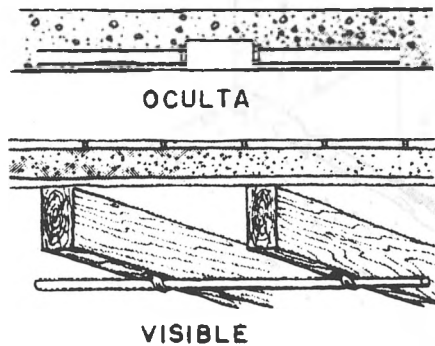

Figures shown indicate the number and types of wires used in this example:  
 $2 \times 12 + 2 \times 18$  means that two #12 wires and 2 #18 wires were used.

Las cifras anotadas sobre cada tramo de tubo indican el número y calibre de los alambres que van en ese tramo (ejemplo:  $2 \times 12 + 2 \times 18$  significa que se pondrán 2 alambres del 12 y 2 alambres del 18.)

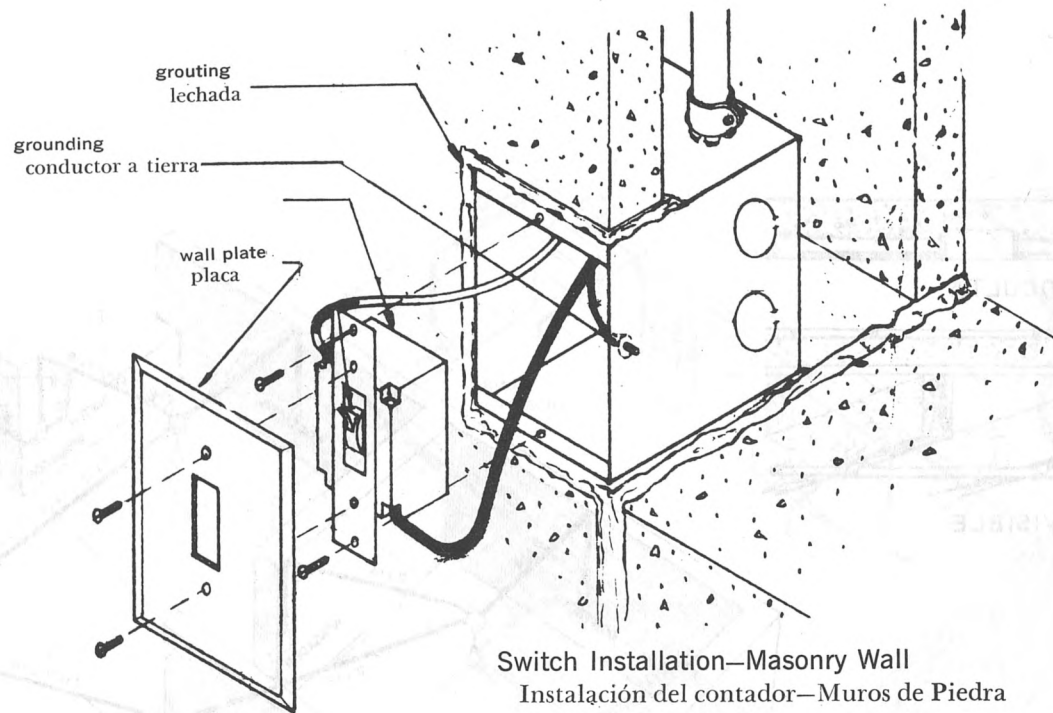

Switch Installation—Masonry Wall  
Instalación del contador—Muros de Piedra

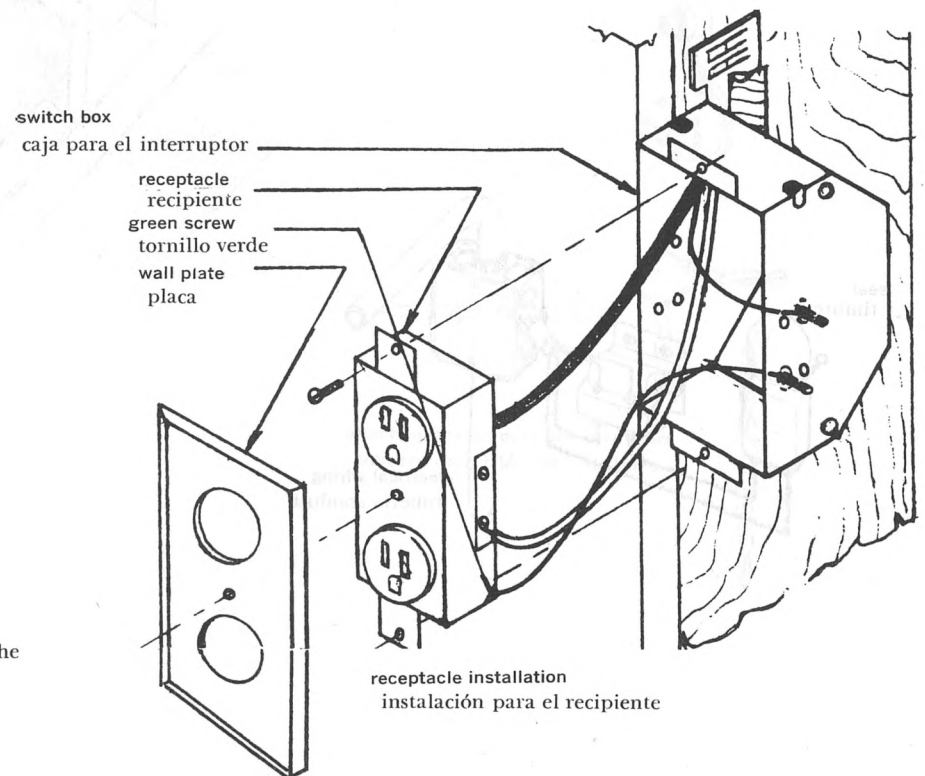
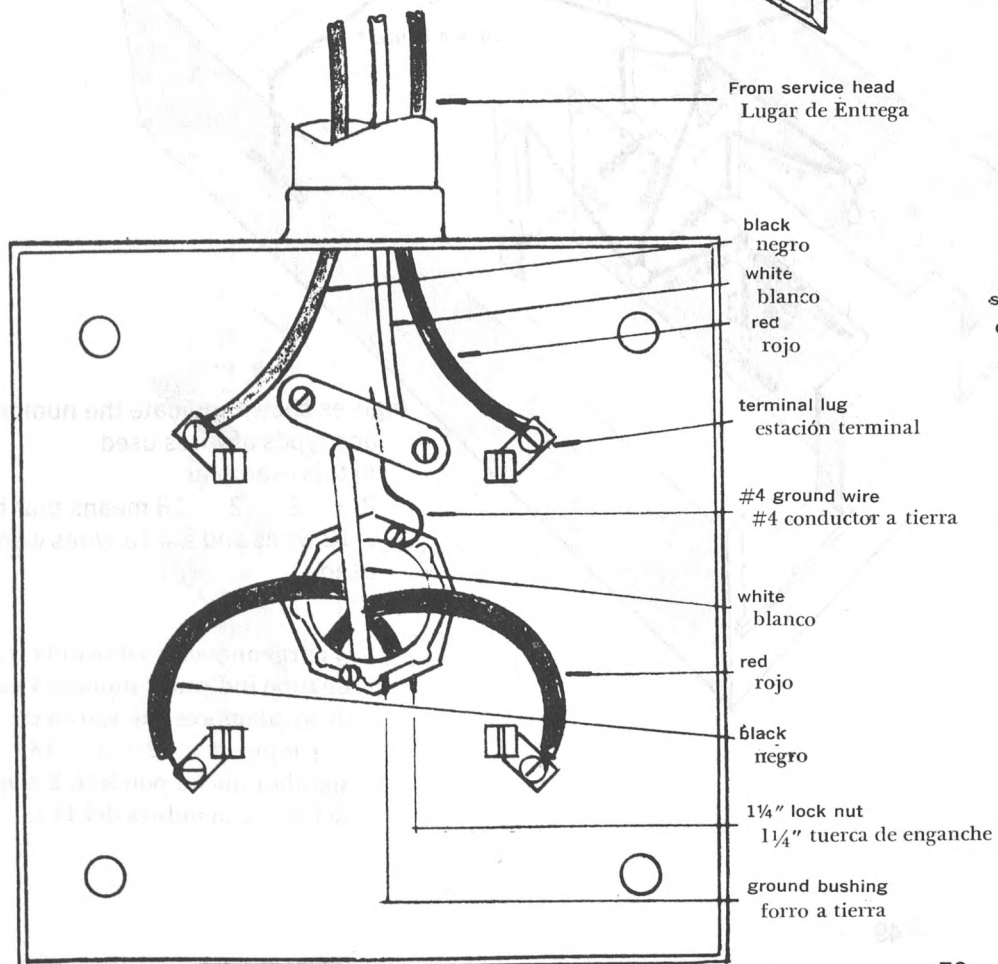

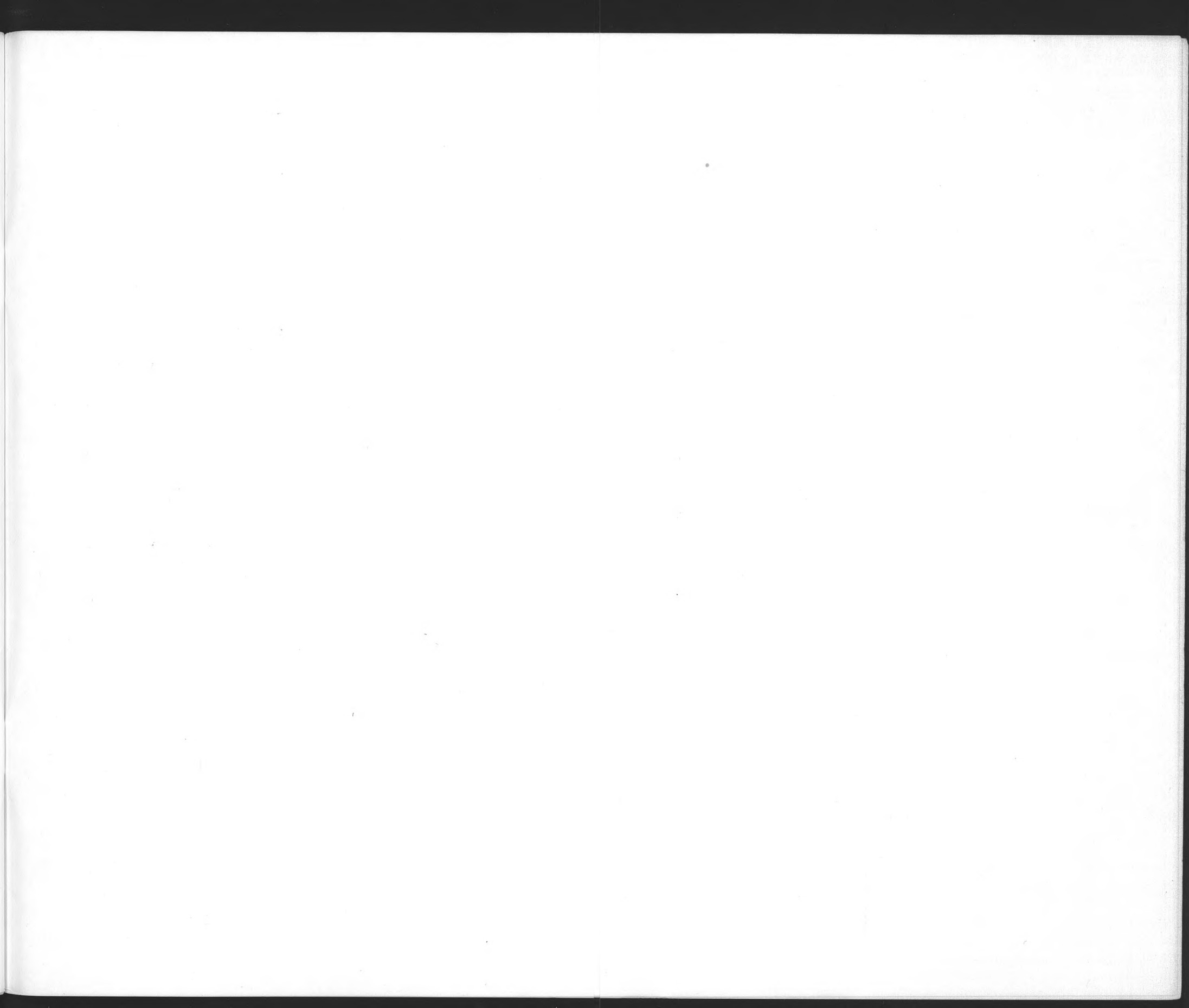

U. S. Department of  
Housing and Urban Development



Office of  
International Affairs

