

1

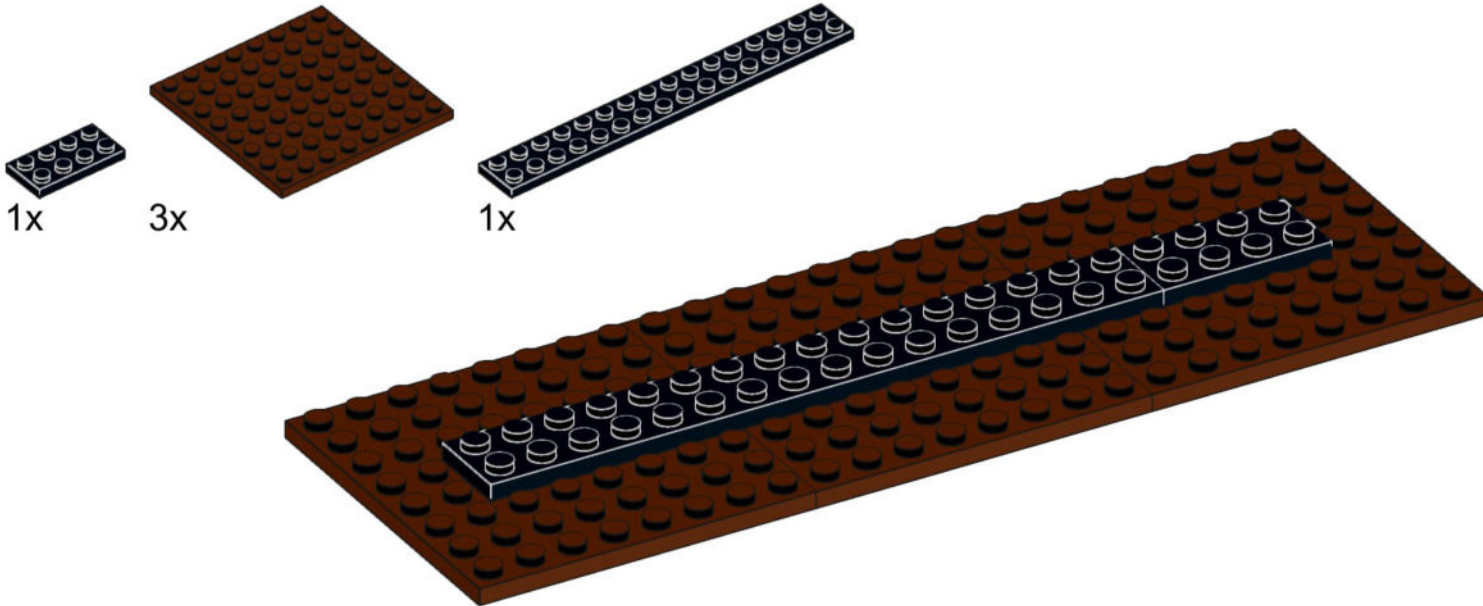

2

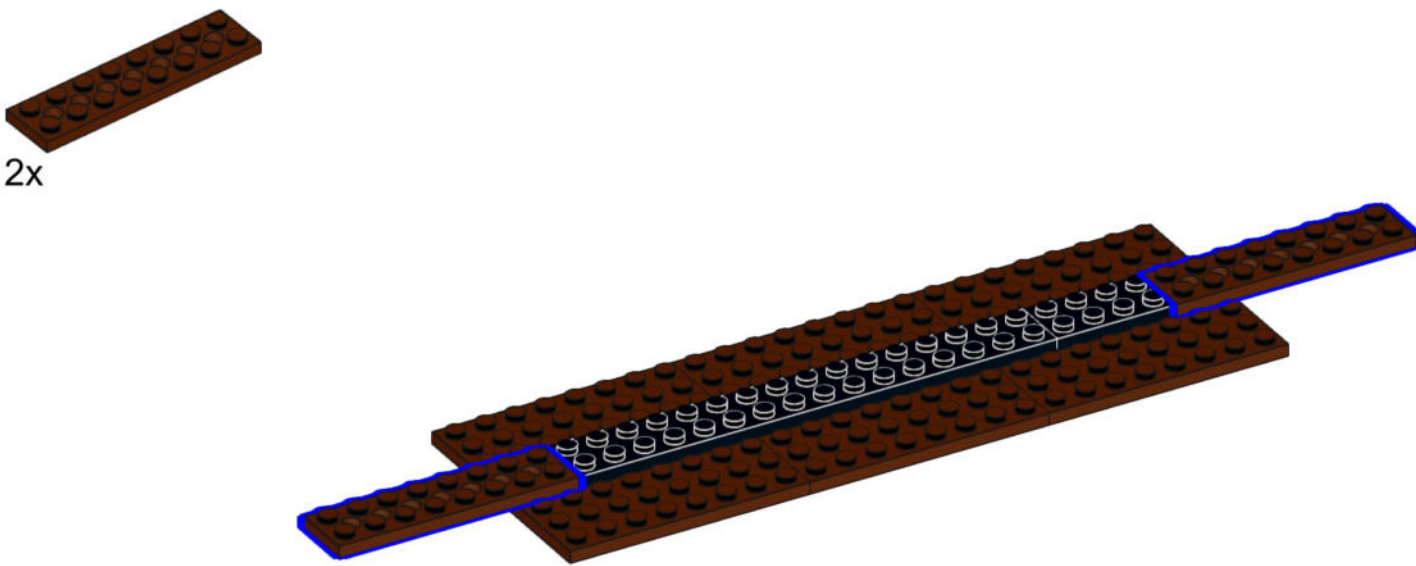

3

2x



2x



2x

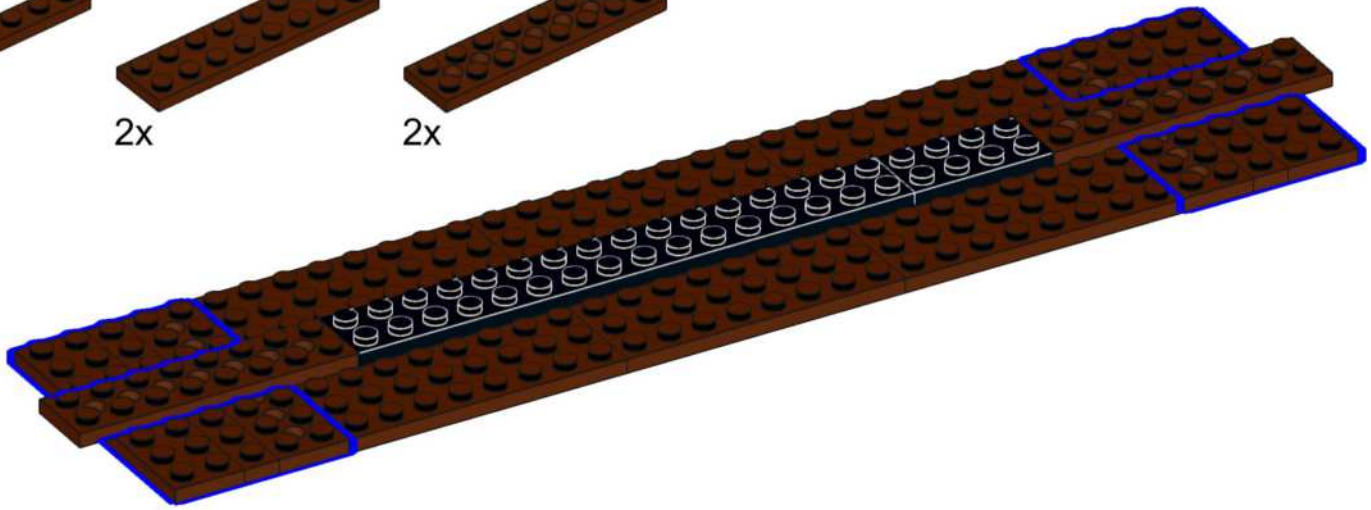

4

4x

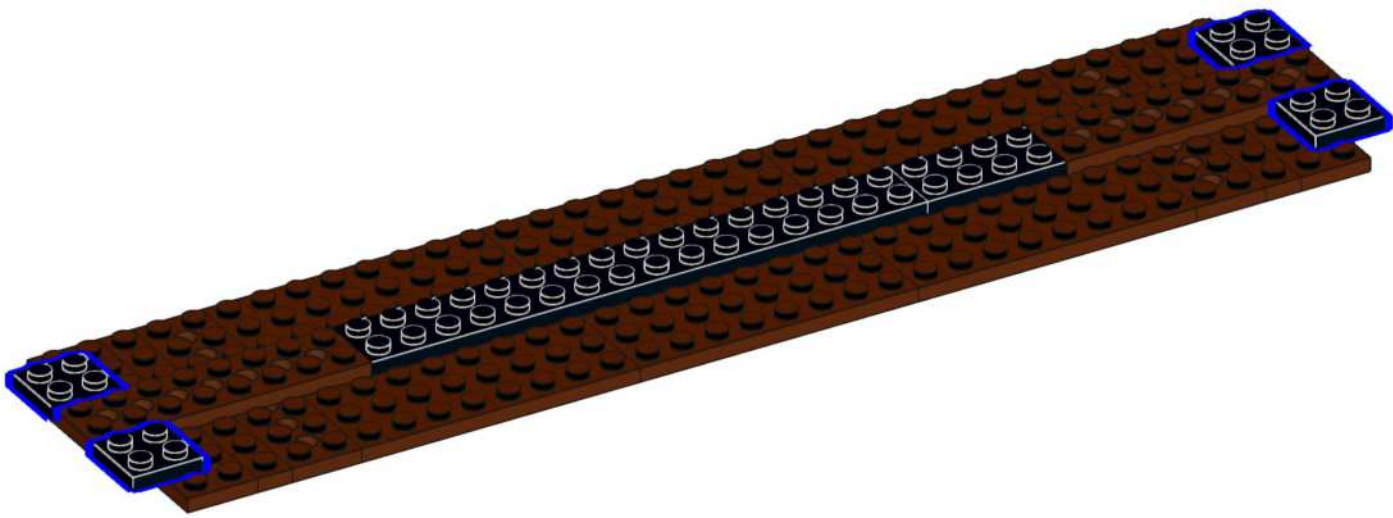
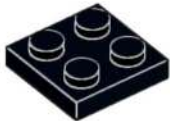

5

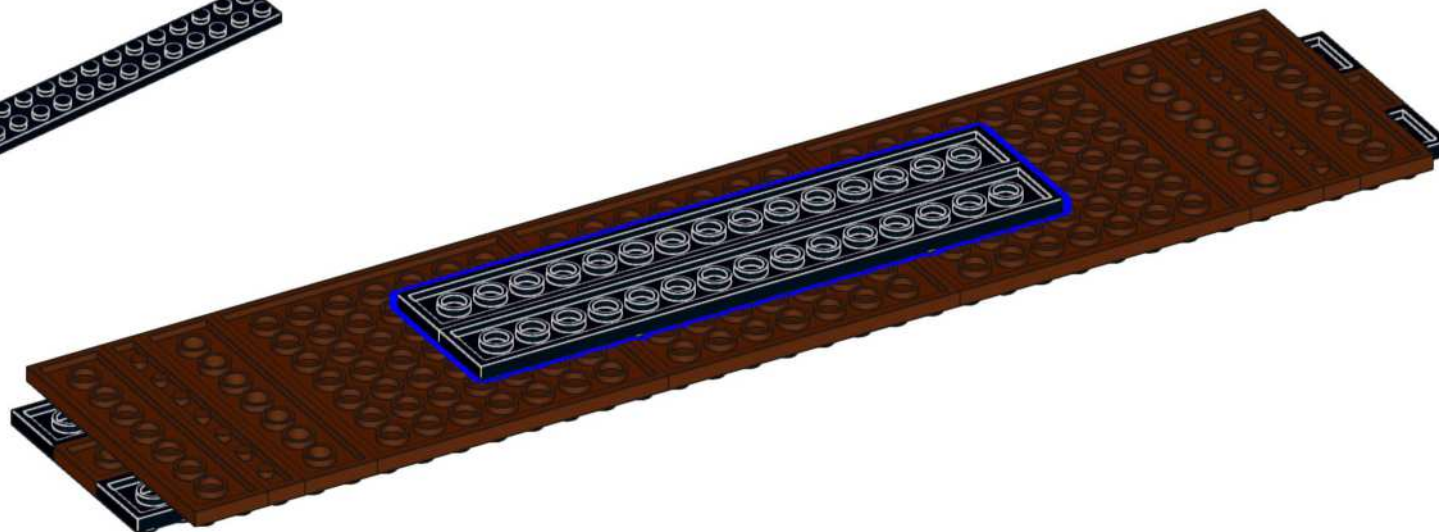

6

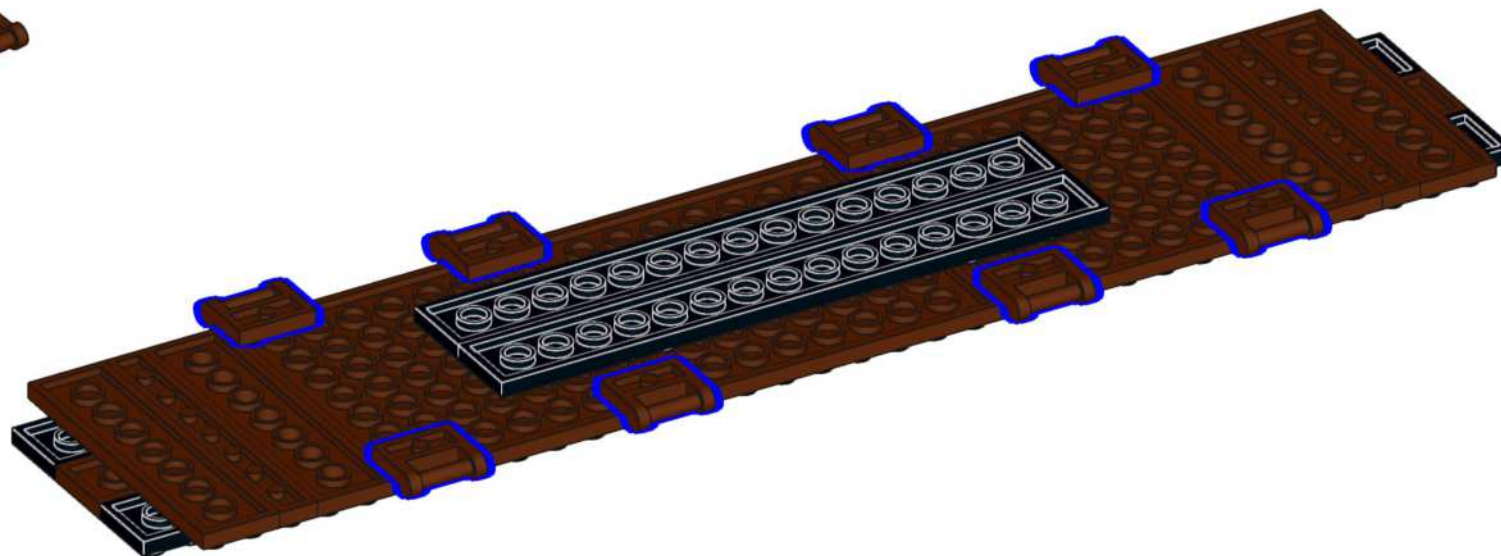

7

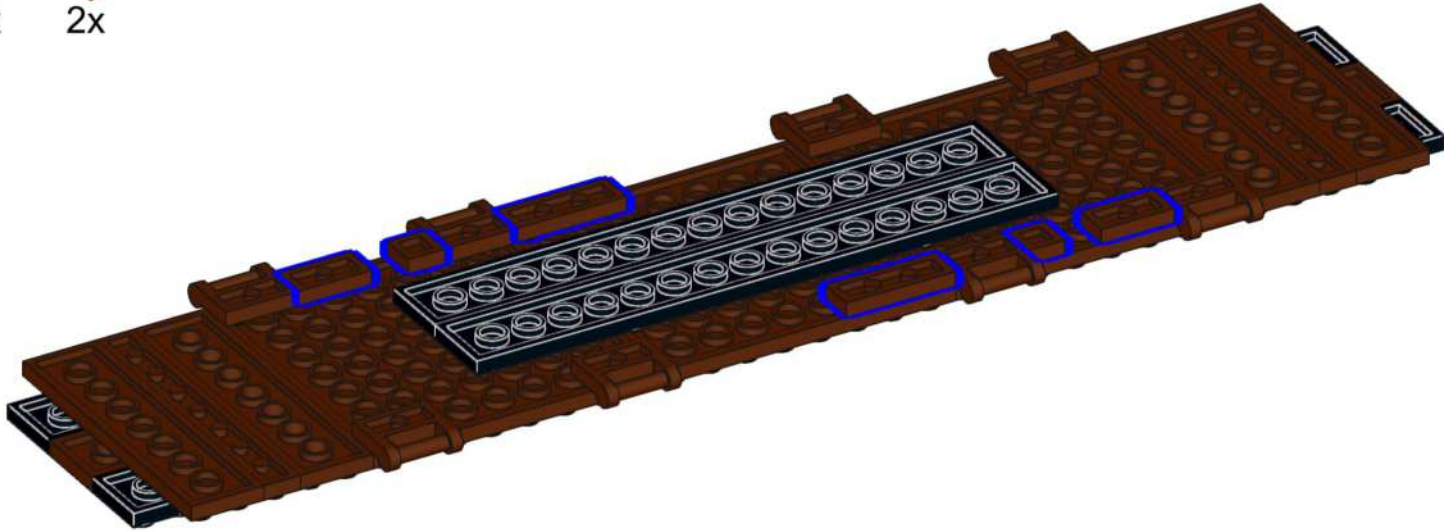
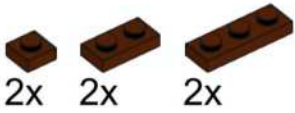

8

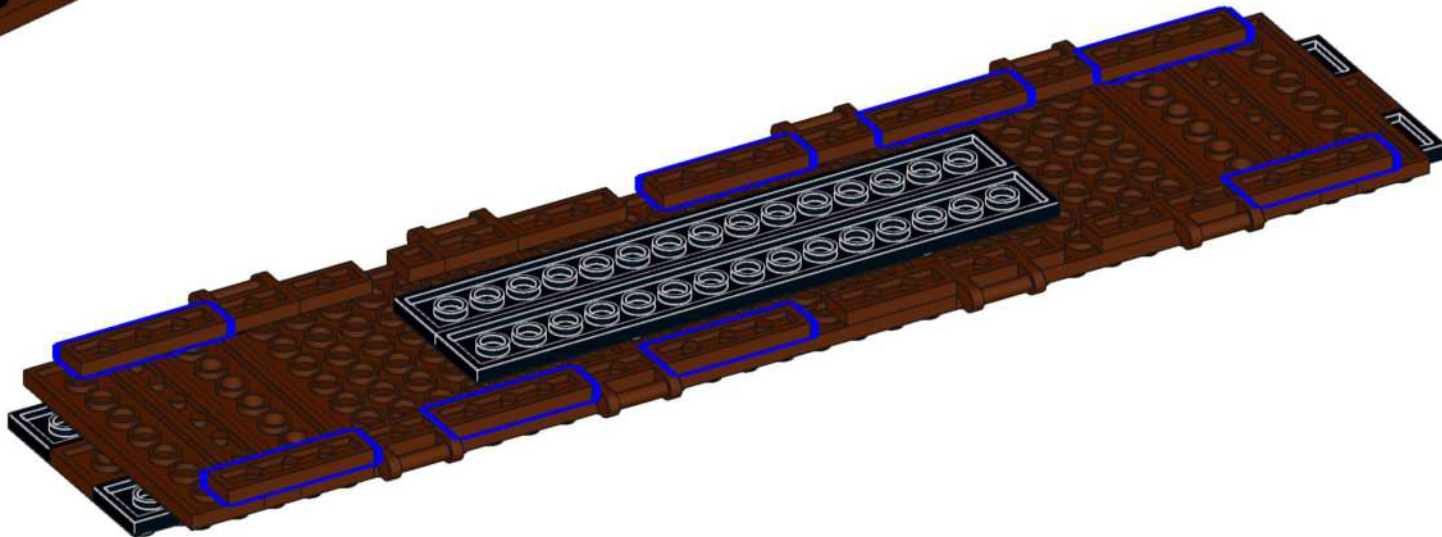
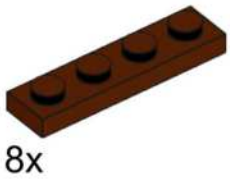

9



1x



1x

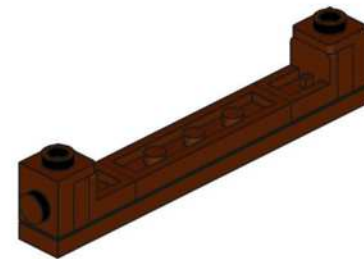

X2

10



1x



2x

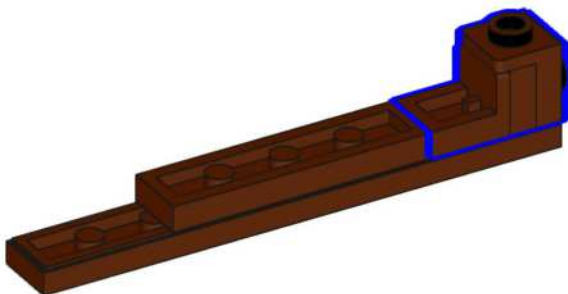

11



1x



2x

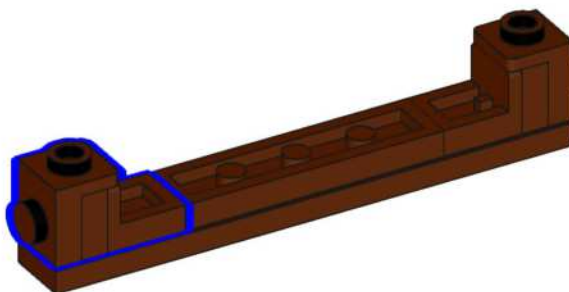

12

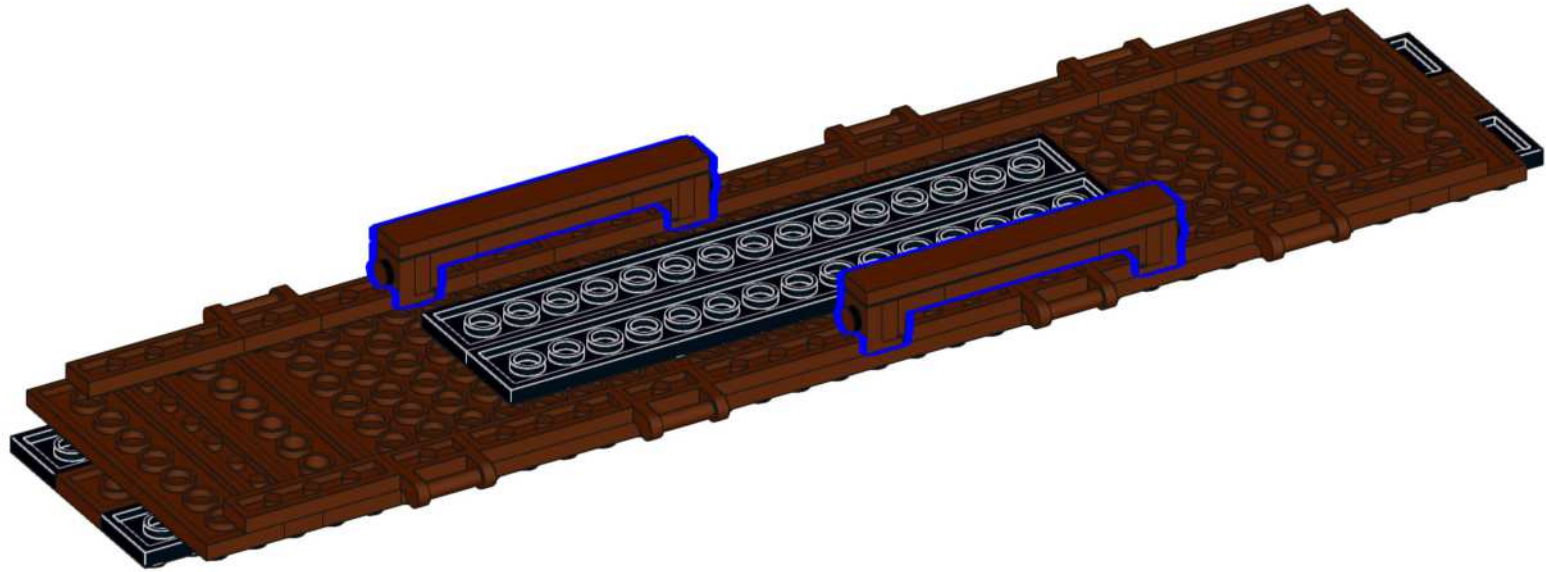

13

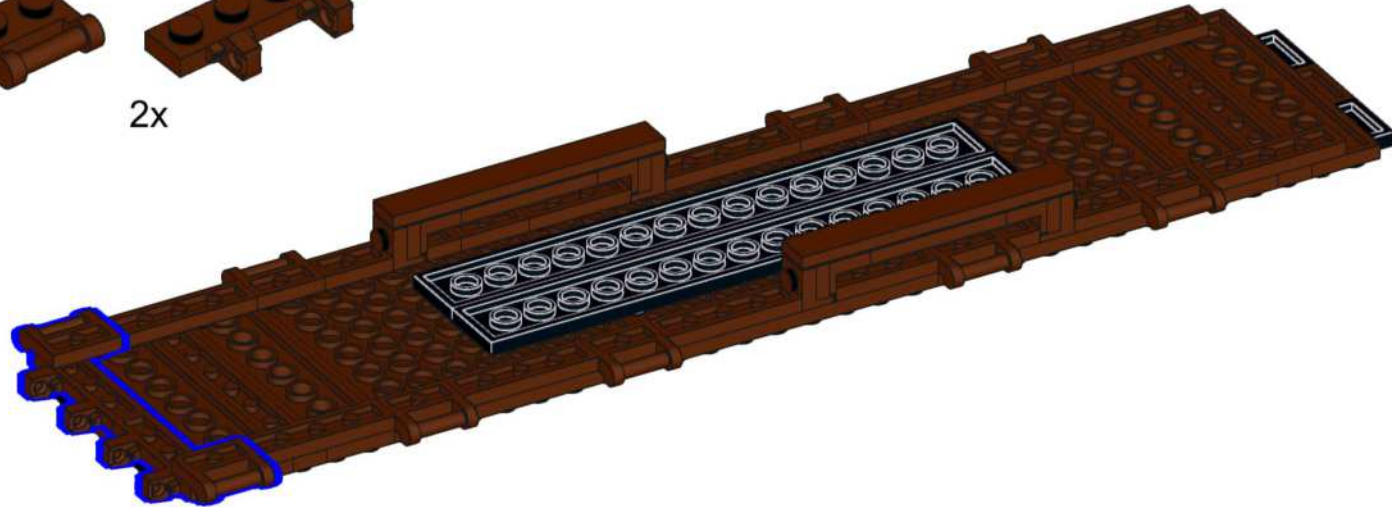
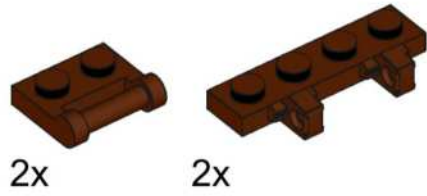

14

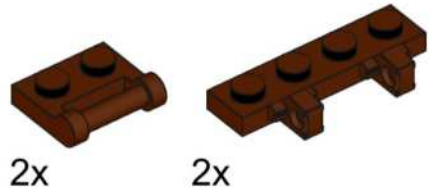

15

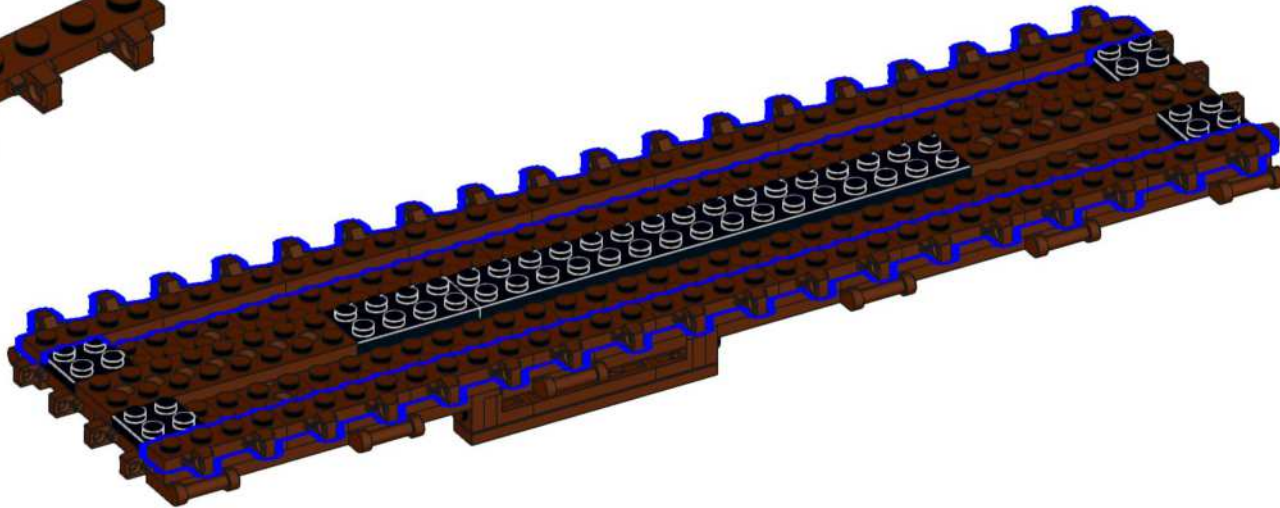
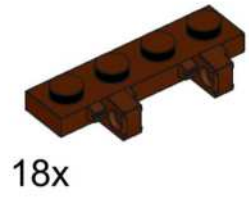

16

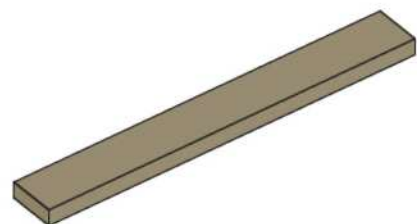

36x



17



22x

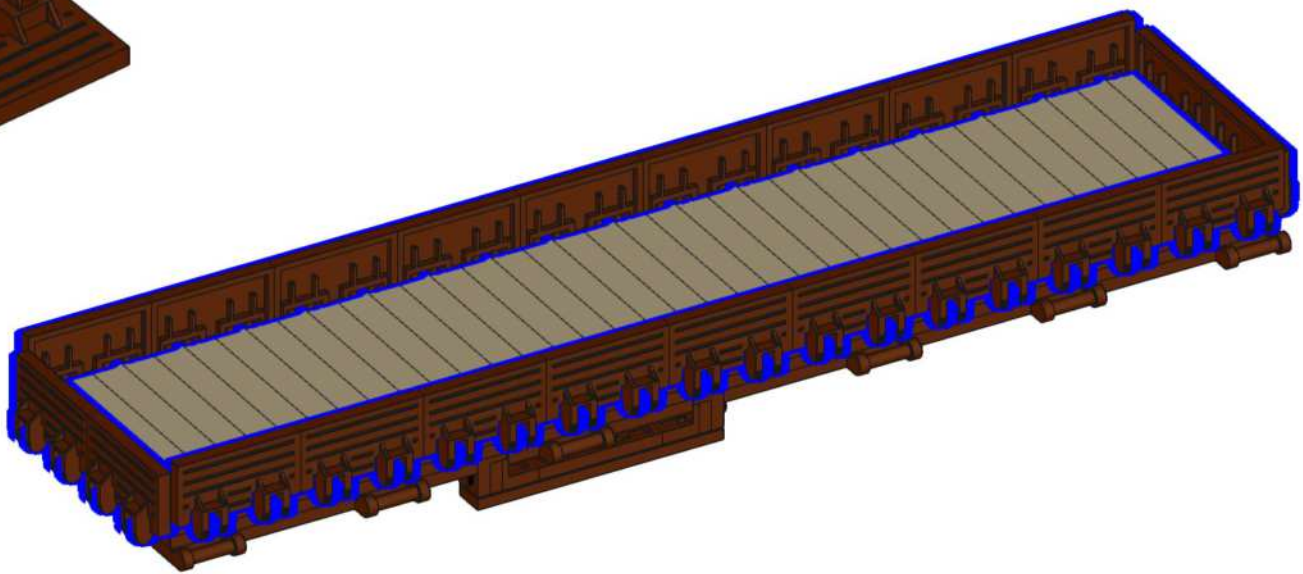

18

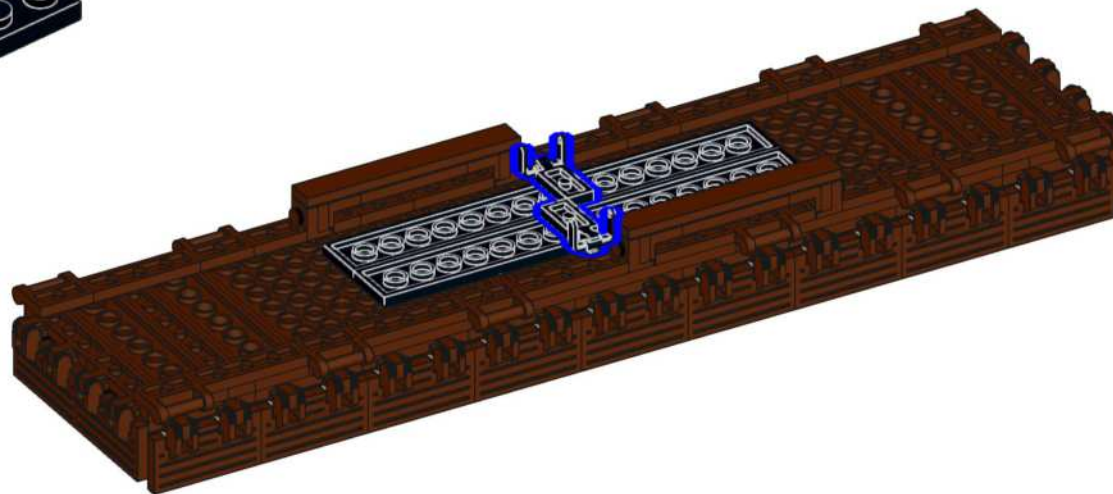
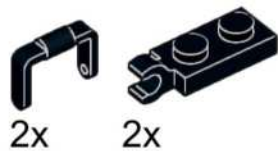

19

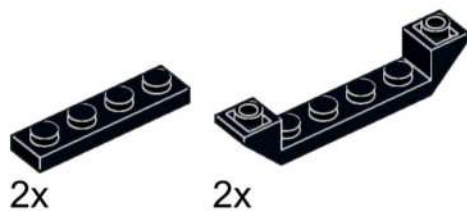

20



4x



4x



21



4x



4x



22

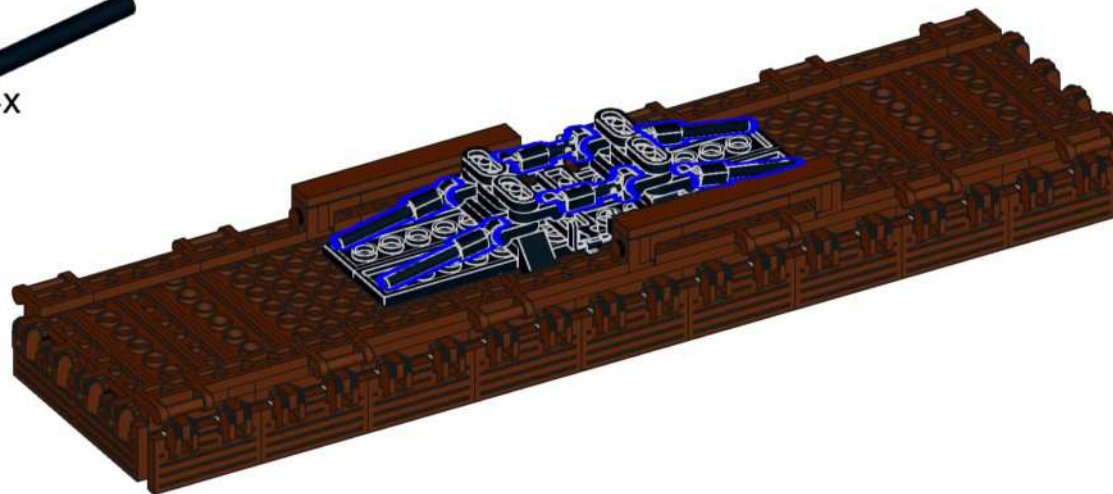
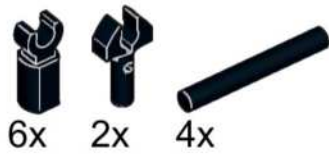

23

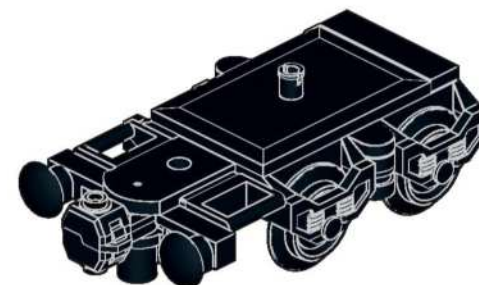
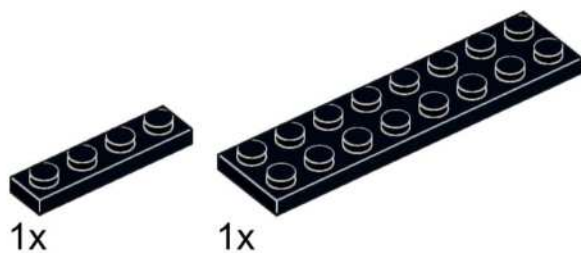

X2

24

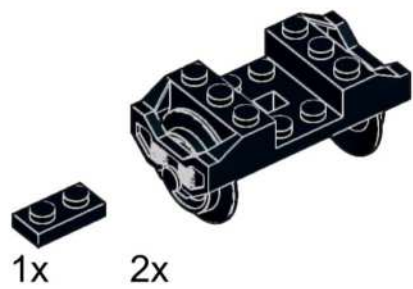

25

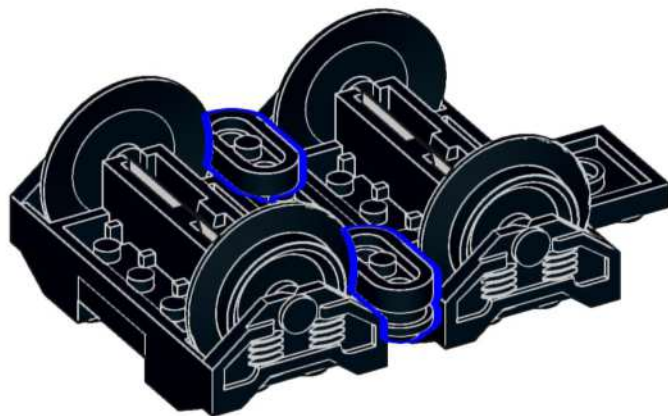

26

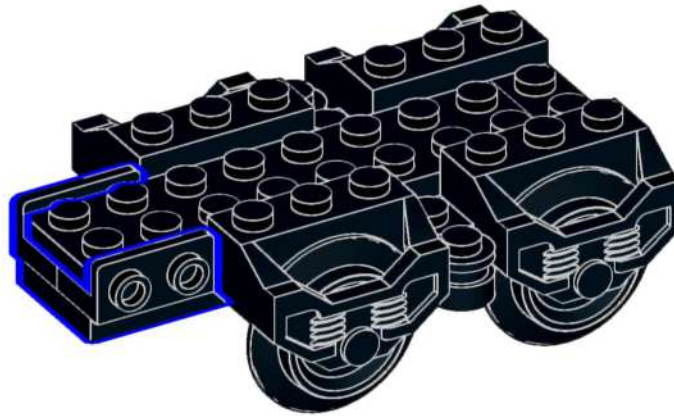
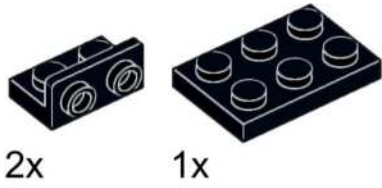

27

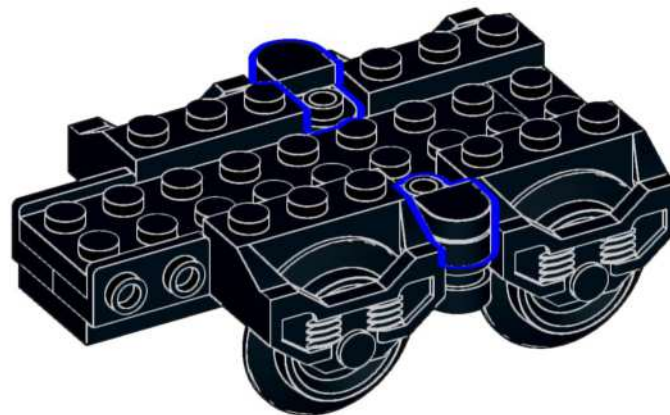

28

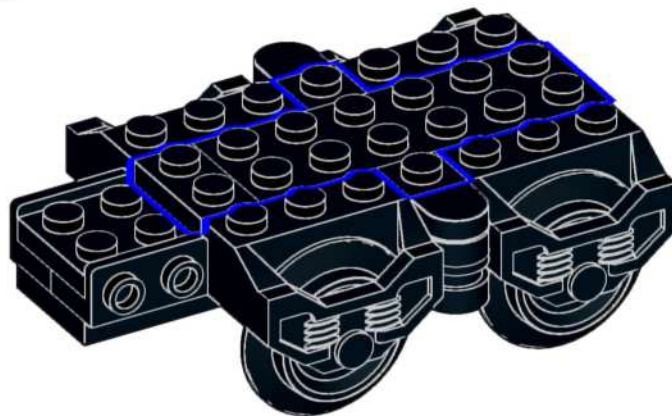
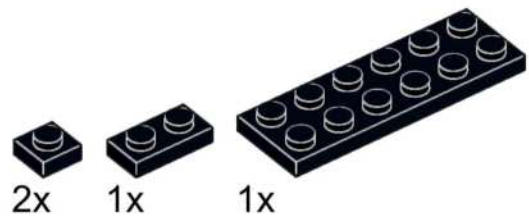

29

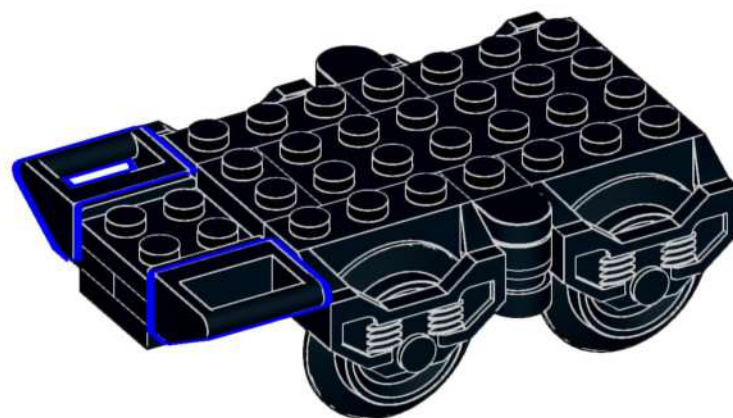

30

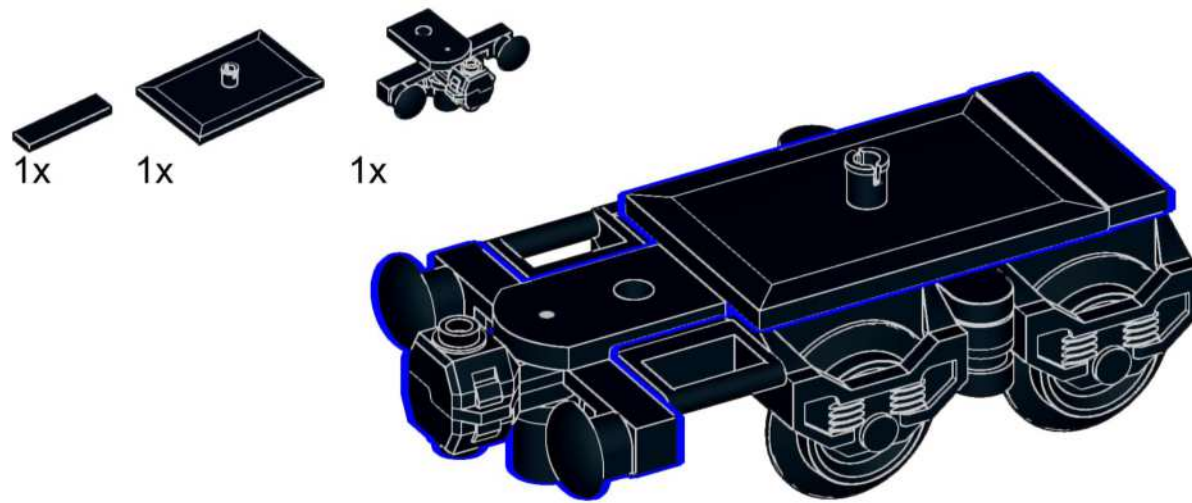

31

